

Type 2700, 2600 Series

Substation straight terminals are designed for limited space applications as found in substations. Terminals are shorter than conventional terminals which saves space and allows for faster installation. Terminals are installed with standard AFL hex dies. Terminals can be supplied pre filled if required.

Notes

Other pad sizes can be custom ordered.



2600



2700

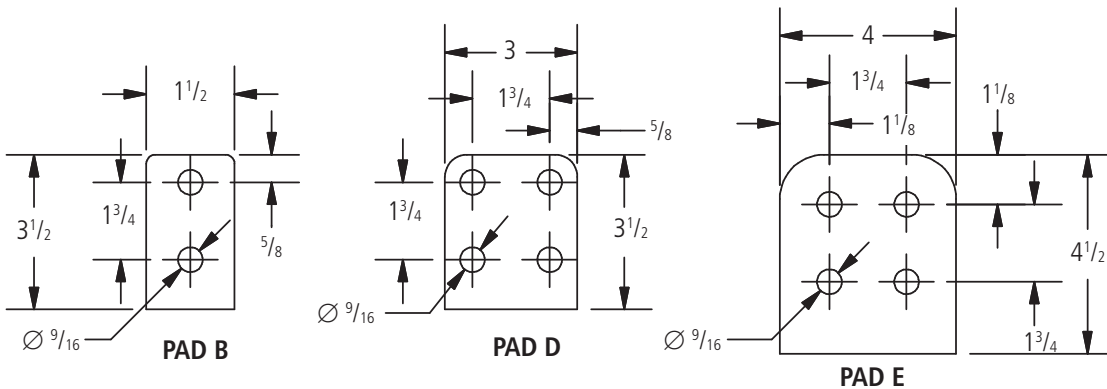
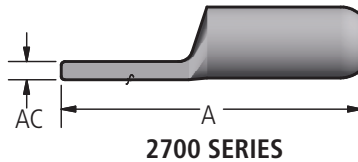
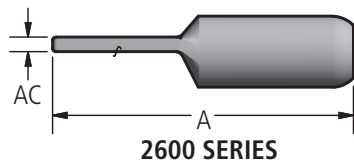

Ordering Information

Catalog Number		Conductor Range			Pad Size	Dimensions in Inches		Die size	Nominal Weight lbs
Offset Pad	Center Formed Pad	Diameter	AAC	ACSR		A	AC		
2776.0	2676.0	.447-.593	4/0-266.8	2/0 (6/1)-4/0(6/1)	B	7.08	0.50	76AH	0.58
2776.1	2676.1	.609-.743	300-397.5	266.8(18/1)-397.5(18/1)	B	7.08	0.50	76AH	0.58
2720.1	2620.1	.629-.724	336.4 - 397.5	266.8(6/7) - 336.4(30/7)	B	6.87	0.50	20AH	0.52
2720.2	2620.2	.721-.814	397.5-500	336.4(30/7)-477(18/1)	B	6.87	0.50	20AH	0.52
2724.1	2624.1	.793-.926	477-636	397.5(30/7) - 556.5(24/7)	B	7.21	0.50	24AH	0.69
2724.1D	-	.793-.926	477-636	397.5(30/7) - 556.5(24/7)	D	7.21	0.62	24AH	0.69
2727.1	2627.1	.929-1.025	700 - 750	556.5(30/7)-666.6(24/7)	D	7.49	0.62	27AH	1.2
2727.1B	-	.929-1.025	700 - 750	556.5(30/7)-666.6(24/7)	B	7.49	0.50	27AH	1.2
2730.1	2630.1	1.026 - 1.196	795 - 1033.5	715.5(24/7) - 954(54/7)	D	8.84	0.62	30AH	1.6
2730.1B	-	1.026 - 1.196	795 - 1033.5	715.5(24/7) - 954(54/7)	B	8.84	0.50	30AH	1.6
2734.1	2634.1	1.186 - 1.313	954-1272	954(54.7)-1192.5(45/7)	D	9.19	0.62	34AH	1.9
2734.1E	-	1.186 - 1.313	954-1272	954(54.7)-1192.5(45/7)	E	9.81	0.75	34AH	1.9
2736.1	2636.1	1.314 - 1.399	1300-1431	1192.5(54/19) - 1351.5(45/7)	D	9.45	0.62	36AH	2.1
2738.1	2638.1	1.399 - 1.500	1351.5-1590	1351.5(45/7) - 1510.5(45/7)	D	9.69	0.62	38AH	2.3
2738.1E	-	1.399 - 1.500	1351.5-1590	1351.5(45/7) - 1510.5(45/7)	E	9.69	0.75	38AH	2.3
2740.1	2640.1	1.501 - 1.630	1750 - 2000	1510.5(54/19) - 1780(84/19)	D	10.14	0.62	40AH	2.6
2742.1	2642.1	1.630 - 1.681	2000	2034(72/7)	E	11.11	0.75	42AH	3.5
2744.1	2644.1	1.630 - 1.681	2000	2034(72/7)	E	11.61	0.75	44AH	4.0
2744.2	2644.2	1.669 - 1.823	2250 - 2500	2034(72/7) - 2312(76/19)	E	11.61	0.75	44AH	4.0
2748.1	2648.1	1.823 - 1.996	2500 - 2750	2515(76/19)	E	12.64	0.75	48AH	4.6
2748.2	2648.2	1.996 - 2.158	3000-3500	-	E	12.64	0.75	48AH	4.0

Type 3400 Series

Substation 90° terminals are designed for limited space applications as found in substations. Terminals are shorter than conventional terminals which saves space and allows for faster installation. Terminals are installed with standard AFL hex dies. Terminals can be supplied pre-filled if required. Alternate pad sizes available.

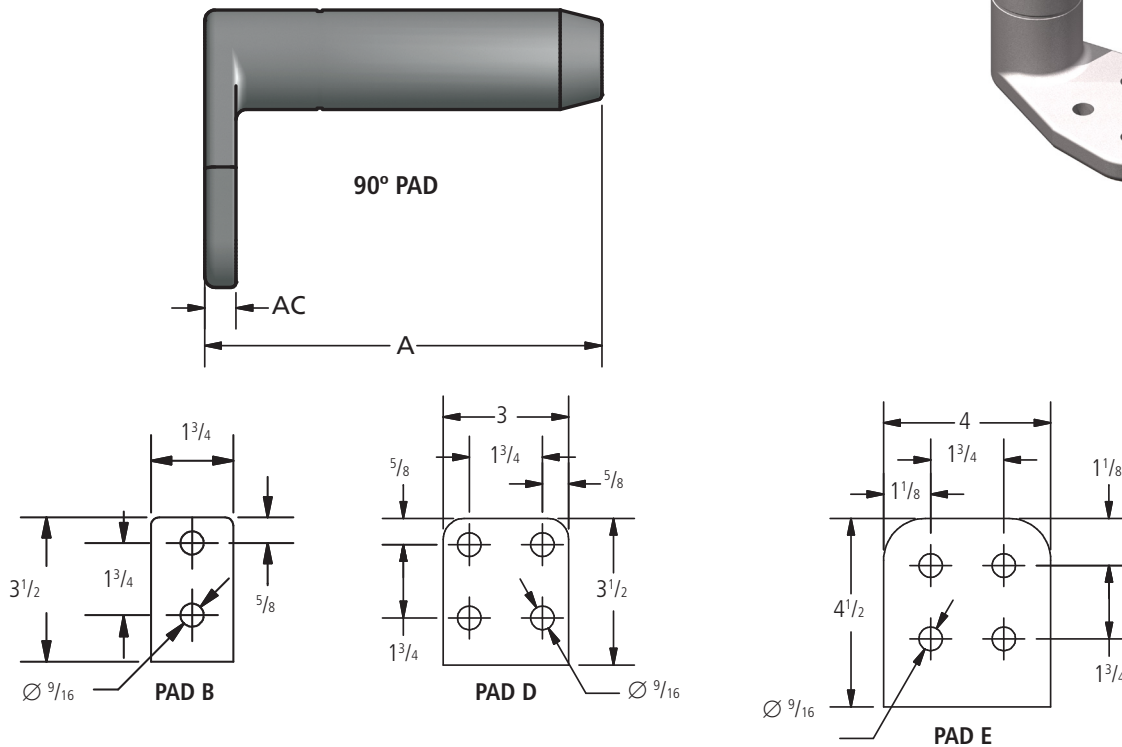

Ordering Information

Catalog Number	Conductor Range			Pad Size	Dimensions (inches)		Die Size	Nominal Weight (lbs)
	Diameter	AAC	ACSR		A	AC		
3420.1	0.629 - 0.724	336.4 - 397.5	266.8 (6/7) - 336.4 (30/7)	B	4.61	0.5	20AH	—
3420.2	0.721 - 0.814	397.5 - 500	336.4 (30/7) - 477 (18/1)	B	4.86	0.5	20AH	—
3424.1	0.793 - 0.928	477 - 636	397.5 (30/7) - 556.5 (24/7)	B	4.86	0.5	24AH	—
3427.1	0.929 - 1.025	700 - 750	556.5 (30/7) - 666.6 (24/7)	D	6.36	0.5	27AH	—
3430.1	1.026 - 1.196	795 - 1033.5	715.5 (24/7) - 954 (54/7)	D	6.03	0.62	30AH	1.3
3434.1	1.186 - 1.313	954 - 1272	954 (54/7) - 1192.5 (45/7)	D	6.44	0.62	34AH	1.6
3436.1	1.314 - 1.399	1300 - 1431	1192.5 (54/19) - 1351.5 (45/7)	D	6.72	0.62	36AH	1.7
3438.1	1.399 - 1.500	1351.5 - 1590	1351.5 (45/7) - 1510.5 (45/7)	D	6.94	0.62	38AH	2.0
3440.1	1.501 - 1.630	1750 - 2000	1510.5 (54/19) - 1780 (84/19)	D	7.38	0.62	40AH	2.2
3442.1	1.630 - 1.681	2000	2034 (72/7)	E	7.81	0.75	42AH	3.0
3444.1	1.630 - 1.681	2000	2034 (72/7)	E	8.22	0.75	44AH	3.4
3444.2	1.669 - 1.823	2250 - 2500	2034 (72/7) - 2312 (76/19)	E	8.22	0.75	44AH	3.3
3448.1	1.823 - 1.996	2500 - 2750	2515 (76/19)	E	9.22	0.75	48AH	4.5
3448.2	1.996 - 2.158	3000 - 3500	—	E	9.22	0.75	48AH	4.0

S5600 Series, S5100 Series Terminal Connectors

The S5600, S5100 Series Terminal Connector is designed for ACSR and AAC conductors. The terminal is fabricated from ACA seamless drawn aluminum.

Notes

Other pads sizes can be custom ordered.

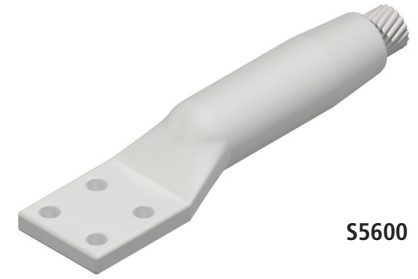

S5600



S5100

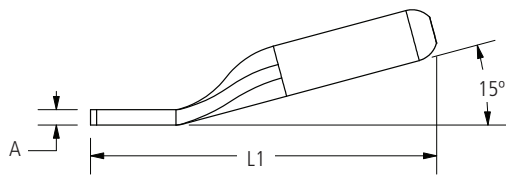

S5100

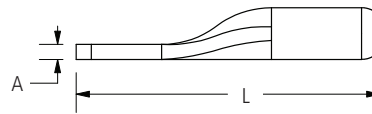

S5600

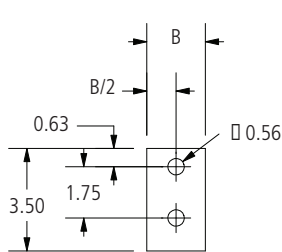

PAD B

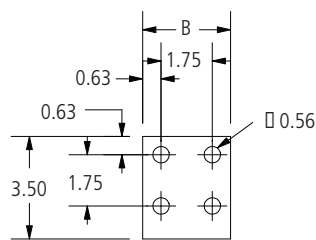

PAD D

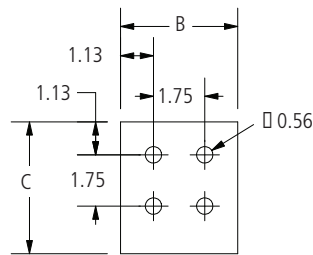

PAD E

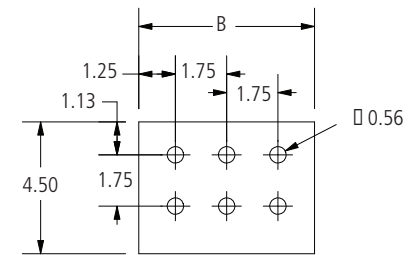

PAD G

Ordering Information

Catalog Number		Conductor					Die Size Aluminum Hex Die	Dimensions in Inches					Pad Size
Straight	15 Degree	ACSR or AAC	Code Word	Size KCMil	Stranding Al/St	Diameter in Inches		A	B	C	L	L1	
S5673.391	S5173.391	AAC	Poppy	1/0	7	0.368	73AH	0.20	1.00	—	7.44	6.44	B
S5673.391D	S5173.391D	AAC	Poppy	1/0	7	0.368	73AH	0.50	3.00	—	7.84	6.44	D
S5674.438	S5174.438	ACSR	Raven	1/0	6/1	0.398	74AH	0.30	1.00	—	7.81	7.31	B
		AAC	Aster	2/0	7	0.414							
S5674.438D	S5174.438D	ACSR	Raven	1/0	6/1	0.398	74AH	0.50	3.00	—	7.84	7.31	D
		AAC	Aster	2/0	7	0.414							
S5674.484	S5174.484	ACSR	Quail	2/0	6/1	0.447	74AH	0.30	1.00	—	7.81	7.31	B
		ACSR	Phlox	3/0	7	0.464							
S5675.547	S5175.547	ACSR	Pigeon	3/0	6/1	0.502	75AH	0.50	1.00	—	8.38	7.00	B
		AAC	Oxlip	4/0	7	0.522							
S5675.547D	S5175.547D	ACSR	Pigeon	3/0	6/1	0.502	75AH	0.50	3.00	—	8.20	6.88	D
		AAC	Oxlip	4/0	7	0.522							
S5675.609	S5175.609	ACSR	Penguin	4/0	6/1	0.563	75AH	0.50	1.00	—	8.38	7.00	B
		AAC	Valerian	250	19	0.575							
		AAC	Laurel	266.8	19	0.593							

S5600 Series, S5100 Series Terminal Connectors (cont.)

Ordering Information

Catalog Number		Conductor					Die Size Aluminum Hex Die	Dimensions in Inches					Pad Size
Straight	15 Degree	ACSR or AAC	Code Word	Size KCMil	Stranding Al/St	Diameter in Inches		A	B	C	L	L1	
S5675.609D	S5175.609D	ACSR	Penguin	4/0	6/1	0.563	75AH	0.50	3.00	—	8.18	7.00	D
		AAC	Valerian	250	19	0.575							
		AAC	Laurel	266.8	19	0.593							
S5676.656	S5176.656	ACSR	Waxwing	266.8	18/1	0.609	76AH	0.60	1.30	—	8.81	9.00	B
		AAC	Peony	300	19	0.629							
S5676.656D	S5176.656D	ACSR	Waxwing	266.8	18/1	0.609	76AH	0.50	3.00	—	7.36	9.00	D
		AAC	Peony	300	19	0.629							
S5676.688	S5176.688	ACSR	Owl	266.8	6/7	0.633	76AH	0.60	1.30	—	8.81	9.00	B
		ACSR	Partridge	266.8	26/7	0.642							
		AAC	Tulip	336.4	19	0.666							
S5676.688D	S5176.688D	ACSR	Owl	266.8	6/7	0.633	76AH	0.50	3.00	—	7.34	9.00	D
		ACSR	Partridge	266.8	26/7	0.642							
		AAC	Tulip	336.4	19	0.666							
S5620.719	S5120.719	AAC	Daffodil	350	19	0.679	20AH	0.50	1.30	—	10.50	8.50	B
S5676.719	S5176.719	ACSR	Ostrich	300	26/7	0.680	76AH	0.50	1.30	—	8.81	9.00	B
		ACSR	Merlin	336.4	18/1	0.684							
S5676.719D	S5176.719D	ACSR	Ostrich	300	26/7	0.680	76AH	0.50	3.00	—	7.33	8.76	D
		ACSR	Merlin	336.4	18/1	0.684							
S5620.781	S5120.781	ACSR	Linnet	336.4	26/7	0.720	20AH	0.50	1.30	—	10.50	8.50	B
		ACSR	Oriole	336.4	30/7	0.741							
		ACSR	Chickadee	397.5	18/1	0.743							
S5620.781D	S5120.781D	ACSR	Linnet	336.4	26/7	0.720	20AH	0.50	3.00	—	7.61	8.50	D
		ACSR	Oriole	336.4	30/7	0.741							
		ACSR	Chickadee	397.5	18/1	0.743							
S5676.781	S5176.781	ACSR	Linnet	336.4	26/7	0.720	76AH	0.50	1.30	—	8.81	9.00	B
		ACSR	Chickadee	397.5	18/1	0.743							
S5676.781D	S5176.781D	ACSR	Linnet	336.4	26/7	0.720	76AH	0.50	3.00	—	7.36	9.00	D
		ACSR	Chickadee	397.5	18/1	0.743							
S5676.750	S5176.750	AAC	Canna	397.5	19	0.724	76AH	0.50	1.30	—	8.81	9.00	B
S5676.750D	S5176.750D	AAC	Canna	397.5	19	0.724	76AH	0.50	3.00	—	8.31	9.00	D
S5620.812	S5120.812	ACSR	Brant	397.5	24/7	0.772	20AH	0.50	1.30	—	10.50	8.50	B
		AAC	Goldentuft	450	19	0.770							
		AAC	Yarrow	450	37	0.772							
		AAC	Cosmos	477	19	0.793							
		AAC	Syringa	477	37	0.795							
S5620.812D	S5120.812D	ACSR	Brant	397.5	24/7	0.772	20AH	0.50	3.00	—	8.47	8.50	D
		AAC	Goldentuft	450	19	0.770							
		AAC	Yarrow	450	37	0.772							
		AAC	Cosmos	477	19	0.793							
		AAC	Syringa	477	37	0.795							
S5620.844	S5120.844	ACSR	Ibis	397.5	26/7	0.783	20AH	0.50	1.30	—	10.50	8.50	B
		ACSR	Lark	397.5	30/7	0.806							
S5624.875	S5124.875	ACSR	Pelican	477	18/1	0.814	24AH	0.60	1.50	—	11.46	10.25	B
		AAC	Cosmos	477	19	0.793							
		AAC	Syringa	477	37	0.795							
		AAC	Zinnia	500	19	0.811							
		AAC	Hyacinth	500	37	0.813							

S5600 Series, S5100 Series Terminal Connectors (cont.)

Ordering Information

Catalog Number		Conductor					Die Size Aluminum Hex Die	Dimensions in Inches					Pad Size
Straight	15 Degree	ACSR or AAC	Code Word	Size KCMil	Stranding Al/St	Diameter in Inches		A	B	C	L	L1	
S5624.875D	S5124.875D	ACSR	Pelican	477	18/1	0.814	24AH	0.50	3.00	—	8.78	10.25	D
		AAC	Cosmos	477	19	0.793							
		AAC	Syringa	477	37	0.795							
		AAC	Zinnia	500	19	0.811							
		AAC	Hyacinth	500	37	0.813							
S5624.938	S5124.938	ACSR	Flicker	477	24/7	0.846	24AH	0.60	1.50	—	11.46	10.25	B
		ACSR	Hawk	477	26/7	0.858							
		ACSR	Hen	477	30/7	0.883							
		ACSR	Osprey	556.5	18/1	0.879							
		AAC	Dahlia	556.5	19	0.856							
		AAC	Mistletoe	556.5	37	0.858							
S5624.938D	S5124.938D	ACSR	Flicker	477	24/7	0.846	24AH	0.50	3.00	—	9.25	10.25	D
		ACSR	Hawk	477	26/7	0.858							
		ACSR	Hen	477	30/7	0.883							
		ACSR	Osprey	556.5	18/1	0.879							
		AAC	Dahlia	556.5	19	0.856							
		AAC	Mistletoe	556.5	37	0.858							
		AAC	Meadowsweet	600	37	0.891							
S5624.969	S5124.969	ACSR	Parakeet	556.5	24/7	0.914	24AH	0.60	1.50	—	11.46	10.25	B
		ACSR	Dove	556.5	26/7	0.927							
		AAC	Orchid	636	37	0.918							
		AAC	Heuchera	650	37	0.928							
S5624.969D	S5124.969D	ACSR	Parakeet	556.5	24/7	0.914	24AH	0.50	3.00	—	9.23	10.25	D
		ACSR	Dove	556.5	26/7	0.927							
		AAC	Orchid	636	37	0.918							
		AAC	Heuchera	650	37	0.928							
S5624.969E	S5124.969E	ACSR	Parakeet	556.5	24/7	0.914	24AH	0.50	4.00	4.00	9.83	10.25	E
		ACSR	Dove	556.5	26/7	0.927							
		AAC	Orchid	636	37	0.918							
		AAC	Heuchera	650	37	0.928							
S5627.100	S5127.100	ACSR	Eagle	556.5	30/7	0.953	27AH	0.40	3.00	—	11.72	10.82	D
		ACSR	Peacock	605	24/7	0.953							
		ACSR	Squab	605	26/7	0.966							
		ACSR	Swift	636	36/1	0.930							
		ACSR	Kingbird	636	18/1	0.940							
		AAC	Flag	700	61	0.964							
S5627.106	S5127.106	ACSR	Teal	605	30/19	0.994	27AH	0.40	3.00	—	11.72	10.82	D
		ACSR	Rook	636	24/7	0.977							
		ACSR	Grosbeak	636	26/7	0.990							
		ACSR	Egret	636	30/19	1.019							
		ACSR	Flamingo	666.6	24/7	1.000							
		AAC	Violet	715.5	37	0.974							
		AAC	Nasturtium	715.5	61	0.975							
		AAC	Petunia	750	37	0.997							
AAC	Cattail	750	61	0.998									

S5600 Series, S5100 Series Terminal Connectors (cont.)

Ordering Information

Catalog Number		Conductor					Die Size Aluminum Hex Die	Dimensions in Inches					Pad Size
Straight	15 Degree	ACSR or AAC	Code Word	Size KCMil	Stranding Al/St	Diameter in Inches		A	B	C	L	L1	
S5627.106E	S5127.106E	ACSR	Teal	605	30/19	0.994	27AH	0.50	4.00	4.00	10.06	10.07	E
		ACSR	Rook	636	24/7	0.977							
		ACSR	Grosbeak	636	26/7	0.990							
		ACSR	Egret	636	30/19	1.019							
		ACSR	Flamingo	666.6	24/7	1.000							
		AAC	Violet	715.5	37	0.974							
		AAC	Nasturtium	715.5	61	0.975							
		AAC	Petunia	750	37	0.997							
S5630.109	S5130.109	AAC	Cattail	750	61	0.998	30AH	0.50	3.00	—	12.50	11.27	D
		ACSR	Stilt	715.5	24/7	1.036							
		ACSR	Starling	715.5	26/7	1.051							
		ACSR	Coot	795	36/1	1.040							
		AAC	Arbutus	795	37	1.026							
		AAC	Lilac	795	61	1.028							
		AAC	—	800	37	1.031							
S5630.109E	S5130.109E	AAC	Heliotrope	800	61	1.031	30AH	0.50	4.00	4.00	9.74	9.67	E
		ACSR	Stilt	715.5	24/7	1.036							
		ACSR	Starling	715.5	26/7	1.051							
		ACSR	Coot	795	36/1	1.040							
		AAC	Arbutus	795	37	1.026							
		AAC	Lilac	795	61	1.028							
S5630.109G	S5130.109G	AAC	—	800	37	1.031	30AH	0.50	6.00	—	13.75	13.75	G
		ACSR	Stilt	715.5	24/7	1.036							
		ACSR	Starling	715.5	26/7	1.051							
		ACSR	Coot	795	36/1	1.040							
		AAC	Arbutus	795	37	1.026							
		AAC	Lilac	795	61	1.028							
S5630.116	S5130.116	AAC	—	800	37	1.031	30AH	0.50	3.00	—	12.50	11.27	D
		ACSR	Redwing	715.5	30/19	1.081							
		ACSR	Tern	795	45/7	1.063							
		ACSR	Condor	795	54/7	1.093							
		ACSR	Drake	795	26/7	1.108							
		ACSR	Cuckoo	795	24/7	1.092							
S5630.116B	S5130.116B	AAC	Snapdragon	900	61	1.094	30AH	0.69	1.75	—	12.50	12.75	B
		ACSR	Redwing	715.5	30/19	1.081							
		ACSR	Tern	795	45/7	1.063							
		ACSR	Condor	795	54/7	1.093							
		ACSR	Drake	795	26/7	1.108							
		ACSR	Cuckoo	795	24/7	1.092							
S5630.116E	S5130.116E	AAC	Snapdragon	900	61	1.094	30AH	1.00	4.00	4.50	13.75	11.22	E
		ACSR	Redwing	715.5	30/19	1.081							
		ACSR	Tern	795	45/7	1.063							
		ACSR	Condor	795	54/7	1.093							
		ACSR	Drake	795	26/7	1.108							
		ACSR	Cuckoo	795	24/7	1.092							

S5600 Series, S5100 Series Terminal Connectors (cont.)

Ordering Information

Catalog Number		Conductor					Die Size Aluminum Hex Die	Dimensions in Inches					Pad Size
Straight	15 Degree	ACSR or AAC	Code Word	Size KCMil	Stranding Al/St	Diameter in Inches		A	B	C	L	L1	
S5630.122	S5130.122	ACSR	Mallard	795	30/19	1.140	30AH	0.40	3.00	—	12.50	11.27	D
		ACSR	Ruddy	900	45/7	1.131							
		ACSR	Canary	900	54/7	1.162							
		ACSR	Catbird	954	36/1	1.140							
		ACSR	Rail	954	45/7	1.165							
		AAC	Magnolia	954	37	1.124							
		AAC	Goldenrod	954	61	1.126							
		AAC	Camellia	1000	61	1.152							
		AAC	Bluebell	1033.5	37	1.170							
S5630.122E	—	ACSR	Mallard	795	30/19	1.140	30AH	0.50	4.00	4.00	10.05	—	E
		ACSR	Ruddy	900	45/7	1.131							
		ACSR	Canary	900	54/7	1.162							
		ACSR	Catbird	954	36/1	1.140							
		ACSR	Rail	954	45/7	1.165							
		AAC	Magnolia	954	37	1.124							
		AAC	Goldenrod	954	61	1.126							
		AAC	Camellia	1000	61	1.152							
		AAC	Bluebell	1033.5	37	1.170							
—	S5130.122E	ACSR	Mallard	795	30/19	1.140	30AH	1.00	4.00	4.50	—	11.27	E
		ACSR	Ruddy	900	45/7	1.131							
		ACSR	Canary	900	54/7	1.162							
		ACSR	Catbird	954	36/1	1.140							
		ACSR	Rail	954	45/7	1.165							
		AAC	Magnolia	954	37	1.124							
		AAC	Goldenrod	954	61	1.126							
		AAC	Camellia	1000	61	1.152							
		AAC	Bluebell	1033.5	37	1.170							
S5630.125	S5130.125	ACSR	Cardinal	954	54/7	1.196	30AH	0.40	3.00	—	12.50	11.27	B
		ACSR	Tanager	1033.5	36/1	1.186							
S5630.125E	—	ACSR	Cardinal	954	54/7	1.196	30AH	0.50	4.00	4.00	10.03	—	E
		ACSR	Tanager	1033.5	36/1	1.186							
—	S5130.125E	ACSR	Cardinal	954	54/7	1.196	30AH	1.00	4.00	4.50	—	11.25	E
		ACSR	Tanager	1033.5	36/1	1.186							
S5634.128	S5134.128	ACSR	Ortolan	1033.5	45/7	1.212	34AH	0.60	3.00	—	12.20	12.44	D
		AAC	Marigold	1113	61	1.216							
S5634.134	S5134.134	ACSR	Curlew	1033.5	54/7	1.244	34AH	0.60	3.00	—	12.20	12.44	D
		ACSR	Bluejay	1113	45/7	1.259							
		AAC	Hawthorn	1192.5	61	1.258							
S5634.134E	S5134.134E	AAC	Narcissus	1272	61	1.300	34AH	1.00	4.00	4.50	11.02	10.83	E
		ACSR	Curlew	1033.5	54/7	1.244							
		ACSR	Bluejay	1113	45/7	1.259							
S5634.138	S5134.138	ACSR	Hawthorn	1192.5	61	1.258	34AH	0.60	3.00	—	12.20	12.44	D
		ACSR	Narcissus	1272	61	1.300							
S5634.138	S5134.138	ACSR	Bunting	1192.5	45/7	1.302	34AH	0.60	3.00	—	12.20	12.44	D
		ACSR	Finch	1113	54/19	1.293							

S5600 Series, S5100 Series Terminal Connectors (cont.)

Ordering Information

Catalog Number		Conductor					Die Size Aluminum Hex Die	Dimensions in Inches					Pad Size
Straight	15 Degree	ACSR or AAC	Code Word	Size KCMil	Stranding Al/St	Diameter in Inches		A	B	C	L	L1	
S5636.144	S5136.144	ACSR	Bittern	1272	45/7	1.345	36AH	0.60	3.00	—	13.76	12.50	D
		ACSR	Grackle	1192.5	54/19	1.333							
		AAC	Columbine	1351	61	1.340							
		AAC	Carnation	1431	61	1.379							
S5636.144E	S5136.144E	ACSR	Bittern	1272	45/7	1.345	36AH	1.00	4.00	4.50	10.85	10.73	E
		ACSR	Grackle	1192.5	54/19	1.333							
		AAC	Columbine	1351	61	1.340							
		AAC	Carnation	1431	61	1.379							
S5636.147	S5136.147	ACSR	Pheasant	1272	54/19	1.382	36AH	0.60	3.00	—	13.76	12.50	D
		ACSR	Dipper	1351.5	45/7	1.386							
		ACSR	—	1500	91	1.412							
		AAC	Gladiolus	1510.5	61	1.187							
S5638.150	S5138.150	ACSR	Martin	1351.5	54/19	1.424	38AH	0.80	3.00	—	13.94	13.69	D
		ACSR	Bobolink	1431	45/7	1.427							
S5638.150E	S5138.150E	ACSR	Martin	1351.5	54/19	1.424	38AH	1.00	4.00	4.50	11.44	13.69	E
		ACSR	Bobolink	1431	45/7	1.427							
S5638.156	S5138.156	ACSR	Plover	1431	54/19	1.465	38AH	0.70	3.00	—	13.94	13.69	D
		ACSR	Nuthatch	1510.5	45/7	1.466							
		AAC	Coreopsis	1590	61	1.250							
		AAC	Dogwood	1590	91	1.454							
S5638.156E	S5138.156E	ACSR	Plover	1431	54/19	1.465	38AH	1.00	4.00	4.50	11.41	14.69	E
		ACSR	Nuthatch	1510.5	45/7	1.466							
		AAC	Coreopsis	1590	61	1.250							
		AAC	Dogwood	1590	91	1.454							
S5640.162	S5140.162	ACSR	Parrot	1510.5	54/19	1.506	40AH	0.70	4.00	4.50	15.58	14.88	E
		ACSR	Lapwing	1590	45/7	1.504							
		ACSR	Falcon	1590	54/19	1.545							
		AAC	Jessamine	1750	61	1.525							
S5640.162E	S5140.162E	ACSR	Parrot	1510.5	54/19	1.506	40AH	1.00	4.00	4.50	11.83	11.92	E
		ACSR	Lapwing	1590	45/7	1.504							
		ACSR	Falcon	1590	54/19	1.545							
		AAC	Jessamine	1750	61	1.525							
S5642.178	S5142.178	ACSR	Chukar	1780	84/19	1.602	42AH	0.66	4.00	4.50	15.91	15.50	E
		ACSR	—	2034	72/7	1.681							
		AAC	Cowslip	2000	91	1.630							
S5644.181	S5144.181	ACSR	Kiwi	2167	72/7	1.737	44AH	0.70	4.00	4.50	17.84	16.00	E
		AAC	Sagebrush	2250	91	1.729							
		AAC	—	2300	61	1.750							
		AAC	—	2300	91	1.750							
S5644.184	S5144.184	ACSR	Bluebird	2156	84/19	1.762	44AH	0.70	4.00	4.50	17.84	16.00	E
S5644.188	S5144.188	ACSR	Thrasher	2312	76/19	1.802	44AH	0.72	4.00	4.50	17.84	16.00	E
		AAC	Lupine	2500	91	1.823							
S5648.197	S5148.197	ACSR	Joree	2515	76/19	1.880	48AH	0.80	4.00	4.50	18.72	17.31	E
		AAC	Bitterroot	2750	91	1.912							

S5600-45 Series, S5800 Series Terminal Connectors

The S5600-45, S5800 Series Terminal Connector is designed for ACSR and AAC conductors. The terminal is fabricated from ACA seamless drawn aluminum.

Notes

Other pads sizes can be custom ordered.



S5600-45



S5800

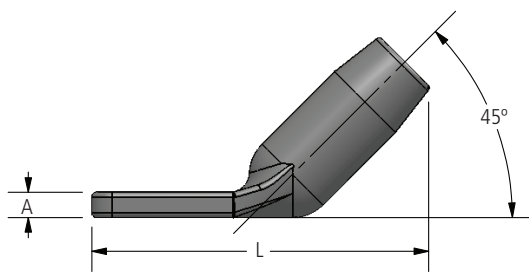

S5600-45

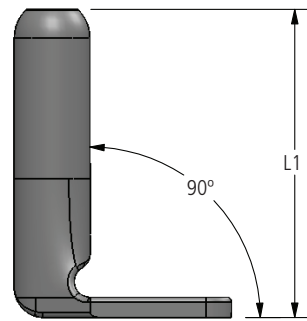

S5800

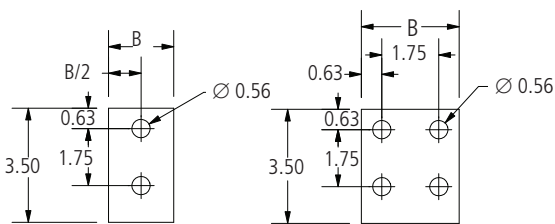

PAD B

PAD D

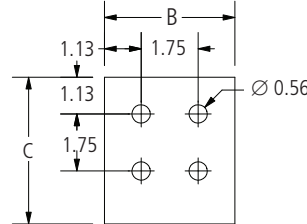

PAD E

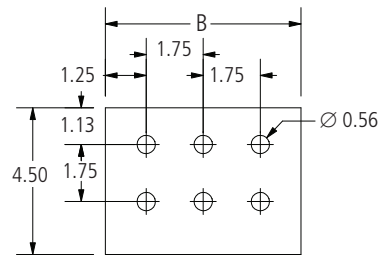

PAD G

Ordering Information

Catalog Number		Conductor					Die Size Aluminum Hex Die	Dimensions in inches					Pad Size
45 Degree	90 Degree	ACSR or AAC	Code Word	Size KCMIL	Stranding Al/St	Dimensions in inches		A	B	C	L	L1	
S5673.391-45	S5873.391	AAC	Poppy	1/0	7	0.368	73AH	0.20	1.00	—	5.04	5.04	B
S5674.438-45	S5874.438	ACSR AAC	Raven Aster	1/0 2/0	6/1 7	0.398 0.414	74AH	0.30	1.00	—	5.28	5.28	B
S5674.484-45	S5874.484	ACSR ACSR	Quail Phlox	2/0 3/0	6/1 7	0.447 0.464	74AH	0.30	1.00	—	5.28	5.28	B
S5675.547-45	S5875.547	ACSR AAC	Pigeon Oxlip	3/0 4/0	6/1 7	0.502 0.522	75AH	0.50	1.00	—	5.71	5.71	B
S5675.547D-45	S5875.547D	ACSR AAC	Pigeon Oxlip	3/0 4/0	6/1 7	0.502 0.522	75AH	0.50	3.00	—	6.89	5.71	D
S5675.609-45	S5875.609	ACSR AAC AAC	Penguin Valerian Laurel	4/0 250 266.8	6/1 19 19	0.563 0.575 0.593	75AH	0.50	1.00	—	5.71	5.71	B
—	S5875.609D	ACSR AAC AAC	Penguin Valerian Laurel	4/0 250 266.8	6/1 19 19	0.563 0.575 0.593	75AH	0.50	3.00	—	—	4.82	D
S5676.656-45	S5876.656	ACSR AAC	Waxwing Peony	266.8 300	18/1 19	0.609 0.629	76AH	0.60	1.30	—	5.35	5.35	B
S5676.688-45	S5876.688	ACSR ACSR AAC	Owl Partridge Tulip	266.8 266.8 336.4	6/7 26/7 19	0.633 0.642 0.666	76AH	0.60	1.30	—	5.35	5.35	B

S5600-45 Series, S5800 Series Terminal Connectors

Ordering Information

Catalog Number		Conductor					Die Size Aluminum Hex Die	Dimensions in inches					Pad Size
45 Degree	90 Degree	ACSR or AAC	Code Word	Size KCMIL	Stranding Al/St	Dimensions in inches		A	B	C	L	L1	
S5676.688D-45	S5876.688D	ACSR	Owl	266.8	6/7	0.633	76AH	0.50	3.00	—	7.02	5.35	D
		ACSR	Partridge	266.8	26/7	0.642							
		AAC	Tulip	336.4	19	0.666							
S5620.719-45	S5820.719	AAC	Daffodil	350	19	0.679	20AH	0.50	1.30	—	6.13	6.13	B
S5676.719-45	S5876.719	ACSR	Ostrich	300	26/7	0.680	76AH	0.50	1.30	—	5.35	5.35	B
		ACSR	Merlin	336.4	18/1	0.684							
S5620.781-45	S5820.781	ACSR	Linnet	336.4	26/7	0.720	20AH	0.50	1.30	—	6.13	6.13	B
		ACSR	Oriole	336.4	30/7	0.741							
		ACSR	Chickadee	397.5	18/1	0.743							
S5620.781D-45	S5820.781D	ACSR	Linnet	336.4	26/7	0.720	20AH	0.50	3.00	—	7.16	5.25	D
		ACSR	Oriole	336.4	30/7	0.741							
		ACSR	Chickadee	397.5	18/1	0.743							
S5676.781-45	S5876.781	ACSR	Linnet	336.4	26/7	0.720	76AH	0.50	1.30	—	5.35	5.35	B
S5676.750-45	S5876.750	ACSR	Chickadee	397.5	18/1	0.743	76AH	0.50	1.30	—	5.35	5.35	B
S5676.750D-45	S5876.750D	AAC	Canna	397.5	19	0.724	76AH	0.50	1.30	—	5.35	5.35	B
S5620.812-45	S5820.812	AAC	Canna	397.5	19	0.724	20AH	0.50	1.30	—	6.13	6.13	B
		ACSR	Brant	397.5	24/7	0.772							
		AAC	Goldentuft	450	19	0.770							
		AAC	Yarrow	450	37	0.772							
		AAC	Cosmos	477	19	0.793							
S5620.812D-45	S5820.812D	AAC	Syringa	477	37	0.795	20AH	0.50	3.00	—	7.16	5.25	D
		ACSR	Brant	397.5	24/7	0.772							
		AAC	Goldentuft	450	19	0.770							
		AAC	Yarrow	450	37	0.772							
		AAC	Cosmos	477	19	0.793							
S5620.844-45	S5820.844	ACSR	Syringa	477	37	0.795	20AH	0.50	1.30	—	6.13	6.13	B
		ACSR	Ibis	397.5	26/7	0.783							
S5624.875-45	S5824.875	ACSR	Lark	397.5	30/7	0.806	24AH	0.60	1.50	—	7.58	7.58	B
		ACSR	Pelican	477	18/1	0.814							
		AAC	Cosmos	477	19	0.793							
		AAC	Syringa	477	37	0.795							
		AAC	Zinnia	500	19	0.811							
S5624.875D-45	S5824.875D	AAC	Hyacinth	500	37	0.813	24AH	0.50	3.00	—	8.27	6.81	D
		ACSR	Pelican	477	18/1	0.814							
		AAC	Cosmos	477	19	0.793							
		AAC	Syringa	477	37	0.795							
S5624.938-45	S5824.938	AAC	Zinnia	500	19	0.811	24AH	0.60	1.50	—	7.58	7.58	B
		AAC	Hyacinth	500	37	0.813							
		ACSR	Flicker	477	24/7	0.846							
		ACSR	Hawk	477	26/7	0.858							
		ACSR	Hen	477	30/7	0.883							
		ACSR	Osprey	556.5	18/1	0.879							
		AAC	Dahlia	556.5	19	0.856							
S5624.938D-45	S5824.938D	AAC	Mistletoe	556.5	37	0.858	24AH	0.50	3.00	—	8.47	5.90	D
		AAC	Meadowsweet	600	37	0.891							
		ACSR	Flicker	477	24/7	0.846							
		ACSR	Hawk	477	26/7	0.858							
		ACSR	Hen	477	30/7	0.883							
		ACSR	Osprey	556.5	18/1	0.879							
		AAC	Dahlia	556.5	19	0.856							
S5624.969-45	S5824.969	AAC	Mistletoe	556.5	37	0.858	24AH	0.60	1.50	—	7.58	7.58	B
		AAC	Meadowsweet	600	37	0.891							
		ACSR	Parakeet	556.5	24/7	0.914							
		ACSR	Dove	556.5	26/7	0.927							
S5624.969D-45	S5824.969D	AAC	Orchid	636	37	0.918	24AH	0.50	3.00	—	8.83	5.34	D
		AAC	Heuchera	650	37	0.928							
		ACSR	Parakeet	556.5	24/7	0.914							
		ACSR	Dove	556.5	26/7	0.927							

S5600-45 Series, S5800 Series Terminal Connectors

Ordering Information

CATALOG NUMBER		CONDUCTOR					DIE SIZE ALUMINUM HEX DIE	DIMENSIONS (inches)					PAD SIZE
45 DEGREE	90 DEGREE	ACSR OR AAC	CODE WORD	SIZE KCMil	STRANDING Al/St	DIAMETER IN INCHES		A	B	C	L	L1	
S5627.100-45	S5827.100	ACSR	Eagle	556.5	30/7	0.953	27AH	0.40	3.00	—	7.35	7.35	D
		ACSR	Peacock	605	24/7	0.953							
		ACSR	Squab	605	26/7	0.966							
		ACSR	Swift	636	36/1	0.930							
		ACSR	Kingbird	636	18/1	0.940							
		AAC	Flag	700	61	0.964							
		AAC	Teal	605	30/19	0.994							
S5627.106-45	S5827.106	ACSR	Rook	636	24/7	0.977	27AH	0.40	3.00	—	7.35	7.35	D
		ACSR	Grosbeak	636	26/7	0.990							
		ACSR	Egret	636	30/19	1.019							
		ACSR	Flamingo	666.6	24/7	1.000							
		AAC	Violet	715.5	37	0.974							
		AAC	Nasturtium	715.5	61	0.975							
		AAC	Petunia	750	37	0.997							
		AAC	Cattail	750	61	0.998							
		AAC	Stilt	715.5	24/7	1.036							
S5630.109-45	S5830.109	ACSR	Starling	715.5	26/7	1.051	30AH	0.50	3.00	—	10.38	7.63	D
		ACSR	Coot	795	36/1	1.040							
		AAC	Arbutus	795	37	1.026							
		AAC	Lilac	795	61	1.028							
		AAC	—	800	37	1.031							
		AAC	Heliotrope	800	61	1.031							
S5630.109E-45	—	ACSR	Stilt	715.5	24/7	1.036	30AH	1.00	4.00	4.50	9.75	—	E
		ACSR	Starling	715.5	26/7	1.051							
		ACSR	Coot	795	36/1	1.040							
		AAC	Arbutus	795	37	1.026							
		AAC	Lilac	795	61	1.028							
		AAC	—	800	37	1.031							
—	S5830.109E	ACSR	Stilt	715.5	24/7	1.036	30AH	0.50	4.00	4.50	—	7.63	E
		ACSR	Starling	715.5	26/7	1.051							
		ACSR	Coot	795	36/1	1.040							
		AAC	Arbutus	795	37	1.026							
		AAC	Lilac	795	61	1.028							
		AAC	—	800	37	1.031							
S5630.109G-45	S5830.109G	ACSR	Heliotrope	800	61	1.031	30AH	0.50	6.00	—	7.63	7.63	G
		ACSR	Stilt	715.5	24/7	1.036							
		ACSR	Starling	715.5	26/7	1.051							
		ACSR	Coot	795	36/1	1.040							
		AAC	Arbutus	795	37	1.026							
		AAC	Lilac	795	61	1.028							
S5630.116-45	S5830.116	ACSR	—	800	37	1.031	30AH	0.50	3.00	—	10.38	7.63	D
		ACSR	Heliotrope	800	61	1.031							
		ACSR	Redwing	715.5	30/19	1.081							
		ACSR	Tern	795	45/7	1.063							
		ACSR	Condor	795	54/7	1.093							
		ACSR	Drake	795	26/7	1.108							
S5630.116E-45	—	ACSR	Cuckoo	795	24/7	1.092	30AH	1.00	4.50	4.50	9.75	—	E
		ACSR	Cuckoo	795	24/7	1.092							
		ACSR	Cuckoo	795	24/7	1.092							
		AAC	Snapdragon	900	61	1.094							
		ACSR	Redwing	715.5	30/19	1.081							
		ACSR	Tern	795	45/7	1.063							
—	S5830.116E	ACSR	Condor	795	54/7	1.093	30AH	0.50	4.00	4.00	—	7.63	E
		ACSR	Drake	795	26/7	1.108							
		ACSR	Cuckoo	795	24/7	1.092							
		AAC	Snapdragon	900	61	1.094							
		ACSR	Redwing	715.5	30/19	1.081							
		ACSR	Tern	795	45/7	1.063							

S5600-45 Series, S5800 Series Terminal Connectors

Ordering Information

CATALOG NUMBER		CONDUCTOR					DIE SIZE ALUMINUM HEX DIE	DIMENSIONS (inches)					PAD SIZE
45 DEGREE	90 DEGREE	ACSR OR AAC	CODE WORD	SIZE KCMil	STRANDING Al/St	DIAMETER IN INCHES		A	B	C	L	L1	
S5630.122-45	S5830.122	ACSR	Mallard	795	30/19	1.140	30AH	0.40	3.00	—	10.38	7.63	D
		ACSR	Ruddy	900	45/7	1.131							
		ACSR	Canary	900	54/7	1.162							
		ACSR	Catbird	954	36/1	1.140							
		ACSR	Rail	954	45/7	1.165							
		AAC	Magnolia	954	37	1.124							
		AAC	Goldenrod	954	61	1.126							
		AAC	Camellia	1000	61	1.152							
		AAC	Bluebell	1033.5	37	1.170							
S5630.125-45	S5830.125	ACSR	Cardinal	954	54/7	1.196	30AH	0.40	3.00	—	10.38	7.63	D
		ACSR	Tanager	1033.5	36/1	1.186							
		ACSR	Cardinal	954	54/7	1.196							
—	S5830.125E	ACSR	Tanager	1033.5	36/1	1.186	30AH	0.50	4.00	4.00	—	7.63	E
S5634.128-45	S5834.128	ACSR	Ortolan	1033.5	45/7	1.212	34AH	0.60	3.00	—	10.50	8.20	D
		AAC	Marigold	1113	61	1.216							
S5634.134-45	S5834.134	ACSR	Curlew	1033.5	54/7	1.244	34AH	0.60	3.00	—	10.50	8.20	D
		ACSR	Bluejay	1113	45/7	1.259							
		AAC	Hawthorn	1192.5	61	1.258							
		AAC	Narcissus	1272	61	1.300							
S5634.134E-45	—	ACSR	Curlew	1033.5	54/7	1.244	34AH	1.00	4.00	4.50	10.08	—	E
		ACSR	Bluejay	1113	45/7	1.259							
		AAC	Hawthorn	1192.5	61	1.258							
		AAC	Narcissus	1272	61	1.300							
—	S5834.134E	ACSR	Curlew	1033.5	54/7	1.244	34AH	1.00	4.00	4.00	—	10.08	E
		ACSR	Bluejay	1113	45/7	1.259							
		AAC	Hawthorn	1192.5	61	1.258							
S5634.138-45	S5834.138	ACSR	Bunting	1192.5	45/7	1.302	34AH	0.60	3.00	—	10.50	8.20	D
		ACSR	Finch	1113	54/19	1.293							
S5636.144-45	S5836.144	ACSR	Bittern	1272	45/7	1.345	36AH	0.60	3.00	—	10.70	8.23	D
		ACSR	Grackle	1192.5	54/19	1.333							
		AAC	Columbine	1351	61	1.340							
		AAC	Carnation	1431	61	1.379							
S5636.144E-45	S5836.144E	ACSR	Bittern	1272	45/7	1.345	36AH	1.00	4.00	3.63	10.70	10.70	E
		ACSR	Grackle	1192.5	54/19	1.333							
		AAC	Columbine	1351	61	1.340							
		AAC	Carnation	1431	61	1.379							
S5636.147-45	S5836.147	ACSR	Pheasant	1272	54/19	1.382	36AH	0.60	3.00	—	10.70	8.23	D
		ACSR	Dipper	1351.5	45/7	1.386							
		ACSR	—	1500	91	1.412							
S5638.150-45	S5838.150	AAC	Gladiolus	1510.5	61	1.187	38AH	0.80	3.00	—	10.86	8.85	D
		ACSR	Martin	1351.5	54/19	1.424							
S5638.150E-45	S5838.150E	ACSR	Bobolink	1431	45/7	1.427	38AH	0.50	4.00	4.00	10.86	8.69	E
		ACSR	Martin	1351.5	54/19	1.424							
S5638.156-45	S5838.156	ACSR	Bobolink	1431	45/7	1.427	38AH	0.70	3.00	—	10.86	8.85	D
		ACSR	Plover	1431	54/19	1.465							
		ACSR	Nuthatch	1510.5	45/7	1.466							
		AAC	Coreopsis	1590	61	1.250							
S5638.156E-45	—	AAC	Dogwood	1590	91	1.454	38AH	1.00	4.50	4.50	10.60	—	E
		ACSR	Plover	1431	54/19	1.465							
		ACSR	Nuthatch	1510.5	45/7	1.466							
		AAC	Coreopsis	1590	61	1.250							
—	S5838.156E	AAC	Dogwood	1590	91	1.454	38AH	0.50	4.00	4.00	—	8.69	E
		ACSR	Plover	1431	54/19	1.465							
		ACSR	Nuthatch	1510.5	45/7	1.466							
		AAC	Coreopsis	1590	61	1.250							
S5640.162-45	S5840.162	ACSR	Dogwood	1590	91	1.454	40AH	0.70	3.00	—	9.95	9.95	D
		ACSR	Parrot	1510.5	54/19	1.506							
		ACSR	Lapwing	1590	45/7	1.504							
		ACSR	Falcon	1590	54/19	1.545							
S5640.162E-45	S5840.162E	AAC	Jessamine	1750	61	1.525	40AH	1.00	4.00	4.50	12.18	7.52	E
		ACSR	Parrot	1510.5	54/19	1.506							
		ACSR	Lapwing	1590	45/7	1.504							
		ACSR	Falcon	1590	54/19	1.545							
		AAC	Jessamine	1750	61	1.525							

S5600-45 Series, S5800 Series Terminal Connectors

Ordering Information

CATALOG NUMBER		CONDUCTOR					DIE SIZE ALUMINUM HEX DIE	DIMENSIONS (inches)					PAD SIZE
45 DEGREE	90 DEGREE	ACSR OR AAC	CODE WORD	SIZE KCMil	STRANDING Al/St	DIAMETER IN INCHES		A	B	C	L	L1	
S5642.178-45	S5842.178	ACSR	Chukar	1780	84/19	1.602	42AH	0.70	4.00	4.50	12.37	10.28	E
		ACSR	—	2034	72/7	1.681							
		AAC	Cowslip	2000	91	1.630							
S5644.181-45	S5844.181	ACSR	Kiwi	2167	72/7	1.737	44AH	0.70	4.00	4.50	12.68	10.34	E
		AAC	Sagebrush	2250	91	1.729							
		AAC	—	2300	61	1.750							
		AAC	—	2300	91	1.750							
S5644.184-45	S5844.184	ACSR	Bluebird	2156	84/19	1.762	44AH	0.70	4.00	4.50	12.68	10.34	E
S5644.188-45	S5844.188	ACSR	Thrasher	2312	76/19	1.802	44AH	0.70	4.00	4.50	12.68	10.34	E
		AAC	Lupine	2500	91	1.823							
S5648.197-45	S5848.197	ACSR	Joree	2515	76/19	1.880	48AH	0.80	4.00	4.50	13.38	11.35	E
		AAC	Bitterroot	2750	91	1.912							