



Opti-Guard Splice Enclosure

The Opti-Guard Splice Enclosure from AFL offers an impressive spectrum of features which makes it the best selection for your splice protection needs. Its unique and flexible design was created with the "real-world" technician in mind. The Opti-Guard combines optimized system performance with unparalleled ease of use. It is resistant to water, ultraviolet rays, temperature and ballistics. Opti-Guard installs easily without messy tapes or adhesives. It provides the flexibility needed to handle the most demanding installation scenarios.

Features

- Accommodates up to 672 single fusion splices
- Craft friendly design requires no specialized tools to install and minimizes required training
- Easy to maintain and re-enter; no re-entry kit required
- Unit is lightweight and mounts to many types of structures
- May be bolted or banded; no special adapters needed
- Specially designed non-metallic housing
- Environmentally sealed to protect fibers
- Accepts up to six individual cables
- Accommodates most cable types in most environments
- Versatile cable tie-off system resists up to 100 pounds of tension per cable

Ordering Information

DESCRIPTION	MODEL	AFL NO.
Supplied without Splice Trays or Cable Connectors. These items ordered separately	Opti-Guard Splice Enclosure	OG03
Capacity of up to 72 single fusion splices per tray	Opti-Guard Splice Tray	OGST01-72
Capacity of up to 96 single fusion splices per tray	Opti-Guard Splice Tray	OGST01-96
60 mm, Fujikura FP3 (standard) 40 mm, Fujikura FP3-40 (special applications only) <i>Sold in packs of ten (not included with splice trays)</i>	Splice Protection Sleeves	SPS60 SPS40
Ballistic shield for Opti-Guard Splice Enclosure	Opti-Guard Bullet Guard	OGBGS-01
Order one kit for each stainless steel tube	Opti-Guard Fiber Routing Kit	OGFK01
Used for Optical Ground Wire	Connector Kit	SLCK, SCK, APCK
Used for All-Dielectric Self-Supporting (ADSS) Cable and Loose Tube Cable	Connector Kit	BCK
Used to store extra length of optical ground wire cable	External Coil Bracket	CB-44-3AL

NOTE: Refer to page on Connector Kit for AFL number set-up.

continued
→

Opti-Guard Splice Enclosure

Exploded View

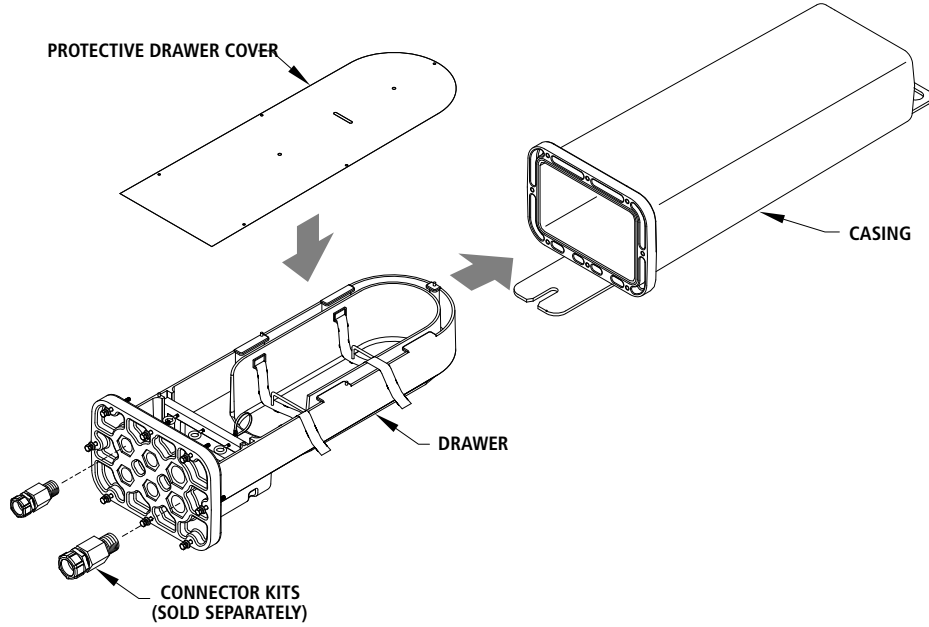

Mounting Details and Options

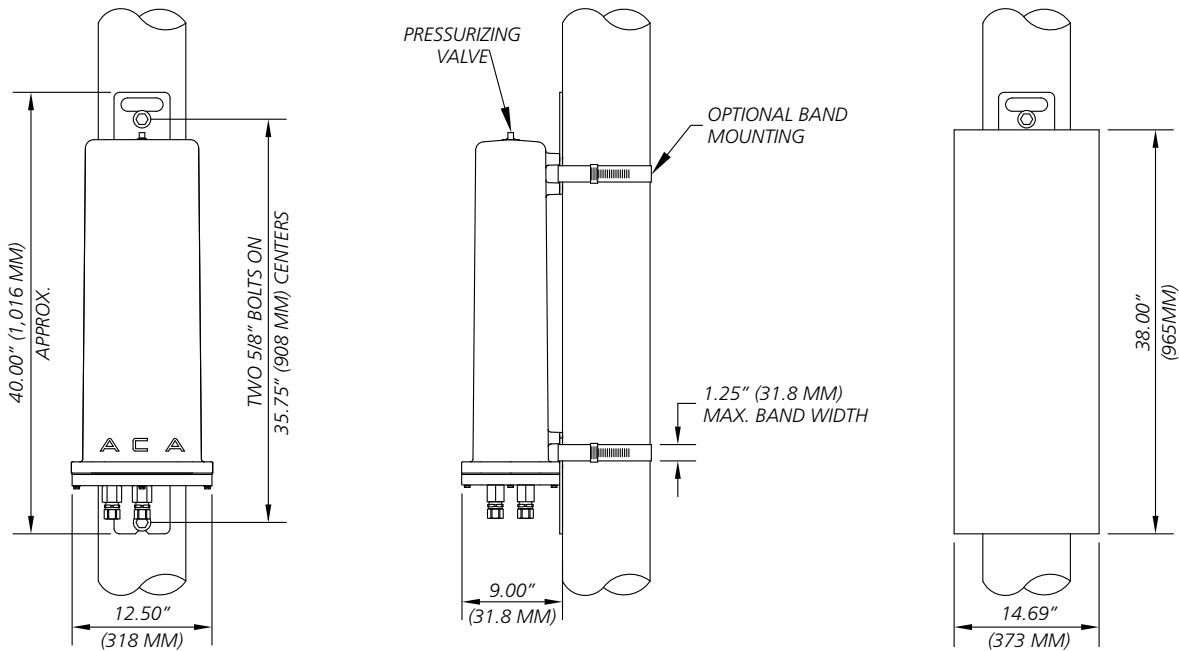

continued
→

Connector Kits for Opti-Guard and SB01 Splice Enclosures—OPGW Cable

Connector Kit: Optical Ground Wire



Optical Ground Wire Connector Kit

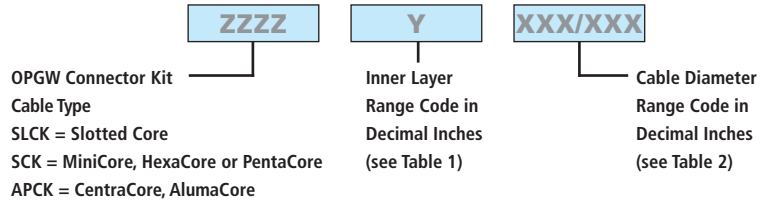

Ordering Example: For 0.571" diameter SX-67/49/571, which has a layer 1 total diameter of 0.358", the AFL number is SCKB569/583.

Table 1 – Inner Layer Range Codes

RANGE CODE	 SLOTTED CORE DIAMETER	 MINICORE, HEXACORE OR PENTACORE LAYER 1 DIAMETER	 CENTRACORE OR ALUMACORE PIPE DIAMETER
A	0.185 - 0.227	0.000 - 0.230	0.185 - 0.227
B	0.228 - 0.264	0.231 - 0.500	0.228 - 0.264
C	0.265 - 0.300	0.501 - 0.636	0.265 - 0.300
D	0.301 - 0.374	—	0.301 - 0.374
E	0.375 - 0.479	—	0.375 - 0.479
F	0.480 - 0.550	—	0.480 - 0.550
G	0.551 - 0.630	—	0.551 - 0.630
H	0.631 - 0.700	—	0.631 - 0.700

Table 2 – Cable Diameter Range Codes

RANGE CODE	CABLE DIAMETER RANGE	
	MIN.	MAX.
225/240	0.225	0.240
241/255	0.241	0.255
256/271	0.256	0.271
272/286	0.272	0.286
287/302	0.287	0.302
303/318	0.303	0.318
319/333	0.319	0.333
334/349	0.334	0.349
350/365	0.350	0.365
366/380	0.366	0.380
381/396	0.381	0.396
397/412	0.397	0.412
413/427	0.413	0.427
428/443	0.428	0.443
444/459	0.444	0.459
460/474	0.460	0.474
475/490	0.475	0.490

RANGE CODE	CABLE DIAMETER RANGE	
	MIN.	MAX.
491/506	0.491	0.506
507/521	0.507	0.521
522/537	0.522	0.537
538/553	0.538	0.553
554/568	0.554	0.568
569/583	0.569	0.583
584/599	0.584	0.599
600/615	0.600	0.615
616/630	0.616	0.630
631/646	0.631	0.646
647/662	0.647	0.662
663/677	0.663	0.677
678/693	0.678	0.693
694/708	0.694	0.708
709/727	0.709	0.727
728/740	0.728	0.740

continued →

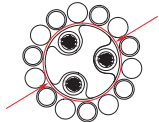
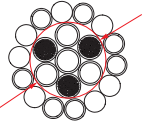
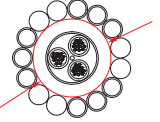
Connector Kits for Opti-Guard and SB01 Splice Enclosures— Black Jacket Cable

Connector Kit: All-Dielectric Self-Supporting Fiber Optic Cable

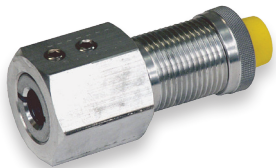

All-Dielectric Self-Supporting Connector Kit

BCK

Black Jacket Cable
Connector Kit

XXX/XXX

Range Code in
Decimal Inches
(see Table 1 below)

F

Blank = No Additional Connector
Assembly Required
F = 1" Flex Conduit Connector Required

Ordering Example: For 0.528" diameter ADSS, the AFL number is BCK522/537.

Connector Kit: Loose Tube Fiber Optic Cable

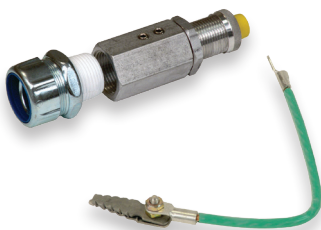

Armored Loose Tube Connector Kit

BCK

Black Jacket Cable
Connector Kit

XXX/XXX

Range Code in
Decimal Inches
(see Table 1 below)

B

Options
Blank = No Additional Connector
Assembly Required
F = 1" Flexible Conduit Connector Required
A = Armor Ground Assembly Required
B = Armor Ground Assembly and 1" Flexible
Conduit Connector Required

Ordering Example: For 0.510" armored loose tube (duct) cable with flexible conduit and armor ground connections, the AFL number is BCK507/521B.

Table 1

RANGE CODE	CABLE DIAMETER RANGE	
	MIN.	MAX.
225/240	0.225	0.240
241/255	0.241	0.255
256/271	0.256	0.271
272/286	0.272	0.286
287/302	0.287	0.302
303/318	0.303	0.318
319/333	0.319	0.333
334/349	0.334	0.349
350/365	0.350	0.365
366/380	0.366	0.380
381/396	0.381	0.396
397/412	0.397	0.412
413/427	0.413	0.427
428/443	0.428	0.443
444/459	0.444	0.459
460/474	0.460	0.474
475/490	0.475	0.490

RANGE CODE	CABLE DIAMETER RANGE	
	MIN.	MAX.
491/506	0.491	0.506
507/521	0.507	0.521
522/537	0.522	0.537
538/553	0.538	0.553
554/568	0.554	0.568
569/583	0.569	0.583
584/599	0.584	0.599
600/615	0.600	0.615
616/630	0.616	0.630
631/646	0.631	0.646
647/662	0.647	0.662
663/677	0.663	0.677
678/693	0.678	0.693
694/708	0.694	0.708
709/727	0.709	0.727
728/740	0.728	0.740

continued →

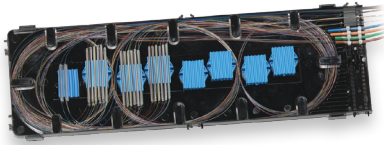

Opti-Guard Splice Tray

Opti-Guard Splice Tray

The Opti-Guard Splice Tray is specifically designed to be used with the Opti-Guard Splice Enclosure.

Features

- 72 or 96 fiber splice capacity
- Manifolds are easily removed for lower fiber counts
- Clear cover for easy fiber identification

Ordering Information

MODEL	AFL NO.
Opti-Guard Splice Tray (72 fiber)	OGST01-72
Opti-Guard Splice Tray (96 fiber)	OGST01-96
60 mm Splice Protection Sleeve	SPS60
40 mm Splice Protection Sleeve	SPS40



Opti-Guard Bullet Guard

Opti-Guard Bullet Guard

The Opti-Guard Bullet Guard is designed to supplement the ballistic resistance of the Opti-Guard Splice Enclosure.

Features

- Can be retrofitted onto existing installations without disturbing cables
- Only a standard flat-blade screwdriver required for installation

Ordering Information

MODEL	AFL NO.
Opti-Guard Bullet Guard	OGBGS-01



Opti-Guard Fiber Routing Kit

Opti-Guard Fiber Routing Kit

The Opti-Guard Fiber Routing Kit provides all of the materials to properly route fibers from a stainless steel tube to the OGST01-72 splice tray inside the Opti-Guard splice enclosure.

Features

- Primary transition tubing leads fiber from stainless steel tube to splice tray
- Heat Shrink tubing guides fibers as they exit the stainless steel tube
- Cable ties provided to secure tubing to the tray and the end of the stainless steel tube

Ordering Information

MODEL	AFL NO.
Opti-Guard Fiber Routing Kit	OGFK01

NOTE: Order one kit for each stainless steel tube.



SB01

SB01 Splice Enclosure

AFL's splice enclosure provides protection from all types of elements. From weather to bullets, the iron and steel construction requires no additional protective covering. Furnished with four plugged cable ports (2 aluminum and 2 plastic) for either All-Dielectric Self-Supporting (ADSS) or Optical Ground Wire (OPGW) cables, the splice enclosure can be pre-mounted to a structure before completion of the splicing phase.

With an internal capacity to store approximately 25 feet of buffer tube, the closure is more cost-effective, eliminating the need for an external coil storage bracket (with exception to stainless steel tube optical ground wire designs). The 72-fiber circular fiber tray, constructed of high impact-resistant Lexan®, enables management of up to 144 fibers. The tray's black base and clear lid enable easy accessibility.

Ideal for electric utilities and optical cable installers, the splice enclosure is versatile and cost-effective for new and existing installations.

Features

- Up to 144-fiber splice capacity, depending on cable design
- Customizable kit with no special re-entry kits required
- Splice tray constructed of high impact-resistant Lexan®
- Manufactured of iron and steel; bullet-resistant
- Pre-mountable enabling easy re-entry and access
- Unique new gasket with top-center radius eliminates the need for RTV sealant
- New C11508-1 gasket can be retrofitted to existing splice closures

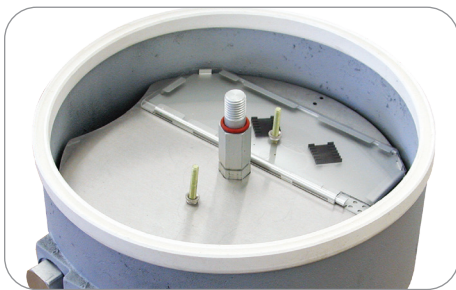

SB01 with 12 splice capacity tray



SB01 with 72 splice capacity tray



Top view of new SB01 gasket (AFL No. C11508-1)

Ordering Instructions – Step 1

DESCRIPTION	AFL NO.
Splice Enclosure including one splice tray for 12 single fused fiber capacity, sealant, organizer tray for additional trays.	SB01
Splice Enclosure including one splice tray for 72 single fused fiber capacity. Protection sleeves not included.	SB01-72
Splice Enclosure including two splice trays for 72 single fused fiber capacity, a total of 144 splices. Protection sleeves not included.	SB01-144

Cable connector kits required to complete installation are sold separately. Refer to "Ordering Instructions" Steps 2 and 3 on the following pages to complete your order.

Ordering Instructions – Step 2

CONNECTOR KIT	APPLICATION
SLCK, SCK, APCK	Optical Ground Wire
BCK	All-Dielectric Self-Supporting (ADSS) Fiber Optic Cable Loose Tube Fiber Optic Cable

Refer to page on connector kits for AFL number set-up.

continued
→

SB01 Splice Enclosure (cont.)

Specifications

PARAMETER	VALUE
Maximum Tray Capacity (depending on tray type)	4 ST1 Trays or 2 ST72 Trays
Maximum Fiber Count (depending on tray type)	48 with ST1; 144 with (2) ST72
Weight	52 lbs. (23.57 kg)
Diameter	14.56 in. (370 mm)
Height (with cover)	5.25 in (133.35 mm)
Mounting Distance (hole to hole)	17.88 in (454.15 mm)

Dimensions

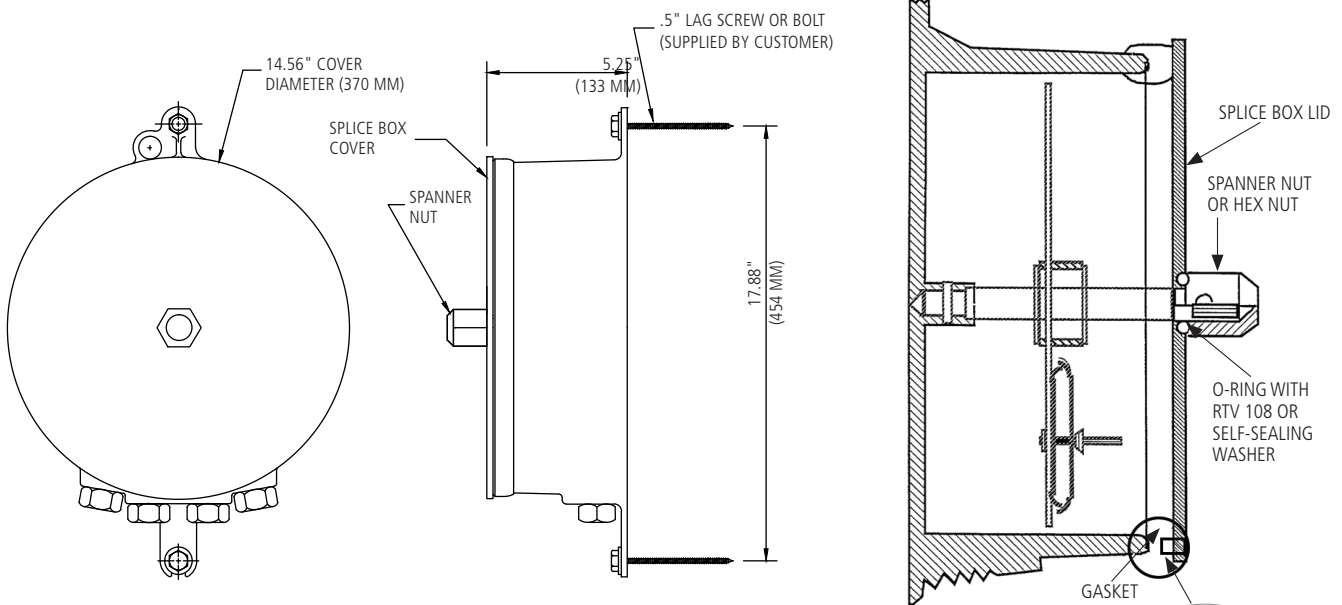

NOTE: Banding and steel tower adapters are available in lieu of bolts.

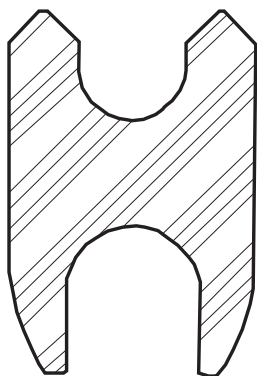

Old Gasket Design

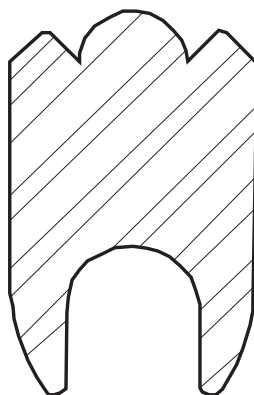

New Gasket Design
(AFL No. C11508-1)

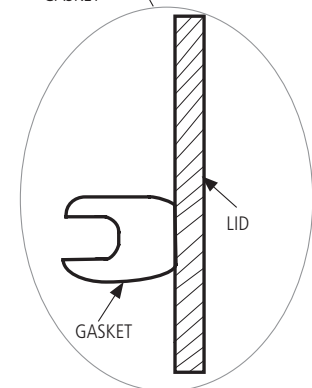

continued →

Connector Kits for Opti-Guard and SB01 Splice Enclosures—OPGW Cable

Connector Kit: Optical Ground Wire

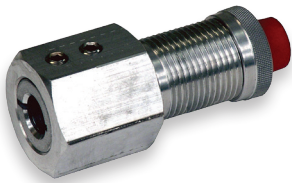

Optical Ground Wire Connector Kit

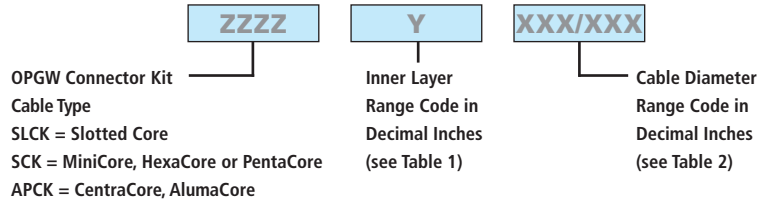

Ordering Example: For 0.571" diameter SX-67/49/571, which has a layer 1 total diameter of 0.358", the AFL number is SCKB569/583.

Table 1 – Inner Layer Range Codes

RANGE CODE	 SLOTTED CORE DIAMETER	 MINICORE, HEXACORE OR PENTACORE LAYER 1 DIAMETER	 CENTRACORE OR ALUMACORE PIPE DIAMETER
A	0.185 - 0.227	0.000 - 0.230	0.185 - 0.227
B	0.228 - 0.264	0.231 - 0.500	0.228 - 0.264
C	0.265 - 0.300	0.501 - 0.636	0.265 - 0.300
D	0.301 - 0.374	—	0.301 - 0.374
E	0.375 - 0.479	—	0.375 - 0.479
F	0.480 - 0.550	—	0.480 - 0.550
G	0.551 - 0.630	—	0.551 - 0.630
H	0.631 - 0.700	—	0.631 - 0.700

Table 2 – Cable Diameter Range Codes

RANGE CODE	CABLE DIAMETER RANGE	
	MIN.	MAX.
225/240	0.225	0.240
241/255	0.241	0.255
256/271	0.256	0.271
272/286	0.272	0.286
287/302	0.287	0.302
303/318	0.303	0.318
319/333	0.319	0.333
334/349	0.334	0.349
350/365	0.350	0.365
366/380	0.366	0.380
381/396	0.381	0.396
397/412	0.397	0.412
413/427	0.413	0.427
428/443	0.428	0.443
444/459	0.444	0.459
460/474	0.460	0.474
475/490	0.475	0.490

RANGE CODE	CABLE DIAMETER RANGE	
	MIN.	MAX.
491/506	0.491	0.506
507/521	0.507	0.521
522/537	0.522	0.537
538/553	0.538	0.553
554/568	0.554	0.568
569/583	0.569	0.583
584/599	0.584	0.599
600/615	0.600	0.615
616/630	0.616	0.630
631/646	0.631	0.646
647/662	0.647	0.662
663/677	0.663	0.677
678/693	0.678	0.693
694/708	0.694	0.708
709/727	0.709	0.727
728/740	0.728	0.740

continued →

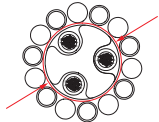
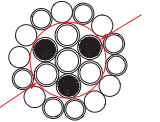
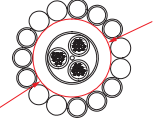
Connector Kits for Opti-Guard and SB01 Splice Enclosures— Black Jacket Cable

Connector Kit: All-Dielectric Self-Supporting Fiber Optic Cable



All-Dielectric Self-Supporting Connector Kit

BCK

Black Jacket Cable
Connector Kit

XXX/XXX

Range Code in
Decimal Inches
(see Table 1 below)

F

Blank = No Additional Connector
Assembly Required
F = 1" Flex Conduit Connector Required

Ordering Example: For 0.528" diameter ADSS, the AFL number is BCK522/537.

Connector Kit: Loose Tube Fiber Optic Cable

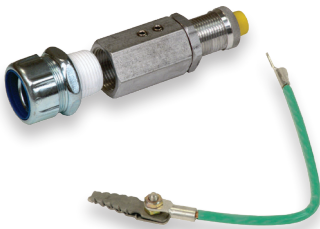

Armored Loose Tube Connector Kit

BCK

Black Jacket Cable
Connector Kit

XXX/XXX

Range Code in
Decimal Inches
(see Table 1 below)

B

Options
Blank = No Additional Connector
Assembly Required
F = 1" Flexible Conduit Connector Required
A = Armor Ground Assembly Required
B = Armor Ground Assembly and 1" Flexible
Conduit Connector Required

Ordering Example: For 0.510" armored loose tube (duct) cable with flexible conduit and armor ground connections, the AFL number is BCK507/521B.

Table 1

RANGE CODE	CABLE DIAMETER RANGE	
	MIN.	MAX.
225/240	0.225	0.240
241/255	0.241	0.255
256/271	0.256	0.271
272/286	0.272	0.286
287/302	0.287	0.302
303/318	0.303	0.318
319/333	0.319	0.333
334/349	0.334	0.349
350/365	0.350	0.365
366/380	0.366	0.380
381/396	0.381	0.396
397/412	0.397	0.412
413/427	0.413	0.427
428/443	0.428	0.443
444/459	0.444	0.459
460/474	0.460	0.474
475/490	0.475	0.490

RANGE CODE	CABLE DIAMETER RANGE	
	MIN.	MAX.
491/506	0.491	0.506
507/521	0.507	0.521
522/537	0.522	0.537
538/553	0.538	0.553
554/568	0.554	0.568
569/583	0.569	0.583
584/599	0.584	0.599
600/615	0.600	0.615
616/630	0.616	0.630
631/646	0.631	0.646
647/662	0.647	0.662
663/677	0.663	0.677
678/693	0.678	0.693
694/708	0.694	0.708
709/727	0.709	0.727
728/740	0.728	0.740

continued →

SB01 Splice Enclosures Accessories

Ordering Instructions – Step 3

The SB01 includes accessories that allow for up to 12 fiber splices. Additional components shown below may be ordered when more than 12 splices are required.

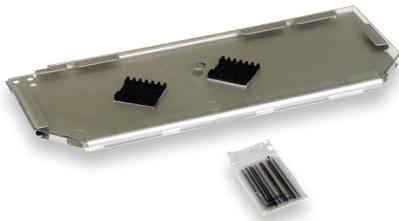

Splice Tray

The SB01 Splice Tray organizes and protects the fiber splices.

Features

- 12 single-fused fiber splice capacity
- Includes 13 splice protection sleeves

Ordering Information

MODEL	AFL NO.
SB01 Splice Tray	ST1



TT1 Transition Tray

The SB01 Transition Tray is used to divide fibers into groups for routing into splice trays. To be used for OPGW cables containing stainless steel tubes.

Features

- 48 fiber capacity
- Used in conjunction with SB01 Furcation Kit
- Not required for ST1-72 tray
- Not required with AlumaCore OPGW designs

Ordering Information

MODEL	AFL NO.
SB01 Transition Tray	TT1



72 Fiber Splice Tray

The 72 Fiber Splice Tray is used to organize and protect up to 72 single fused fibers in the SB01 splice enclosure.

Features

- 72 single-fused fiber splice capacity
- Protection sleeves sold separately

Ordering Information

MODEL	AFL NO.
72 Fiber Splice Tray	ST1-72



SB01 Furcation Kit

The SB01 Furcation Kit includes the materials required to properly divide fibers into groups inside the SB01 splice enclosure.

Features

- Contains tubing to protect and guide fibers inside the splice enclosure
- Includes cable ties to secure buffer tubes to the splice tray

Ordering Information

MODEL	AFL NO.
SB01 Furcation Kit	SB01FK

CB-30-3AL External Coil Bracket

Features

- Stores extra length of AFL-ADSS® cable
- Aluminum Material
- For use with AFL's Apex® models (X-2, X-2S, X-3, X-3H) LG-250, LG-350 and LG-350-AC sealed splice closures
- Shipped in three pieces and requires field assembly
- Can be bolted or banded to structure
- Mounting bracket available for Apex® and LG Series Sealed Splice Closures

Estimated Cable Storage Lengths and Loading Capacity

CABLE O.D. (IN)	ESTIMATED CABLE LENGTH (FT)	LOADING CAPACITY (LBS)
0.50	250	400
0.75	150	
1.00	100	

NOTE: For cable storage capacity greater than either of the values in table, please contact AFL.

Installation Diagram

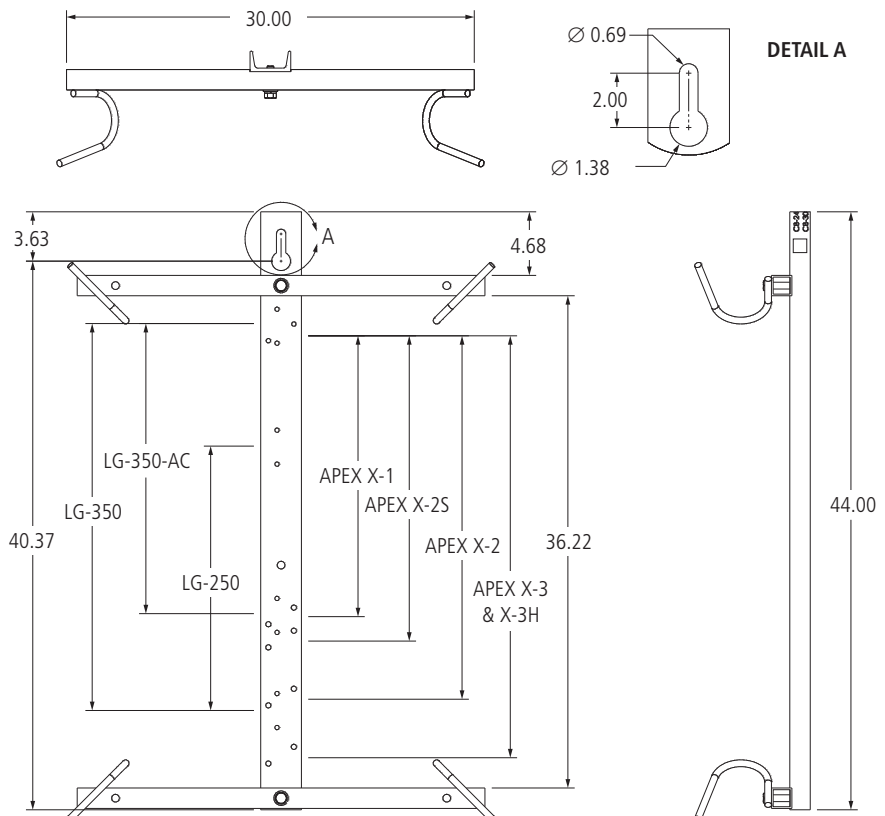
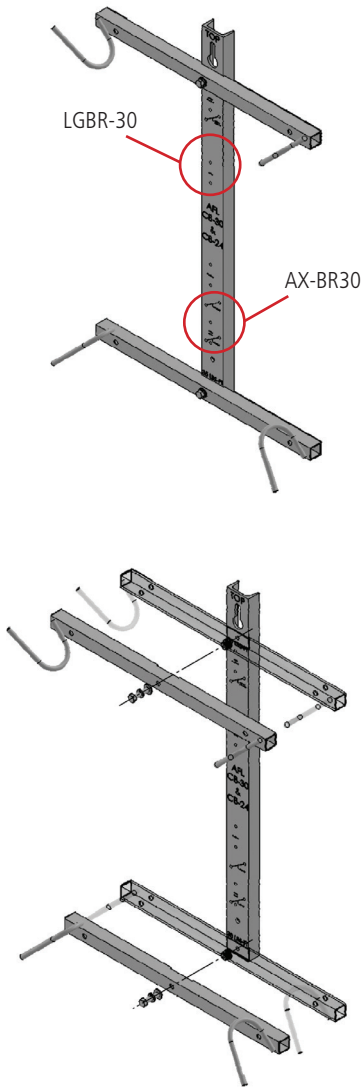

INSTALLATION NOTES:

1. Place tube assemblies in location as shown at right.
2. Stainless steel bolts to be torqued to 35 lbs-ft.

Ordering Information

MODEL	AFL NO.
CB-30-3AL ADSS Coil Storage Bracket for LG Series Sealed Splice Closures	CB-30-3AL
Pole/wall mount kit for Apex X-2 and X-2S Sealed Splice Closures	AX-BR30
Pole/wall mount kit for Apex X-3 and X-3H Sealed Splice Closures	AX-BR33
Mounting Bracket for LG Series Sealed Splice Closures	LGBR-30

CB-44-3AL External Coil Bracket

Features

- Stores extra length of ADSS or OPGW
- Aluminum Material
- For use with SB01 and Opti-Guard splice enclosures
- Shipped in three pieces, requires field assembly
- Can be bolted or banded to structure

Estimated Cable Storage Lengths and Loading Capacity

CABLE O.D. (IN)	ESTIMATED CABLE LENGTH (FT)	LOADING CAPACITY (LBS)
0.50	400	400
0.75	200	
1.00	150	

NOTE: For cable storage capacity greater than either of the values in table, please contact AFL.

Dimensions

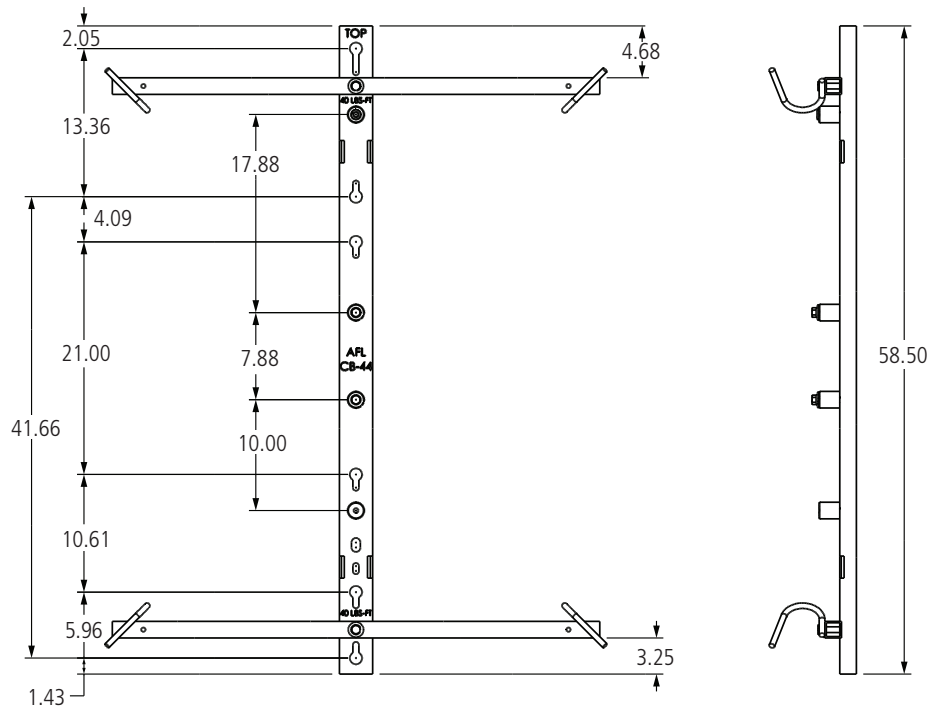
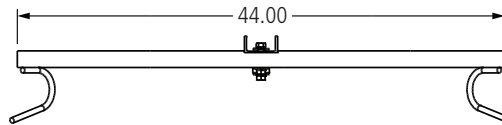

NOTE:
Place tube assemblies in location as shown.

Ordering Information

MODEL	AFL NO.
CB-44-3AL External Coil Bracket	CB-44-3AL

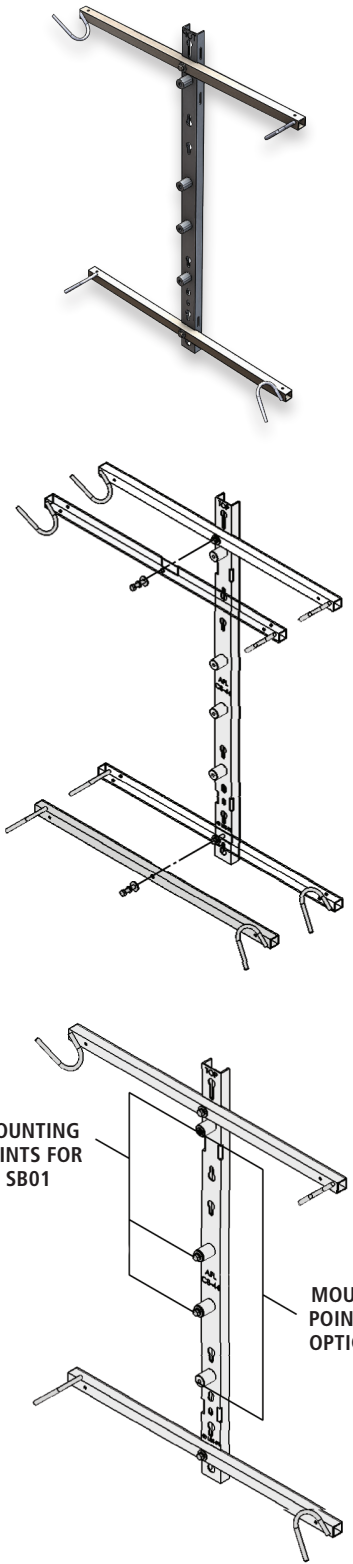



Sealed Fiber Optic Splice Closures

AFL's sealed fiber optic splice closures are designed to simplify splice management and maintenance. Intuitive engineering design reduces the installation time and complexity associated with fiber splicing in the field. No heat, adhesives, drills or powered equipment for installation or re-entry are required, just simply use a common can wrench to access and install cable. These closures are durable, easy-to-install and will increase productivity, reduce labor expenses, and last the life of your plant.

Features

- LG Series closures support stranded loose tube, Uniflex or ribbon fiber cables in either armored or dielectric configurations
- New Apex® Sealed Closures also support "rollable ribbon" fiber types including AFL's SpiderWeb Ribbon® (SWR®)
- Fully sealed to protect fiber and splices ensuring longevity
- Fully kitted with all parts to install cables

Specifications

DESCRIPTION	MODEL							
	LG-55-U-0	APEX X-2	APEX X-2S	LG-150-U-0	LG-250-U-0	LG-350-U-0	LG-350-AC	LG-350XL-U-0
Splice Capacity (Max.) – Single, Mass, Mechanical	24, n/a, 24	432, 3456, 864	216, 1728, 432	48, 192, 48	144, 432, 48	480, 1152, 108 ²	144, 432, 48	864, 2592, 288
Number of Splice Trays (Max.) – Single, Mass, Mechanical	1, n/a, 1	6		4, 3, 4		12, 8, 8	4, 3, 4	9, 9, 9
Cable Entrance Configuration	In-line / Butt	Butt						
Cable Ports	2	6		5			2 (Express Grommets) 3 (4-Drop Grommets)	5 (7 using dual port grommet Express sides)
Cable Sizes (Max. O.D.) in. (mm)	2 @ 0.70 (17.78) (splice)	Single Port: 0.40- 1.10 (10.0 - 28.0) Multi-Drop Kit: 0.20 - 0.39 (5.0 - 9.9) or flat drop		5 @ 0.62 (15.748)		3 @ 0.80 (20.32) 2 @ 1.00 (25.4)	2 @ 1.0 (25.4) 12 @ 0.312 (7.9248) Flat or 0.250" (6.35) Round	3 @ 1.08 (27.432) 2 @ 1.18 (29.972)
Testing - Cable Retention (100 lbs) - Water Resistance (waterhead) - Impact Resistance (0-40 °C) - Chemical Resistance - Cable Flexing	Passed 20 ft. Passed Passed Passed	—					Passed 20 ft. Passed Passed Passed	
Dimensions – (L x D) in. (mm)	14.00 x 4.00 (35.6 x 10.16)	25.0 x 12.0 (64 x 30)	20.0 x 12.0 (51 x 30)	16.25 x 8.75 (412.75 x 222.3)	19.0 x 8.75 (482.6 x 222.3)	28.00 x 10.00 (71.12 x 25.4)	20 x 10 (51 x 25.4)	31.00 x 12.00 (78.74 x 30.48)
Weight – lbs. (kg)	3.0 (1.36)	25 (11.3)	22 (10)	10.5 (4.76)	10.5 (4.76)	16 (7.26)	12.0 (5.44)	25 (11.34)

NOTES: 1. For the LG-250-U-0; 36 mechanical splices only using the LL-2448 splice tray.
2. For the LG-350-U-0; 108 mechanical splices only using the LL-2448 splice tray.

Qualifications

GOVERNING BODY	STANDARD CODE
Telcordia	GR-771
Rural Utilities Service (RUS)	Listed

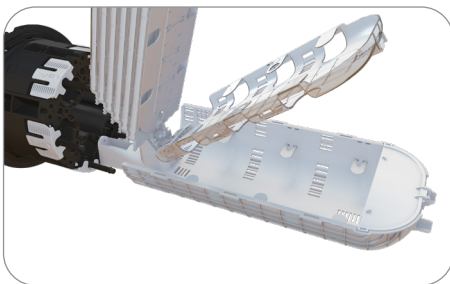

Open to access Apex X-3 splice trays and lock at 72 degrees

Apex® X-3 Sealed Splice Closure

The Apex X-3 is a sealed splice closure designed for protecting optical fiber splices in both above- or below-grade applications in a butt configuration. The Apex X-3 is capable of up to 864 single fusion, 1296 mass fusion with standard ribbon, or 5184 (200 μm, 2592 max for 250 μm) mass fusion with “rollable ribbon” fiber types such as AFL’s SpiderWeb Ribbon® (SWR®). Cables are sealed by a unique wedge system spaced evenly around the circumference of the closure’s base. Each cable seal is opened by a press-to-release lever and sealing is completed by actuating a single screw for each cable. Each cable is sealed individually, ensuring original craftsmanship when cables may be added at a later date. Up to 6 splice trays are attached and hinge off a central organizer. A plastic slack storage basket resides underneath the trays with ample tie down points for managing tube and fiber slack.

Features

- Individual cable sealing ports with tool-less release mechanism and gel sealing
- Hinging, lockable splice trays
- Plastic slack storage basket with optional segmented basket to separate ribbon and loose tube slack storage
- Six cable ports with up to six ground lugs
- Capable of up to 16 drop cables with an expressed distribution cable using multi-drop entry kits
- Splice trays with universal splice modules capable of holding single fusion, mass fusion and mechanical splices as well as other devices such as passive optical splitters
- Dome-to-base O-ring seal retained into dome to prevent loss or damage, but is still replaceable if necessary

Specifications

PARAMETER	VALUE
Dimensions – L x D, in (cm)	32.0 x 14 (81.3 x 35.6)
Weight, No Trays – lb (kg)	30 lbs. (13.61 kg)
Splice Capacity – Single, Mass (SWR), Mass (Standard)	864, 5184, 1296
Splice Tray Capacity	6
Cable Diameter, Single Port, in (mm)	0.40" - 1.38" (10.16 - 35.052)
Cable Diameter, Multi-Drop Kit, in (mm)	0.20" – 0.39" (5.0 – 9.9) or flat drop
Application	Direct Bury, Handhole, Aerial, Pole/Wall
Designed in accordance with Telcordia GR-771	Up to 10 ft. water-head

Apex® X-3 Sealed Splice Closure

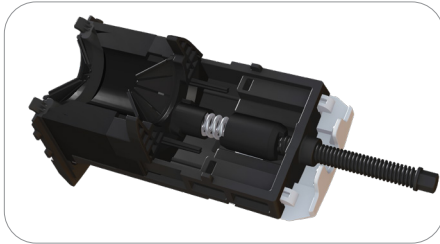

Gel Sealing

Individual wedges located evenly around the circumference of the base are removed with the press of a button. When cables are in place and ready to be sealed, the gel is compressed by a single screw, decreasing installation time. Individual port seals ensure cables never become unsealed when adding new cables at a later date.

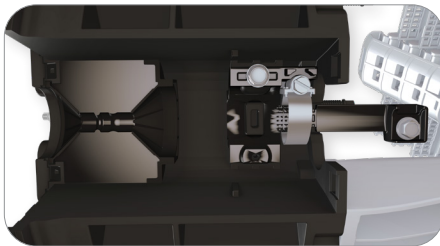

Cable Entry Ports and Cable Attachment Unit (CAU)

The cable entry ports surrounding the circumference of the base accept single cables from 0.4" to 1.38" in diameter. These ports can be expanded through the use of optional drop cable entry kits, allowing up to 4 flat drops or cables from 0.2" to 0.39" to use a single port. Additionally, each port has the capability to be paired with its own grounding lug if necessary. Closures can be configured with enough CAU kits for 0 to 6 cables from the factory. For closures with less than 6, additional cables can be added through the use of additional cable strain relief kits sold separately.

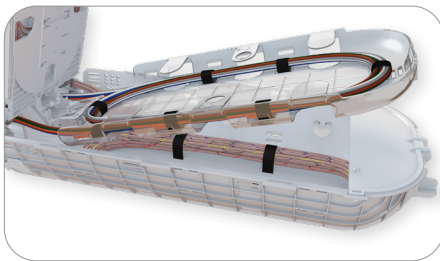

Slack Storage

A molded slack storage basket allows for use of the entire cross section of the closure to maximize storage. An optional segmented hinging basket is available to separate ribbon and loose tube slack, and can be locked in the upward position for access to expressed fibers below.

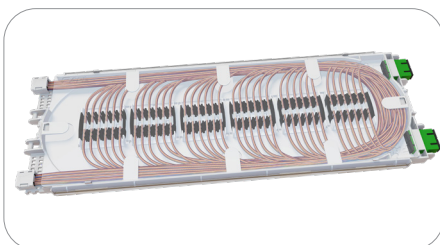

Splice Trays with Modular Splice Holders

Splice trays are organized in a hinging array that automatically lock when tilted to the upward position for easy access to the splice trays and slack storage below. The universal splice module holds up to 24 single fusion quad-stacked, 6 mass fusion or 12 mass fusion double-stacked when using SWR, or 6 mechanical splices as well as devices such as PLC splitters. This eliminates the need for specifying and stocking multiple splice trays for multiple applications such as WDM and PLC Splitters, (photo at left shown with ASC bulkhead test ports installed). This can be mix-and-match.

Ordering Information

AX	3	B	L	0	2	6	B
APEX CLOSURES	CLOSURE SIZE	BASKET TYPE	TRAY TYPE	NUMBER OF TRAYS	CABLE STRAIN RELIEF HARDWARE KITS	NUMBER OF GROUND LUGS	INNER BASKET
	3 = X-3 Size	B = X-3 Sized Basket	X = No preinstalled tray L = X-3 Square Tray Loaded with splice modules	0 1 2 3 4 5 6	0 1 2 3 4 5 6	0 1 2 3 4 5 6	X = No Inner Basket B = Include Inner Basket

Apex® X-3 Sealed Splice Closure

Splice Trays and Splice Modules

Apex X-3 closures utilize X-3 square splice trays. Trays can be ordered empty or fully loaded with splice modules. For "rollable" type ribbon such as AFL's SpiderWeb Ribbon®, closures can be fully loaded with 6 splice trays for 5184 SWR or 864 quad-stacked single fiber splices or 144 fibers per tray. For standard ribbon, AFL recommends half loaded for 18 mass splices single-stacked, or 216 fibers per tray.

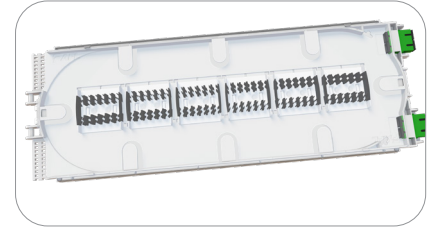

Ordering Information

DESCRIPTION	TRAY CAPACITY		AFL NO.
	SINGLE	MASS	
X-3 Tray Fully Loaded with Six (6) Splice Modules (864 fibers per tray only recommended for rollable ribbon, e.g. AFL SWR)	108 triple stacked 144 quad stacked**	864**	AX-TRAY-3-S-6
Additional splice module (18 single fusion double/quad stacked, 12 mass fusion double stacked, 6 mechanical) Pack of 20	–	–	AX-TRAY-MOD-20
X-3 Square Tray Empty	–	–	AX-TRAY-3-S-E
FP-40 40 mm Single Fiber Slim Protection Sleeve	–	–	S018262
FP-60 60 mm Single Fiber Slim Protection Sleeve	–	–	S018263

* 864 fibers per tray with mass fusion (5184 total closure capacity) only recommended for 200 µm type rollable ribbon. For 250 µm, cut capacity in half with single-stacking.

** When using AFL's Slim Protection Sleeves

Dimensions

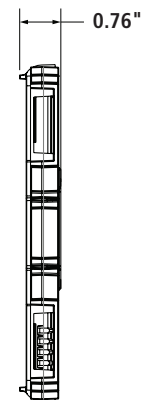
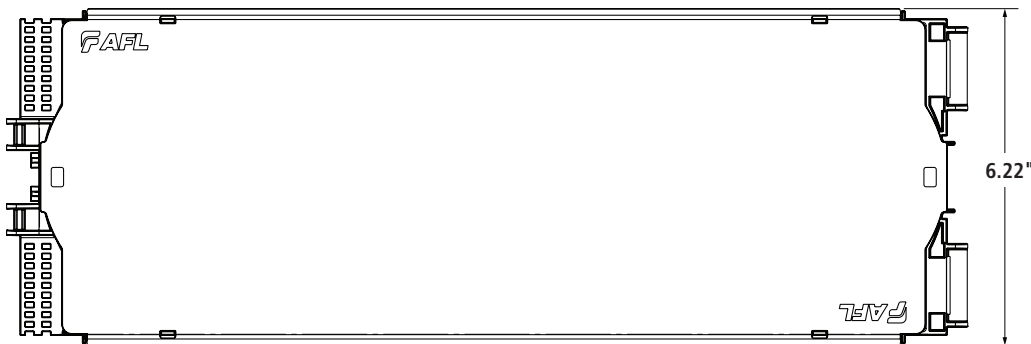
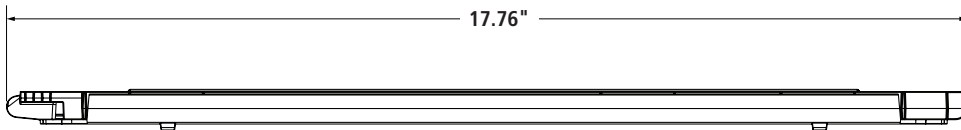

Apex® X-3 Sealed Splice Closure

Installation Kits and Accessories

The AFL Apex closure line has a variety of installation accessories kits to fit many applications. Additional accessories may be available. Contact AFL.



CAU Kit



Ring Clamp Replacement Kit



O-Ring Grease Kit

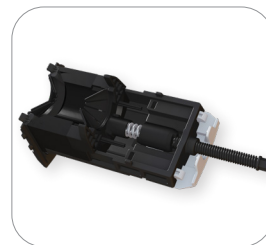

Wedge Replacement Kit

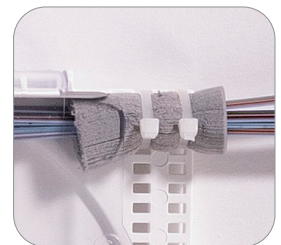

Foam Retention

Ordering Information — Replacement Kits

DESCRIPTION	AFL NO.
REPLACEMENT KITS	
X-3 and X-3H Single Cable Strain Relief/Cable Attachment Unit (CAU) Kit	AX-KIT-CBLSTRN-3
X-3 and X-3H Dome-to-Base Locking Ring Clamp Replacement Kit	AX-KIT-CLAMP-3
X-3 and X-3H Dome Replacement Kit	AX-KIT-DOME-3
X-3 and X-3H Inner Base Gel Replacement Kit	AX-KIT-GEL-3
X-3 Inner Basket Kit	AX-KIT-SBASKET-3
Apex O-Ring Grease, Pack of 10	AX-KIT-GREASE-10
X-3 and X-3H Dome to Base O-Ring Replacement Kit	AX-KIT-ORING-3
X-3 and X-3H Wedge Replacement Kit	AX-KIT-WEDGE-3
WTC-SWR Bundle Splice Tray Retention Kit - Includes 25 foam grommets for retaining SWR bundles to splice trays	HW000406
Velcro, 75 Foot Length Roll – For securing SWR bundles in the slack basket	FC001759



Apex Aerial Hanger Bracket



Apex Pole/Wall Mount



Adjustable Aerial Hanger Bracket



Mesh Transition Tubing



Universal Installation Stand

Ordering Information — Accessories

DESCRIPTION	AFL NO.
ACCESSORIES	
X-3 and X-3H Pole/wall mount kit	AX-BR33
Aerial strand mount hanger kit	AX-KIT-AERIAL-1
Adjustable Aerial Strand Mount Hanger kit	AX-KIT-AERIAL-ADJ
ADSS Aerial hanger brackets	AX-KIT-AERIAL-ADSS
X-3 and X-3H Multi-Drop Cable Entry Kit (fits up to 4 cables 0.20" to 0.39" in diameter or flat drop cable)	AX-KIT-DROP-4-3
Apex Internal Multiple Ground Bonding Kit	AX-KIT-GNDLD-5
Apex Cable Bonding Kit (Bonds armored cable sheath to ground) – Pack of 10	AX-KIT-GROUND-10
1/4" Colored Mesh Transition Tubing, 250' Spool (*Replace "XX" with color per TIA-598 color code - BL, OR, GR, BR, SL, WH, RD, BK, YL, VI, RS or AQ)	AX-KIT-TUBE-014-XX*
Apex Universal Installation Stand	AX-KIT-U-STAND

Apex® X-3 Sealed Splice Closure

Installation Accessories (cont.)

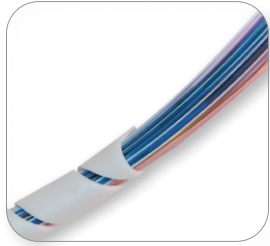

Silicone Spiral Wrap

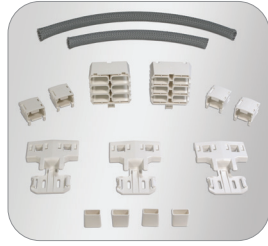

AFRS Kit 1

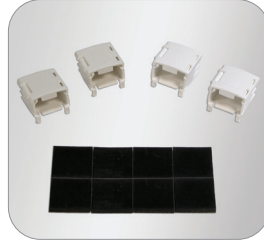

AFRS Kit 2

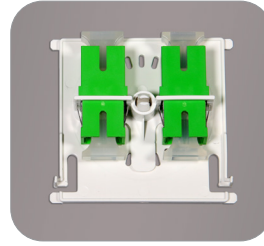

SC Bulkhead Adapter Kit

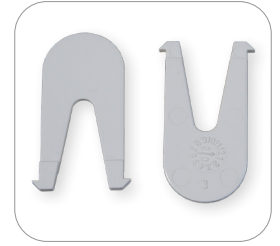

Replacement Slack Storage Basket Tabs

Ordering Information — Accessories

DESCRIPTION	AFL NO.
ACCESSORIES	
Silicone Spiral Wrap, 5.5 Foot Length	FC001657
Apex Advanced Fiber Retention System (AFRS) Kit 1 – Used for Ribbon Cable (Flat Matrix, SWR, Tubed, Central Core). Kit includes: Mesh Basket Adapter (2 ea.), Mesh Housing (2 ea.), Mesh Insert (24 ea.), V-Clips (12 ea.), and Clean Cut Gray Mesh (13 ft.).	AX-KIT-AFRSRBN
Apex AFRS Kit 2 – Used for Loose Tube Cable. Kit includes: V-Clip (24 ea.) and Retention Pads (6 sheets of 8 pads)	AX-KIT-AFRSLT
Apex AFRS Kit 3 – V-Clip bulk kit. Includes: V-Clips (120 ea.) and Mesh Inserts (120 ea.)	AX-KIT-AFRSVC-120
Apex AFRS Kit 4 – Mesh bulk kit. Includes: Clean Cut Gray Mesh (100 ft.)	AX-KIT-AFRSMESH-100FT
Apex AFRS Kit 5 – Mesh Housing bulk kit. Includes: Mesh Basket Adapter (10 ea.) and Mesh Housing (10 ea.)	AX-KIT-AFRSAH-10
Apex AFRS Kit 6 – Mesh Basket Adapter bulk kit. Includes: Mesh Basket Adapter (10 ea.)	AX-KIT-AFRSA-10
Apex Bulkhead Kit with Plate SC/APC Adapters, 1 kit	AX-TRAY-ASC
Apex Bulkhead Kit with Plate with SC/UPC Adapters, 1 kit	AX-TRAY-USC
Apex Bulkhead Kit with Plate SC/APC Adapters, 6 pc kit	AX-TRAY-ASC-6
Apex Bulkhead Kit with Plate SC/UPC Adapters, 6 pc kit	AX-TRAY-USC-6
Apex Replacement Slack Storage Basket Tabs – Pack of 25	AX-KIT-BTAB-25



Apex® X-3H Sealed Splice Closure

The Apex X-3H is a sealed splice closure designed for protecting optical fiber splices in both above- or below-grade applications in a butt configuration. The Apex X-3H is capable of up to 1728 mass fusion with standard ribbon or 6912 (200 μm, 3456 max for 250 μm) mass fusion with “rollable ribbon” fiber types such as AFL’s SpiderWeb Ribbon® (SWR®). Cables are sealed by a unique wedge system spaced evenly around the circumference of the closure’s base. Each cable seal is opened by a press-to-release lever and sealing is completed by actuating a single screw for each cable. Each cable is sealed individually, ensuring original craftsmanship when cables may be added at a later date. Up to 8 splice trays are attached and hinge off a central organizer. A plastic slack storage basket resides underneath the trays with ample tie down points for managing tube and fiber slack.



Features

- Individual cable sealing ports with tool-less release mechanism and gel sealing
- Hinging, lockable splice trays
- Plastic slack storage basket designed for high count WTC with SWR and other rollable ribbon cable
- Six cable ports with up to six ground lugs
- Optimized for 6912 200 μm fiber end splice
- Splice trays with universal splice modules capable of holding single fusion, mass fusion and mechanical splices as well as other devices such as passive optical splitters
- Dome-to-base O-ring seal retained into dome to prevent loss or damage, but is still replaceable if necessary

Specifications

PARAMETER	VALUE
Dimensions – L x D, in (cm)	32.0 x 14 (81.3 x 35.6)
Weight, No Trays – lb (kg)	30 (13.6)
Splice Capacity – Mass (SWR), Mass (Standard)	6912, 1728
Splice Tray Capacity	8
Cable Diameter, Single Port, in (mm)	0.40" - 1.38" (10.16 - 35.052)
Application	Handhole, Aerial, Pole/Wall, Direct Bury

Apex® X-3H Sealed Splice Closure

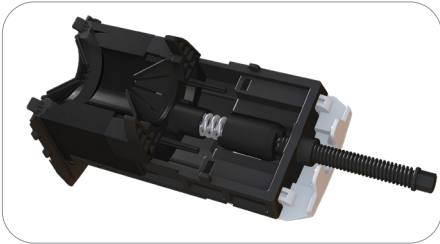

Gel Sealing

Individual wedges located evenly around the circumference of the base are removed with the press of a button. When cables are in place and ready to be sealed, the gel is compressed by a single screw, decreasing installation time. Individual port seals ensure cables never become unsealed when adding new cables at a later date.

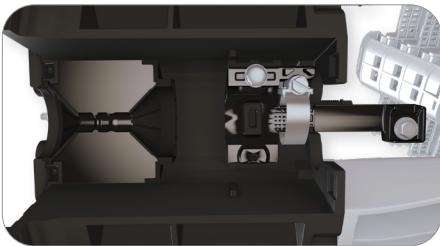

Cable Entry Ports and Cable Attachment Unit (CAU)

The cable entry ports surrounding the circumference of the base accept single cables from 0.4" to 1.38" in diameter. Additionally, each port has the capability to be paired with its own grounding lug if necessary. Closures can be configured with enough strain relief kits for 0 to 6 cables from the factory. For closures with less than 6, additional cables can be added through the use of additional cable strain relief kits sold separately.

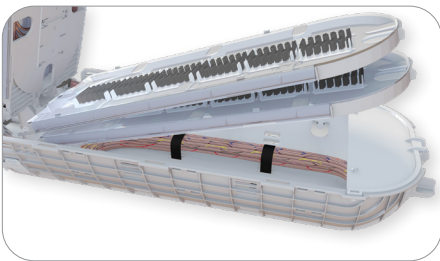

Slack Storage

A molded slack storage basket allows for use of the entire cross section of the closure to maximize storage.

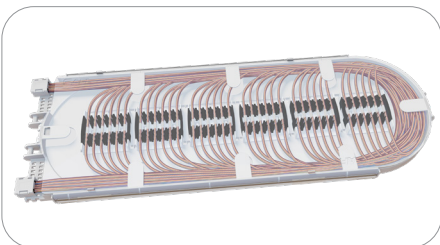

Splice Trays with Modular Splice Holders

Apex X-3H round splice trays are organized in a hinging array that automatically lock when tilted to the upward position for easy access to the splice trays and slack storage below. The Apex X-3H round splice trays are only compatible with the X-3H closure. The universal splice module holds up to 24 single fusion, 6 mass fusion or 12 mass fusion double-stacked when using SWR, or 6 mechanical splices as well as devices such as PLC splitters. This eliminates the need for specifying and stocking multiple splice trays for multiple applications.

Ordering Information

AX	—	3H	—	B	—	L	—	0	—	2	—	6	—	X
APEX CLOSURES		CLOSURE SIZE		BASKET TYPE		TRAY TYPE		NUMBER OF TRAYS		CABLE STRAIN RELIEF HARDWARE KITS		NUMBER OF GROUND LUGS		INNER BASKET
		3H = X-3H Size		B = X-3H Sized Basket		X = No preinstalled tray L = X-3 Square Tray Loaded with splice modules		0 OR 8		0 1 2 3 4 5 6		0 1 2 3 4 5 6		X = No Inner Basket

Apex® X-3H Sealed Splice Closure

Splice Trays and Splice Modules

Apex X-3H closures utilize X-3H round splice trays. Trays can be ordered empty or fully loaded with splice modules. For “rollable” type ribbon such as AFL’s SpiderWeb Ribbon®, trays can be fully loaded for 72 double-stacked mass splices, or 864 fibers per tray. For standard ribbon, AFL recommends half loaded for 18 mass splices single-stacked, or 216 fibers.

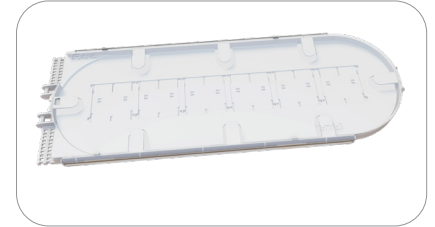

Ordering Information

DESCRIPTION	MASS	AFL NO.
	X-3H Tray Fully Loaded with Six (6) Splice Modules (864 fibers per tray only recommended for rollable ribbon, e.g. AFL SWR)	864**
Additional splice module (18 single fusion triple stacked, 12 mass fusion double stacked, 6 mechanical) – Pack of 20	–	AX-TRAY-MOD-20
X-3H Round Tray Empty	–	AX-TRAY-3-R-E
FP-40 40 mm Single Fiber Slim Protection Sleeve	–	S018262
FP-60 60 mm Single Fiber Slim Protection Sleeve	–	S018263

* 864 fibers per tray with mass fusion (6912 total closure capacity) only recommended for 200 μm type rollable ribbon. For 250 μm, cut capacity in half with single-stacking.

** When using AFL’s Slim Protection Sleeves

Dimensions

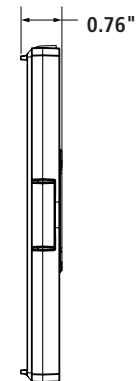
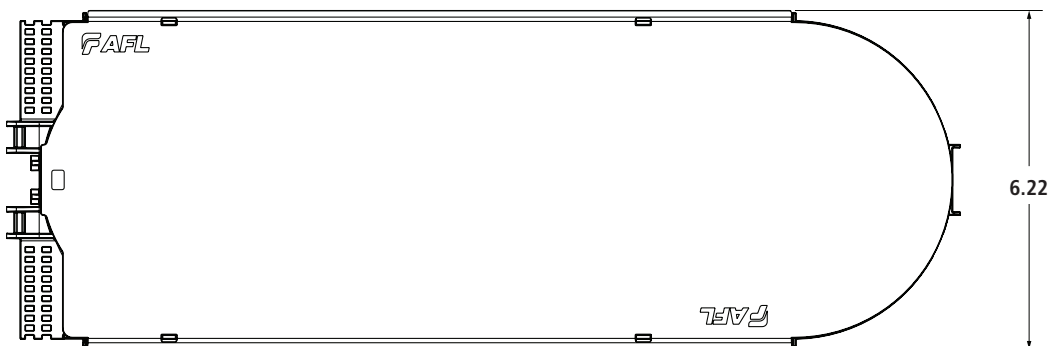
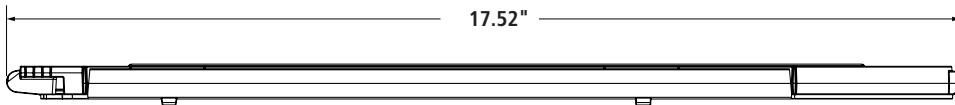

Apex® X-3H Sealed Splice Closure

Installation Kits and Accessories

The AFL Apex closure line has a variety of installation accessories kits to fit many applications. Additional accessories may be available. Contact AFL.



CAU Kit



Ring Clamp Replacement Kit



O-Ring Grease Kit



Wedge Replacement Kit

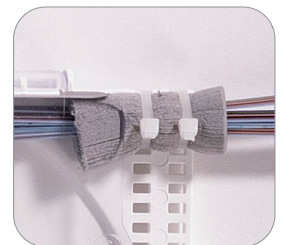

Foam Retention

Ordering Information — Replacement Kits

DESCRIPTION	AFL NO.
REPLACEMENT KITS	
X-3 and X-3H Single Cable Strain Relief/Cable Attachment Unit (CAU) Kit	AX-KIT-CBLSTRN-3
X-3 and X-3H Dome-to-Base Locking Ring Clamp Replacement Kit	AX-KIT-CLAMP-3
X-3 and X-3H Dome Replacement Kit	AX-KIT-DOME-3
X-3 and X-3H Inner Base Gel Replacement Kit	AX-KIT-GEL-3
Apex O-Ring Grease, Pack of 10	AX-KIT-GREASE-10
X-3 and X-3H Dome to Base O-Ring Replacement Kit	AX-KIT-ORING-3
X-3 and X-3H Wedge Replacement Kit	AX-KIT-WEDGE-3
WTC-SWR Bundle Splice Tray Retention Kit - Includes 25 foam grommets for retaining SWR bundles to splice trays	HW000406
Velcro, 75 Foot Length Roll – For securing SWR bundles in the slack basket	FC001759



Apex Aerial Hanger Bracket



Apex Pole/Wall Mount



Adjustable Aerial Hanger Bracket



Mesh Transition Tubing



Universal Installation Stand

Ordering Information — Accessories

DESCRIPTION	AFL NO.
ACCESSORIES	
X-3 and X-3H Pole/wall mount kit	AX-BR33
Aerial strand mount hanger kit	AX-KIT-AERIAL-1
Adjustable Aerial Strand Mount Hanger kit	AX-KIT-AERIAL-ADJ
ADSS Aerial hanger brackets	AX-KIT-AERIAL-ADSS
X-3 and X-3H Multi-Drop Cable Entry Kit (fits up to 4 cables 0.20" to 0.39" in diameter or flat drop cable)	AX-KIT-DROP-4-3
Apex Internal Multiple Ground Bonding Kit	AX-KIT-GNDLD-5
Apex Cable Bonding Kit (Bonds armored cable sheath to ground) – Pack of 10	AX-KIT-GROUND-10
1/4" Colored Mesh Transition Tubing, 250' Spool (*Replace "XX" with color per TIA-598 color code - BL, OR, GR, BR, SL, WH, RD, BK, YL, VI, RS or AQ)	AX-KIT-TUBE-014-XX*
Apex Universal Installation Stand	AX-KIT-U-STAND

Apex® X-3H Sealed Splice Closure

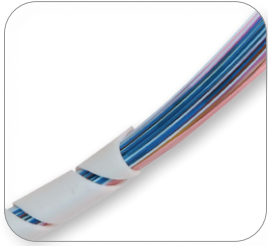

Silicone Spiral Wrap

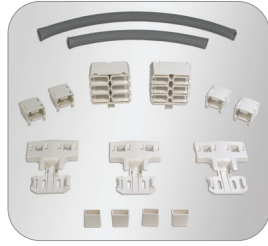

AFRS Kit 1

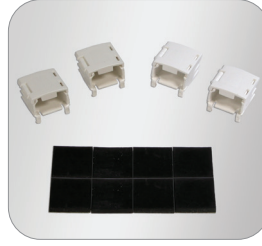

AFRS Kit 2

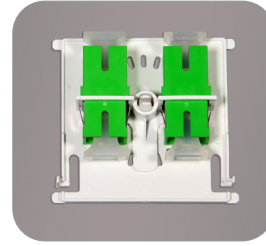

SC Bulkhead Adapter Kit

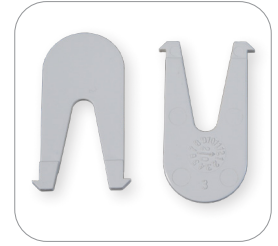

Replacement Slack Storage Basket Tabs

Ordering Information — Accessories

DESCRIPTION	AFL NO.
ACCESSORIES	
Silicone Spiral Wrap, 5.5 Foot Length	FC001657
Apex Advanced Fiber Retention System (AFRS) Kit 1 – Used for Ribbon Cable (Flat Matrix, SWR, Tubed, Central Core). Kit includes: Mesh Basket Adapter (2 ea.), Mesh Housing (2 ea.), Mesh Insert (24 ea.), V-Clips (12 ea.), and Clean Cut Gray Mesh (13 ft.).	AX-KIT-AFRSRBN
Apex AFRS Kit 2 – Used for Loose Tube Cable. Kit includes: V-Clip (24 ea.) and Retention Pads (6 sheets of 8 pads)	AX-KIT-AFRSLT
Apex AFRS Kit 3 – V-Clip bulk kit. Includes: V-Clips (120 ea.) and Mesh Inserts (120 ea.)	AX-KIT-AFRSVC-120
Apex AFRS Kit 4 – Mesh bulk kit. Includes: Clean Cut Gray Mesh (100 ft.)	AX-KIT-AFRSMESH-100FT
Apex AFRS Kit 5 – Mesh Housing bulk kit. Includes: Mesh Basket Adapter (10 ea.) and Mesh Housing (10 ea.)	AX-KIT-AFRSAH-10
Apex AFRS Kit 6 – Mesh Basket Adapter bulk kit. Includes: Mesh Basket Adapter (10 ea.)	AX-KIT-AFRSA-10
Apex Bulkhead Kit with Plate SC/APC Adapters, 1 kit	AX-TRAY-ASC
Apex Bulkhead Kit with Plate with SC/UPC Adapters, 1 kit	AX-TRAY-USC
Apex Bulkhead Kit with Plate SC/APC Adapters, 6 pc kit	AX-TRAY-ASC-6
Apex Bulkhead Kit with Plate SC/UPC Adapters, 6 pc kit	AX-TRAY-USC-6



Apex® X-2 Sealed Splice Closure

The Apex X-2 is a sealed splice closure designed for protecting optical fiber splices in both above- or below-grade applications in a butt configuration. The Apex X-2 is capable of up to 576 single fusion, 1152 mass fusion with standard ribbon, or 3456 (200 μm, 1728 max for 250 μm) mass fusion with “rollable ribbon” fiber types such as AFL’s SpiderWeb Ribbon® (SWR®). Cables are sealed by a unique wedge system spaced evenly around the circumference of the closure’s base. Each cable seal is opened by a press-to-release lever and sealing is completed by actuating a single screw for each cable. Each cable is sealed individually, ensuring original craftsmanship when cables may be added at a later date. Up to 6 splice trays are attached and hinge off a central organizer. A plastic slack storage basket resides underneath the trays with ample tie down points for managing tube and fiber slack.

Features

- Individual cable sealing ports with tool-less release mechanism and gel sealing
- Hinging, lockable splice trays
- Plastic slack storage basket with optional segmented basket to separate ribbon and loose tube slack storage
- Six cable ports with up to six ground lugs
- Capable of up to 16 drop cables with an expressed distribution cable using multi-drop entry kits
- Splice trays with universal splice modules capable of holding single fusion, mass fusion and mechanical splices as well as other devices such as passive optical splitters
- Dome-to-base O-ring seal retained into dome to prevent loss or damage, but is still replaceable if necessary

Specifications

PARAMETER	VALUE
Dimensions – L x D, in (cm)	25.0 x 12.0 (64 x 30)
Weight, No Trays – lb (kg)	25 (11.3)
Splice Capacity – Single, Mass (SWR), Mass (Standard)	576, 3456, 1152
Splice Tray Capacity	6
Cable Diameter, Single Port, in (mm)	0.40" – 1.10" (10.0 – 28.0)
Cable Diameter, Multi-Drop Kit, in (mm)	0.20" – 0.39" (5.0 – 9.9) or flat drop
Application	Direct Bury, Handhole, Aerial, Pole/Wall
Testing	Test to and Passed GR-771-CORE 20 ft. Waterhead test
Temperature Operating	-40°F to 149°F -40°C to 65°C

Apex® X-2 Sealed Splice Closure

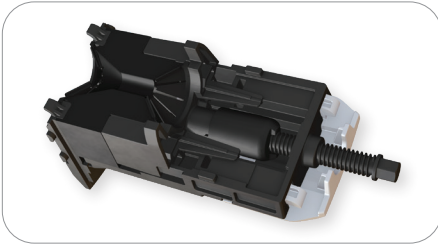

Gel Sealing

Individual wedges located evenly around the circumference of the base are removed with the press of a button. When cables are in place and ready to be sealed, the gel is compressed by a single screw, decreasing installation time. Individual port seals ensure cables never become unsealed when adding new cables at a later date.

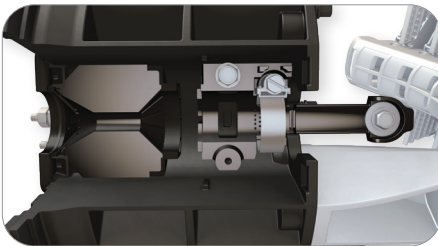

Cable Entry Ports and Strain Relief

The cable entry ports surrounding the circumference of the base accept single cables from 0.4" to 1.1" in diameter. These ports can be expanded through the use of optional drop cable entry kits, allowing up to 4 flat drops or cables from 0.2" to 0.39" to use a single port. Additionally, each port has the capability to be paired with its own grounding lug if necessary. Closures can be configured with enough strain relief kits for 0 to 6 cables from the factory. For closures with less than 6, additional cables can be added through the use of additional cable strain relief kits sold separately.

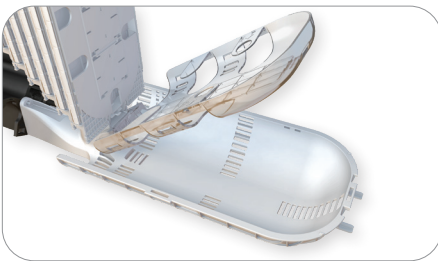

Slack Storage

A molded slack storage basket allows for use of the entire cross section of the closure to maximize storage. An optional segmented hinging basket is available to separate ribbon and loose tube slack, and can be locked in the upward position for access to expressed fibers below.

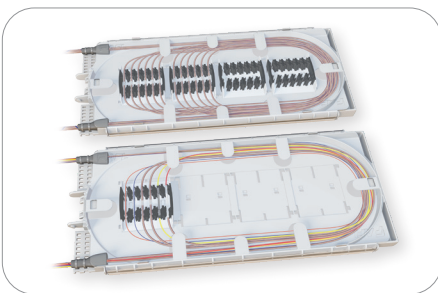

Splice Trays with Modular Splice Holders

Splice trays are organized in a hinging array that automatically lock when tilted to the upward position for easy access to the splice trays and slack storage below. The universal splice module holds up to 24 single fusion, 6 mass fusion or 12 mass fusion double-stacked when using SWR, or 6 mechanical splices as well as devices such as PLC splitters or OADM devices. This eliminates the need for specifying and stocking multiple splice trays for multiple applications.

Ordering Information

AX	2	B	L	0	2	6	B
APEX CLOSURES	CLOSURE SIZE	BASKET TYPE	TRAY TYPE	NUMBER OF TRAYS	CABLE STRAIN RELIEF HARDWARE KITS	NUMBER OF GROUND LUGS	INNER BASKET
	2 = X-2 Size	B = X-2 Sized Basket	X = No preinstalled tray L = X-2 Tray Loaded with splice modules	0 1 2 3 4 5 6	0 1 2 3 4 5 6	0 1 2 3 4 5 6	X = No Inner Basket B = Include Inner Basket

Apex® X-2 Sealed Splice Closure

Splice Trays and Splice Modules

Apex X-2 closures utilize X-2 size splice trays. Trays can be ordered fully loaded or half loaded with splice modules. For “rollable” type ribbon such as AFL’s SpiderWeb Ribbon®, trays can be fully loaded for 48 double-stacked mass splices, or 576 fibers total per tray. For standard ribbon, AFL recommends partially loaded for up to 16 mass splices single-stacked, or 192 fibers. Adapter kits available to install FOOSC® A-B optical trays.

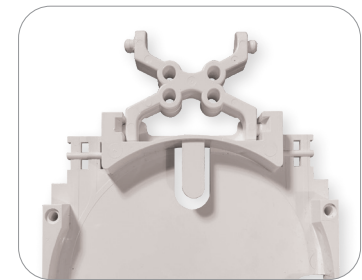
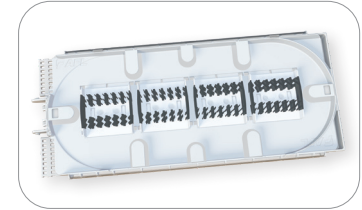

Ordering Information

DESCRIPTION	TRAY CAPACITY		AFL NO.
	SINGLE	MASS	
X-2 Tray Loaded with Two Splice Modules	48**	288	AX-TRAY-2-2
X-2 Tray Fully Loaded with Four Splice Modules (576 fibers per tray only recommended for rollable ribbon, e.g. AFL SWR)	96**	576*	AX-TRAY-2-4
Additional splice module (18 single fusion triple stacked, 12 mass fusion double stacked, 6 mechanical) – Pack of 20	–	–	AX-TRAY-MOD-20
X-2 Tray Empty	–	–	AX-TRAY-2-E
FP-40 40 mm Single Fiber Slim Protection Sleeve	–	–	S018262
FP-60 60 mm Single Fiber Slim Protection Sleeve	–	–	S018263

* 576 fibers per tray with mass fusion double-stacking (3456 total closure capacity) only recommended for 200 μm type rollable ribbon. For 250 μm, cut capacity in half with single-stacking.

** When using AFL’s Slim Protection Sleeves

Dimensions

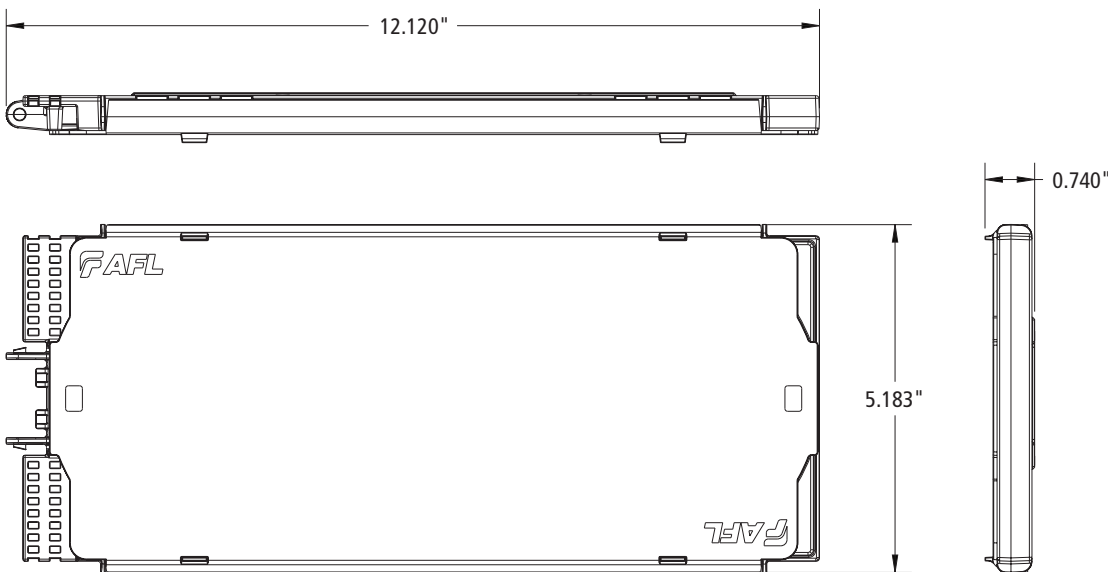

Apex® X-2 Sealed Splice Closure

Installation Kits and Accessories

The AFL Apex closure line has a variety of installation accessories kits to fit many applications. Additional accessories may be available. Contact AFL.



CAU Kit



Ring Clamp Replacement Kit



O-Ring Grease Kit



Wedge Replacement Kit

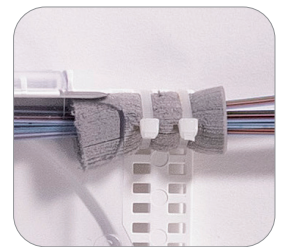

Foam Retention

Ordering Information — Replacement Kits

DESCRIPTION	AFL NO.
REPLACEMENT KITS	
X-2 and X-2S Single Cable Strain Relief/Cable Attachment Unit (CAU) Kit	AX-KIT-CBLSTRN
X-2 and X-2S Dome to Base O-Ring Replacement Kit	AX-KIT-ORING-2
Apex O-Ring Grease, Pack of 10	AX-KIT-GREASE-10
X-2 and X-2S Dome to Base Locking Ring Clamp Replacement Kit	AX-KIT-CLAMP-2
X-2 and X-2S Wedge Replacement Kit	AX-KIT-WEDGE-2
X-2 and X-2S Inner Base Gel Replacement Kit	AX-KIT-GEL-2
X-2 Basket and Yoke Assembly Kit. Can be used in combination with the basket cover.	AX-KIT-BASKET-2
X-2 Inner Basket Kit	AX-KIT-SBASKET-2
X-2 Dome Replacement Kit	AX-KIT-DOME-2
WTC-SWR Bundle Splice Tray Retention Kit - Includes 25 foam grommets for retaining SWR bundles to splice trays	HW000406
Velcro, 75 Foot Length Roll – For securing SWR bundles in the slack basket	FC001759



Apex Aerial Hanger Bracket



Apex Pole/Wall Mount



Adjustable Aerial Hanger Bracket



X-2 and X-2S Installation Stand

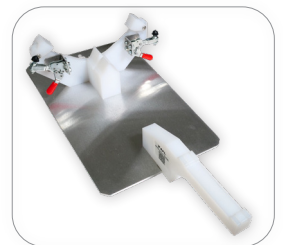

Universal Installation Stand

Ordering Information — Accessories

DESCRIPTION	AFL NO.
ACCESSORIES	
Aerial strand mount hanger kit	AX-KIT-AERIAL-1
Pole/wall mount kit	AX-BR30
Adjustable Aerial Strand Mount Hanger kit	AX-KIT-AERIAL-ADJ
ADSS Aerial hanger brackets	AX-KIT-AERIAL-ADSS
Multi-Drop Cable Entry Kit (fits up to 4 cables 0.20" to 0.39" in diameter or flat drop cable)	AX-KIT-DROP-4
X-2 and X-2S Installation Stand	FC104649
Apex Universal Installation Stand	AX-KIT-U-STAND

Apex® X-2 Sealed Splice Closure

Installation Accessories (cont.)

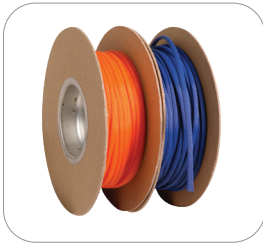

Mesh Transition Tubing

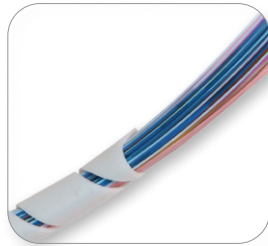

Silicone Spiral Wrap

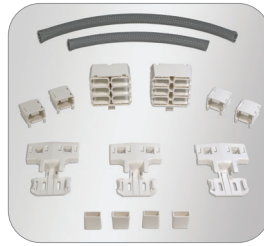

AFRS Kit 1

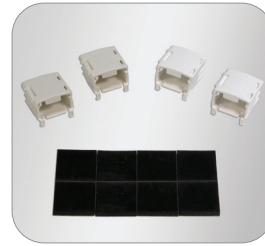

AFRS Kit 2



A-B Tray Adapter Kit

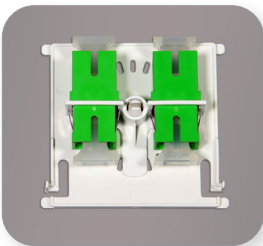

SC Bulkhead Adapter Kit

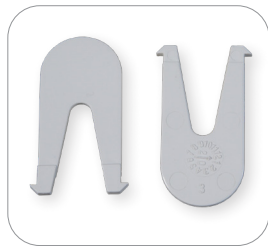

Replacement Slack Storage Basket Tabs

Ordering Information — Accessories (cont.)

DESCRIPTION	AFL NO.
ACCESSORIES	
Apex Cable Bonding Kit (Bonds armored cable sheath to ground) – Pack of 10	AX-KIT-GROUND-10
Apex Internal Multiple Ground Bonding Kit	AX-KIT-GNDLD-5
1/4" Colored Mesh Transition Tubing, 250' Spool (*Replace "XX" with color per TIA-598 color code - BL, OR, GR, BR, SL, WH, RD, BK, YL, VI, RS or AQ)	AX-KIT-TUBE-014-XX*
Silicone Spiral Wrap, 5.5 Foot Length	FC001657
Apex Advanced Fiber Retention System (AFRS) Kit 1 – Used for Ribbon Cable (Flat Matrix, SWR, Tubed, Central Core). Kit includes: Mesh Basket Adapter (2 ea.), Mesh Housing (2 ea.), Mesh Insert (24 ea.), V-Clips (12 ea.), and Clean Cut Gray Mesh (13 ft.).	AX-KIT-AFRSRBN
Apex AFRS Kit 2 – Used for Loose Tube Cable. Kit includes: V-Clip (24 ea.) and Retention Pads (6 sheets of 8 pads)	AX-KIT-AFRSLT
Apex AFRS Kit 3 – V-Clip bulk kit. Includes: V-Clips (120 ea.) and Mesh Inserts (120 ea.)	AX-KIT-AFRSVC-120
Apex AFRS Kit 4 – Mesh bulk kit. Includes: Clean Cut Gray Mesh (100 ft.)	AX-KIT-AFRSMESH-100FT
Apex AFRS Kit 5 – Mesh Housing bulk kit. Includes: Mesh Basket Adapter (10 ea.) and Mesh Housing (10 ea.)	AX-KIT-AFRSAH-10
Apex AFRS Kit 6 – Mesh Basket Adapter bulk kit. Includes: Mesh Basket Adapter (10 ea.)	AX-KIT-AFRSA-10
Apex Restoration Kit, 1000' of 144F Non-Armored Wrapping Tube Cable (Apex X-2S is in Restoration Kit)	AX-2S-B-L-4-4-X-1R1000F
Apex A-B Tray Adapter Kit, 1 Kit of 6 pieces	AX-ADPTR-ABTRAY-6
Apex A-B Tray Adapter Kit, 10 Kits of 6 pieces	AX-ADPTR-ABTRAY-60
Apex Bulkhead Kit with Plate SC/APC Adapters, 1 kit	AX-TRAY-ASC
Apex Bulkhead Kit with Plate with SC/UPC Adapters, 1 kit	AX-TRAY-USC
Apex Bulkhead Kit with Plate SC/APC Adapters, 6 pc kit	AX-TRAY-ASC-6
Apex Bulkhead Kit with Plate SC/UPC Adapters, 6 pc kit	AX-TRAY-USC-6
Apex Replacement Slack Storage Basket Tabs – Pack of 25	AX-KIT-BTAB-25

Apex® X-2 Sealed Splice Closure

Splitter Splice Trays

Passive optical splitters, or PLCs (Planar Lightwave Circuits), can be provided preinstalled into the Apex X-2 splice tray. PLCs can either be installed and splice within the same tray, or provided with a separate dedicated tray for splicing, with fibers routed between trays using protective tubing. A third option provides one additional tray to separate input and output fiber splicing.

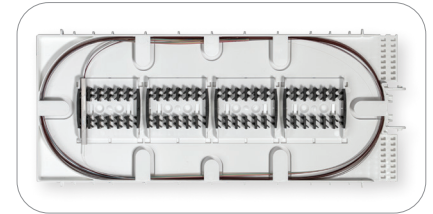

Ordering Information

DESCRIPTION	SPLIT RATIO	AFL NO.
SPLITTER MODULES FOR SPLICE TRAYS		
X-2 Tray with Four Splice Modules, (1) 1x2 PLC Splitter	1x2	AX-TRAY-2-12-1
X-2 Tray with Four Splice Modules, (1) 1x4 PLC Splitter	1x4	AX-TRAY-2-14-1
X-2 Tray with Four Splice Modules, (1) 1x8 PLC Splitter	1x8	AX-TRAY-2-18-1
X-2 Tray with Four Splice Modules, (1) 1x16 PLC Splitter	1x16	AX-TRAY-2-116-1
X-2 Tray with Four Splice Modules, (1) 1x32 PLC Splitter	1x32	AX-TRAY-2-132-1
X-2 Tray with (1) 1x2 PLC Splitter and Separate Splicing Tray with Four Splice Modules	1x2	AX-TRAY-2-12-2
X-2 Tray with (1) 1x4 PLC Splitter and Separate Splicing Tray with Four Splice Modules	1x4	AX-TRAY-2-14-2
X-2 Tray with (1) 1x8 PLC Splitter and Separate Splicing Tray with Four Splice Modules	1x8	AX-TRAY-2-18-2
X-2 Tray with (1) 1x16 PLC Splitter and Separate Splicing Tray with Four Splice Modules	1x16	AX-TRAY-2-116-2
X-2 Tray with (1) 1x32 PLC Splitter and Separate Splicing Tray with Four Splice Modules	1x32	AX-TRAY-2-132-2
X-2 Tray with (1) 1x2 PLC Splitter and 2 Separate Splicing Trays with Four Splice Modules each	1x2	AX-TRAY-2-12-3
X-2 Tray with (1) 1x4 PLC Splitter and 2 Separate Splicing Trays with Four Splice Modules each	1x4	AX-TRAY-2-14-3
X-2 Tray with (1) 1x8 PLC Splitter and 2 Separate Splicing Trays with Four Splice Modules each	1x8	AX-TRAY-2-18-3
X-2 Tray with (1) 1x16 PLC Splitter and 2 Separate Splicing Trays with Four Splice Modules each	1x16	AX-TRAY-2-116-3
X-2 Tray with (1) 1x32 PLC Splitter and 2 Separate Splicing Trays with Four Splice Modules each	1x32	AX-TRAY-2-132-3



Apex® X-2S Sealed Splice Closure

The Apex X-2S is a sealed splice closure designed for protecting optical fiber splices in both above- or below-grade applications in a butt configuration. The Apex X-2S is capable of up to 288 single fusion, 576 mass fusion with standard ribbon, or 1728 (200 μm, 864 max for 250 μm) mass fusion with “rollable ribbon” fiber types such as AFL’s SpiderWeb Ribbon® (SWR®). Cables are sealed by a unique wedge system spaced evenly around the circumference of the closure’s base. Each cable seal is opened by a press-to-release lever and sealing is completed by actuating a single screw for each cable. Each cable is sealed individually, ensuring original craftsmanship when cables may be added at a later date. Up to 6 splice trays are attached and hinge off a central organizer. A plastic slack storage basket resides underneath the trays with ample tie down points for managing tube and fiber slack.

Features

- Individual cable sealing ports with tool-less release mechanism and gel sealing
- Hinging, lockable splice trays
- Plastic slack storage basket with convenient multiple tie-down points with Velcro or tie wraps
- Six cable ports with up to six ground lugs
- Capable of up to 16 drop cables with an expressed distribution cable using multi-drop entry kits
- Splice trays with universal splice modules capable of holding single fusion, mass fusion and mechanical splices as well as other devices such as passive optical splitters
- Dome-to-base O-ring seal retained into dome to prevent loss or damage, but is still replaceable if necessary

Specifications

PARAMETER	VALUE
Dimensions – L x D, in (cm)	20.0 x 12.0 (51 x 30)
Weight, No Trays – lb (kg)	22 (10)
Splice Capacity – Single, Mass (SWR), Mass (Standard)	288, 1728, 576
Splice Tray Capacity	6
Cable Diameter, Single Port, in (mm)	0.40" – 1.10" (10.0 - 28.0)
Cable Diameter, Multi-Drop Kit, in (mm)	0.20" – 0.39" (5.0 - 9.9) or flat drop
Application	Direct Bury, Handhole, Aerial, Pole/Wall
Testing	Test to and Passed GR-771-CORE 20 ft. Waterhead test
Temperature Operating	-40°F to 149°F -40°C to 65°C

Telcordia is a registered trademark of Telcordia Technologies, Inc.

Apex® X-2S Sealed Splice Closure

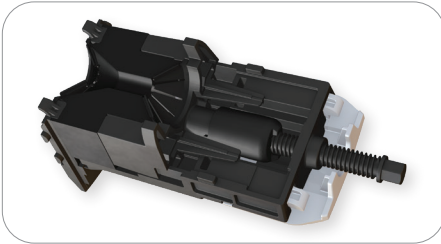

Gel Sealing

Individual wedges located evenly around the circumference of the base are removed with the press of a button. When cables are in place and ready to be sealed, the gel is compressed by a single screw, decreasing installation time. Individual port seals ensure cables never become unsealed when adding new cables at a later date.

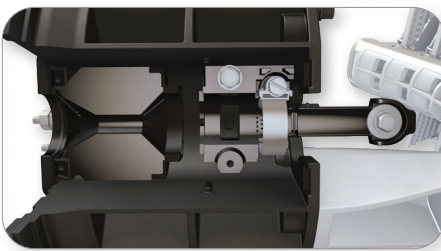

Cable Entry Ports and Strain Relief

The cable entry ports surrounding the circumference of the base accept single cables from 0.4" to 1.1" in diameter. These ports can be expanded through the use of optional drop cable entry kits, allowing up to 4 flat drops or cables from 0.2" to 0.39" to use a single port. Additionally, each port has the capability to be paired with its own grounding lug if necessary. Closures can be configured with enough strain relief kits for 0 to 6 cables from the factory. For closures with less than 6, additional cables can be added through the use of additional cable strain relief kits sold separately.



Slack Storage

A molded slack storage basket allows for use of the entire cross section of the closure to maximize storage.

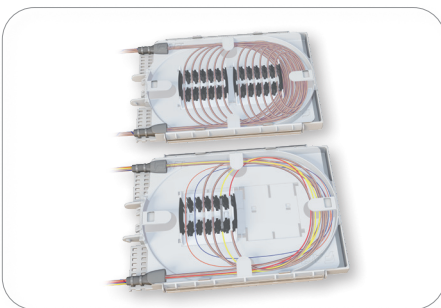

Splice Trays with Modular Splice Holders

Splice trays are organized in a hinging array that automatically lock when tilted to the upward position for easy access to the splice trays and slack storage below. The universal splice module holds up to 24 single fusion, 6 mass fusion or 12 mass fusion double-stacked when using SWR, or 6 mechanical splices as well as devices such as PLC splitters and OADM devices. This eliminates the need for specifying and stocking multiple splice trays for multiple applications.

Ordering Information

AX	—	2S	—	B	—	L	—	0	—	2	—	6	—	X
APEX CLOSURES		CLOSURE SIZE		BASKET TYPE		TRAY TYPE		NUMBER OF TRAYS		CABLE STRAIN RELIEF HARDWARE KITS		NUMBER OF GROUND LUGS		INNER BASKET
		2S = X-2S Size		B = X-2S Sized Basket		X = No preinstalled tray L = X-2S Tray Loaded with splice modules		0 1 2 3 4 5 6		0 1 2 3 4 5 6		0 1 2 3 4 5 6		X = No Inner Basket

Apex® X-2S Sealed Splice Closure

Splice Trays and Splice Modules

Apex X-2S closures utilize X-2S size splice trays. Trays can be ordered fully loaded or half loaded with splice modules. For "rollable" type ribbon such as AFL's SpiderWeb Ribbon®, trays can be fully loaded for 24 mass splices, or 288 fibers per tray. For standard ribbon, AFL recommends half loaded for 6 mass splices single-stacked, or 72 fibers. Adapter kits available to install up to four FOSC® A optical trays.

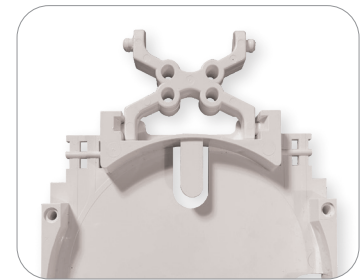
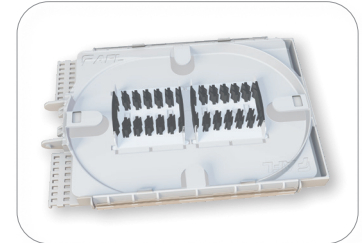

Ordering Information

DESCRIPTION	TRAY CAPACITY		AFL NO.
	SINGLE	MASS	
X-2S Tray Loaded with One Splice Module	24**	72	AX-TRAY-2S-1
X-2S Tray Fully Loaded with Two Splice Modules (288 fibers per tray only recommended for rollable ribbon, e.g. AFL SWR)	48**	288	AX-TRAY-2S-2
Additional splice module (18 single fusion triple stacked, 12 mass fusion double stacked, 6 mechanical) – Pack of 20	-	-	AX-TRAY-MOD-20
X-2S Tray Empty	-	-	AX-TRAY-2S-E
FP-40 40 mm Single Fiber Slim Protection Sleeve	-	-	S018262
FP-60 60 mm Single Fiber Slim Protection Sleeve	-	-	S018263

* 288 fibers per tray with mass fusion double-stacking (1728 total closure capacity) only recommended for 200 μm type rollable ribbon. For 250 μm, cut capacity in half with single-stacking.

** When using AFL's Slim Protection Sleeves

Dimensions

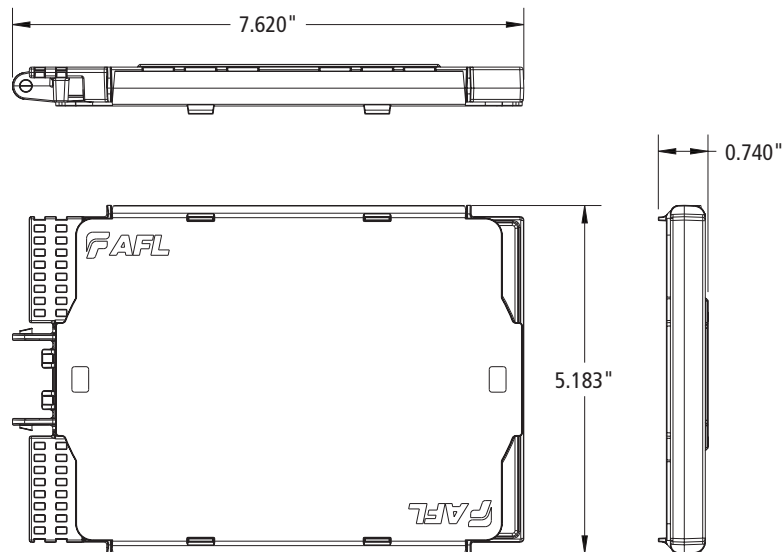

Apex® X-2S Sealed Splice Closure

Installation Kits and Accessories

The AFL Apex closure line has a variety of installation accessories kits to fit many applications. Additional accessories may be available. Contact AFL.



CAU Kit



Ring Clamp Replacement Kit



O-Ring Grease Kit



Wedge Replacement Kit

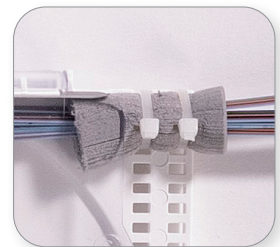

Foam Retention

Ordering Information — Replacement Kits

DESCRIPTION	AFL NO.
REPLACEMENT KITS	
X-2 and X-2S Single Cable Strain Relief/Cable Attachment Unit (CAU) Kit	AX-KIT-CBLSTRN
X-2 and X-2S Dome to Base O-Ring Replacement Kit	AX-KIT-ORING-2
Apex O-Ring Grease, Pack of 10	AX-KIT-GREASE-10
X-2 and X-2S Dome to Base Locking Ring Clamp Replacement Kit	AX-KIT-CLAMP-2
X-2 and X-2S Wedge Replacement Kit	AX-KIT-WEDGE-2
X-2 and X-2S Inner Base Gel Replacement Kit	AX-KIT-GEL-2
X-2S Basket and Yoke Assembly Kit. Can be used in combination with the basket cover.	AX-KIT-BASKET-2S
X-2S Dome Replacement Kit	AX-KIT-DOME-2S
WTC-SWR Bundle Splice Tray Retention Kit - Includes 25 foam grommets for retaining SWR bundles to splice trays	HW000406
Velcro, 75 Foot Length Roll – For securing SWR bundles in the slack basket	FC001759

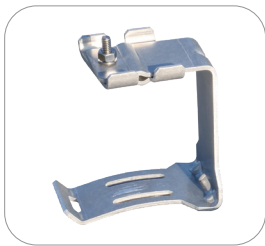

Apex Aerial Hanger Bracket



Apex Pole/Wall Mount



Adjustable Aerial Hanger Bracket

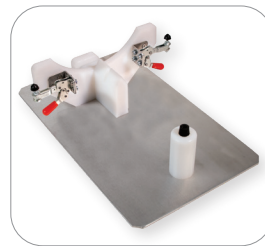

X-2 and X-2S Installation Stand



Universal Installation Stand

Ordering Information — Accessories

DESCRIPTION	AFL NO.
ACCESSORIES	
Aerial strand mount hanger kit	AX-KIT-AERIAL-1
Pole/wall mount kit	AX-BR30
Adjustable Aerial Strand Mount Hanger kit	AX-KIT-AERIAL-ADJ
ADSS Aerial hanger brackets	AX-KIT-AERIAL-ADSS
Multi-Drop Cable Entry Kit (fits up to 4 cables 0.20" to 0.39" in diameter or flat drop cable)	AX-KIT-DROP-4
X-2 and X-2S Installation Stand	FC104649
Apex Universal Installation Stand	AX-KIT-U-STAND

Apex® X-2S Sealed Splice Closure

Installation Accessories (cont.)



Mesh Transition Tubing

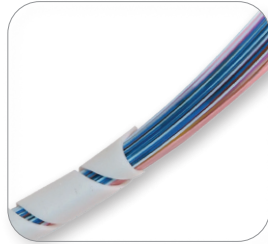

Silicone Spiral Wrap

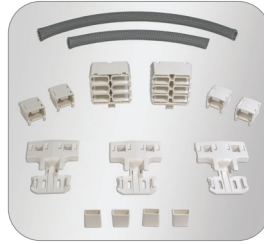

AFRS Kit 1

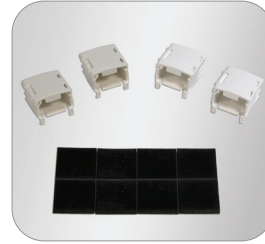

AFRS Kit 2



A-B Tray Adapter Kit

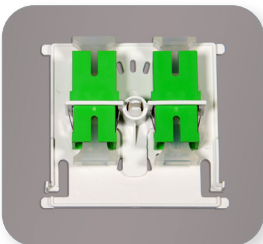

SC Bulkhead Adapter Kit



Replacement Slack Storage Basket Tabs

Ordering Information — Accessories (cont.)

DESCRIPTION	AFL NO.
ACCESSORIES	
1/4" Colored Mesh Transition Tubing, 250' Spool (*Replace "XX" with color per TIA-598 color code - BL, OR, GR, BR, SL, WH, RD, BK, YL, VI, RS or AQ)	AX-KIT-TUBE-014-XX*
Silicone Spiral Wrap, 5.5 Foot Length	FC001657
Apex Cable Bonding Kit (Bonds armored cable sheath to ground) – Pack of 10	AX-KIT-GROUND-10
Apex Internal Multiple Ground Bonding Kit	AX-KIT-GNDLD-5
Apex Advanced Fiber Retention System (AFRS) Kit 1 – Used for Ribbon Cable (Flat Matrix, SWR, Tubed, Central Core). Kit includes: Mesh Basket Adapter (2 ea.), Mesh Housing (2 ea.), Mesh Insert (24 ea.), V-Clips (12 ea.), and Clean Cut Gray Mesh (13 ft.).	AX-KIT-AFRSRBN
Apex AFRS Kit 2 – Used for Loose Tube Cable. Kit includes: V-Clip (24 ea.) and Retention Pads (6 sheets of 8 pads)	AX-KIT-AFRSLT
Apex AFRS Kit 3 – V-Clip bulk kit. Includes: V-Clips (120 ea.) and Mesh Inserts (120 ea.)	AX-KIT-AFRSVC-120
Apex AFRS Kit 4 – Mesh bulk kit. Includes: Clean Cut Gray Mesh (100 ft.)	AX-KIT-AFRSMESH-100FT
Apex AFRS Kit 5 – Mesh Housing bulk kit. Includes: Mesh Basket Adapter (10 ea.) and Mesh Housing (10 ea.)	AX-KIT-AFRSAH-10
Apex AFRS Kit 6 – Mesh Basket Adapter bulk kit. Includes: Mesh Basket Adapter (10 ea.)	AX-KIT-AFRSA-10
Apex Restoration Kit, 1000' of 144F Non-Armored Wrapping Tube Cable (Apex X-2S is in Restoration Kit)	AX-2S-B-L-4-4-4-X-1R1000F
Apex A-B Tray Adapter Kit, 1 Kit of 6 pieces	AX-ADPTR-ABTRAY-6
Apex A-B Tray Adapter Kit, 10 Kits of 6 pieces	AX-ADPTR-ABTRAY-60
Apex Bulkhead Kit with Plate SC/APC Adapters, 1 kit	AX-TRAY-ASC
Apex Bulkhead Kit with Plate with SC/UPC Adapters, 1 kit	AX-TRAY-USC
Apex Bulkhead Kit with Plate SC/APC Adapters, 6 pc kit	AX-TRAY-ASC-6
Apex Bulkhead Kit with Plate SC/UPC Adapters, 6 pc kit	AX-TRAY-USC-6
Apex Replacement Slack Storage Basket Tabs – Pack of 25	AX-KIT-BTAB-25

Apex® X-2S Sealed Splice Closure

Splitter Splice Trays

Passive optical splitters, or PLCs (Planar Lightwave Circuits), can be provided preinstalled into the Apex X-2S splice tray. PLCs can either be installed and splice within the same tray, or provided with a separate dedicated tray for splicing, with fibers routed between trays using protective tubing. A third option provides one additional tray to separate input and output fiber splicing.

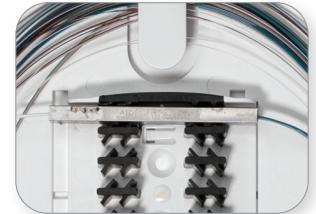
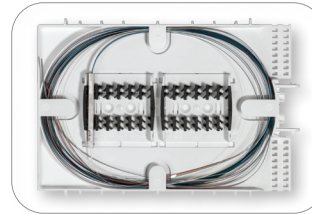

Ordering Information

DESCRIPTION	SPLIT RATIO	AFL NO.
SPLITTER MODULES FOR SPLICE TRAYS		
X-2S Tray with Four Splice Modules, (1) 1x2 PLC Splitter	1x2	AX-TRAY-2S-12-1
X-2S Tray with Two Splice Modules, (1) 1x4 PLC Splitter	1x4	AX-TRAY-2S-14-1
X-2S Tray with Two Splice Modules, (1) 1x8 PLC Splitter	1x8	AX-TRAY-2S-18-1
X-2S Tray with Two Splice Modules, (1) 1x16 PLC Splitter	1x16	AX-TRAY-2S-116-1
X-2S Tray with Two Splice Modules, (1) 1x32 PLC Splitter	1x32	AX-TRAY-2S-132-1
X-2S Tray with (1) 1x2 PLC Splitter and Separate Splicing Tray with Two Splice Modules	1x2	AX-TRAY-2S-12-2
X-2S Tray with (1) 1x4 PLC Splitter and Separate Splicing Tray with Two Splice Modules	1x4	AX-TRAY-2S-14-2
X-2S Tray with (1) 1x8 PLC Splitter and Separate Splicing Tray with Two Splice Modules	1x8	AX-TRAY-2S-18-2
X-2S Tray with (1) 1x16 PLC Splitter and Separate Splicing Tray with Two Splice Modules	1x16	AX-TRAY-2S-116-2
X-2S Tray with (1) 1x32 PLC Splitter and Separate Splicing Tray with Two Splice Modules	1x32	AX-TRAY-2S-132-2
X-2S Tray with (1) 1x2 PLC Splitter and 2 Separate Splicing Trays with Two Splice Modules each	1x2	AX-TRAY-2S-12-3
X-2S Tray with (1) 1x4 PLC Splitter and 2 Separate Splicing Trays with Two Splice Modules each	1x4	AX-TRAY-2S-14-3
X-2S Tray with (1) 1x8 PLC Splitter and 2 Separate Splicing Trays with Two Splice Modules each	1x8	AX-TRAY-2S-18-3
X-2S Tray with (1) 1x16 PLC Splitter and 2 Separate Splicing Trays with Two Splice Modules each	1x16	AX-TRAY-2S-116-3
X-2S Tray with (1) 1x32 PLC Splitter and 2 Separate Splicing Trays with Two Splice Modules each	1x32	AX-TRAY-2S-132-3



Expandable to support various cable diameters



Ease of installation (no tapes, washers, or glue)

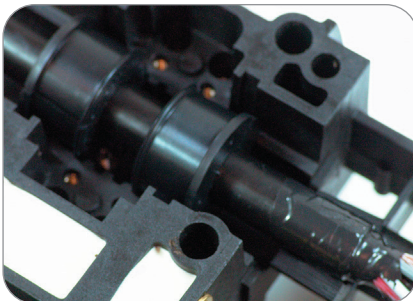

Multiple layers of sealing protection

LightGuard® Peel and Seal Grommet Systems for Sealed Fiber Optic Closures

AFL's cable sealing grommet technology for the LightGuard (LG) Sealed Fiber Optic Closures improves sealing technology utilizing MULTICENTRIC® Grommets that do away with time-consuming tasks such as installing washers and messy sealing tapes for cable entry. MULTICENTRIC Grommets are designed to accept a wide range of cable diameters, eliminating the need to stock a variety of diameter-specific grommet kits.

Conversion kits for old LG-100, LG-200, and LG-300 closures allows for "Peel and Seal" grommet technology to be used without changing out the existing closure.

Features

- All Peel and Seal Grommet Systems support loose tube, core tube, dielectric and armored cable designs
- Installation and re-entry using common hand tools
- Accepts a wide range of cable diameters
- Fast and easy to install
- Fits existing AFL LightGuard sealed closures
- Fully sealed to protect fiber and splices ensuring longevity
- Full conversion kits and dual cable entry port kits



Single



Dual



Quad

Ordering information

SEALED CLOSURE FULL CONVERSION KITS (SINGLE AXIS CABLE ENTRY)

DESCRIPTION	AFL NO.
3 Port Drop Grommet (LG-150/250)	FC000655
Dual Express Grommets for LG-350	FC000337
Quad Express Grommets for LG-350	FC000421
Single Cable Grommet Kit, Drop Port	FC000628
4 Port Drop Grommet (LG-350 / LG-350-AC)	FC000422
LG-350 Express Single Cable Grommet Kit	FC000726
LG-350 Drop Single Cable Grommet Kit	FC000727

Qualifications

GOVERNING BODY	STANDARD CODE
Telcordia	GR-771
Rural Utilities Service (RUS)	515

Contact AFL for further details.

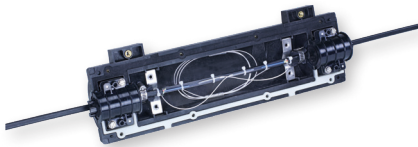
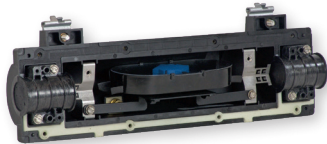
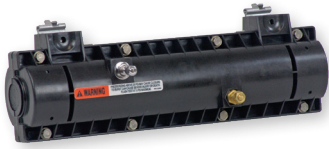

In-line Repair Closure (IRC) for repair of flat or round drop cables

Features

- Accommodates cables to 0.70" O.D for splicing and grounding/bonding
- Incorporates the Peel and Seal Grommet System, fully sealing the closure
- Includes removable, integral central splicing module and individual cable retention clamps
- Requires only a common can wrench for installation

LightGuard® 55 Sealed Fiber Optic Splice Closure

Designed with versatility in mind, the LightGuard (LG) 55 sealed closure from AFL offers a variety of solutions including repair and distribution splicing, grounding for Fiber-in-the-Loop applications, and for use as an isolation gap with armored cables. This closure accepts stranded loose tube or ribbon fiber cables in either armored or dielectric configurations and can be utilized in a butt or in-line configuration.

The LG-55 closure incorporates a unique cable clamp design sealing the cable, allowing both of the cover halves to be removed without disturbing the contents. In addition, AFL's Peel & Seal Grommet System™ is incorporated to ensure a tight fit on various cable diameters, fully sealing the closure and protecting the fiber while eliminating cumbersome tape and washers—making installation fast and easy.

Specifications

PARAMETER	VALUE
Splice Capacity (Max.)—Single, Mass, Mechanical	24, n/a, 24
Number of Splice Trays (Max.)—Single, Mass, Mechanical*	1, n/a, 1
Cable Entrance Configuration	Butt or In-line
Cable Sizes (Min. O.D. - Max. O.D.) Included Grommets Single in. (mm) Double Express Port Only in. (mm)	(2) Express Ports 0.40" - 0.70" (10.0 - 25.4) 0.26" - 0.44" (6.6 - 11.2)
Additional Grommets Quad Express Port Only in. (mm)	0.26" - 0.38" (6.6 - 9.7)
Dimensions—(L x D) in. (mm)	14.0" x 4.0" (343.0 x 101.6)
Weight—lbs. (kg)	3.0 (1.36)

Ordering Information

DESCRIPTION	MODEL NO.	AFL NO.
LG-55 FC000034-PS Fiber Optic Splice Closure—Stores up to 32 single fusion, includes 2 single cable grommets and 1 dual cable grommet kit for sealing/retention and 2 ground terminals. Splice tray and hanger brackets included. Not included: Cable Grounding Kits	LG55-U-1	FC000034-PS
LL-2425 Single Splice Tray—Stores (32) single fusion splices. Maximum of 1 trays in the LG55. Tray Included.	LL-2425	FC000053
LG-350 Single Grommet Kit (Min. 0.40" - Max. 1.00") For use in LG-55 on Express Port side.	LG-350 Exp Single Kit	FC000726
LG-350 Dual Grommet Kit (Min. 0.26" - Max. 0.44") For use in LG-55 on Express Port side.	LG-350 Exp Dual Kit	FC000337
LG-350 Quad Grommet Kit (Min. 0.26" - Max. 0.38") For use in LG-55 on Express Port side.	LG-350 Exp Quad Kit	FC000421
LG-55 Grommet Kit (1) 3 flat drop grommet (flat drop 0.31" or round cable up to 0.25") and (1) dual grommet (Min. 0.26" - Max. 0.44").	LG-55 Drop Kit	FC000807
Cable Grounding Kit (pack of 5)—Clamp-On Ground Cable Only	CGK-5	FC001091
*Mechanical Splice Kit. Includes 10 pieces of VHB tape. Used in all splice trays. Each piece holds 12 splices.	VHB Tape	FA000089

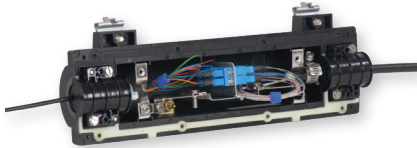

LightGuard® 55-SC Sealed Fiber Optic Splice Closure

AFL's LightGuard (LG) 55-SC sealed closure retains all the features of the LG-55, but includes a unique patching system that utilizes pre-terminated SC fiber assemblies or field-installable connectors such as the FASTConnect® SC.

An innovative solution that can be used to facilitate a link between traffic control cabinets and entrance cables, the LG-55-SC closure allows for rapid restoration and minimal damage to a fiber optic cable should an impact disable the cabinet. A breakable tie wrap secures the pre-connectorized cable to one side of the closure (traffic control cabinet), while the main entrance cable is secured with a more rugged cable clamp, allowing the system to separate during a damaging impact.

Features

- Durable cover assembly that provides protection for all internal components and acts as an interface/anchor to the cable clamps
- Unique cable clamp seal to anchor the cable to the cover assembly
- Movable sheath retention bracket keeps cable bends at a minimum
- Accommodates up to four SC/UPC connectors
- Utilizes AFL's Peel & Seal Grommet System™, ensuring a tight fit on various cable diameters while eliminating cumbersome tape and washers
- Requires only a common can wrench for installation

Specifications

PARAMETER	VALUE
Cable Sizes (Min. O.D. - Max. O.D.)	0.4" - 0.7"
Maximum Cable Entry	2 ports (one each end)
Dimensions - (L x D) in. (mm)	14" x 4" (356.0 mm x 1022.0 mm)

Ordering Information

DESCRIPTION	MODEL NO.	AFL NO.
The LG-55-SC allows for 4 SC connections to be installed. A FASTConnect or FUSEConnect, field installable connectors would be used for the connections. The field side cable is held with a tie-wrap while the signal side is secured to the closure with a hose clamp. This allows for a break-out should a vehicle make contact with a traffic box leaving the signal side cable intact.	LG-55-SC	FC000481-PS
Dual Cable Entry Port Kit – Allows two cables to enter closure from each cable port.	Dual Cable Entry Port Kit	FC000062
Quad Cable Entry Port Kits – Allows 4 cables to enter closure from each cable port	Quad Cable Entry Port Kit	FC000421
Cable Grounding Harness Kit – Includes (5) Clamp-On 9.5" long ground wires AWG #6 conductor	CGK-5	FC001091

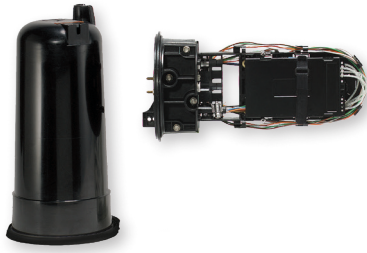

LightGuard® 150 Sealed Fiber Optic Splice Closure

The LightGuard (LG) 150 is a sealed dome closure designed for small count fiber splicing (up to 48 single or 192 mass) in a butt configuration. Utilized in aerial or underground environments where a sealed closure is required, the LG-150 is ideal for express or ring applications and requires only a common can wrench for installation.

Features

- Supports stranded loose tube or ribbon fiber cables in either armored or dielectric configurations
- Installation and re-entry requires only a common can wrench
- Fully sealed to protect fiber and splices ensuring longevity
- Fully kitted with all parts to install five cables
- Designed and tested to Telcordia® GR-771 requirements
- Rural Utilities Service (RUS) Listed

Specifications

PARAMETER	VALUE	
Splice Capacity (Max.)—Single, Mass, Mechanical	48, 192, 48	
Number of Splice Trays (Max.)—Single, Mass, Mechanical*	4, 3, 4	
Cable Entrance Configuration	Butt	
Cables	5	
Cable Sizes (Min. O.D. - Max. O.D.) Included Grommets	(2) Express Ports	(3) Drop Ports
Single in. (mm)	0.26" - 0.62" (6.6 - 15.7)	0.26" - 0.62" (6.6 - 15.7)
Additional Grommets		
(3) Flat Drop Port Only in. (mm)	n/a	0.19" x 0.34" (4.8 x 8.6) or 0.25" round (6.4)
Dimensions—(L x D) in. (mm)	16.25" x 8.75" (412.75 x 222.3)	
Weight—lbs. (kg)	10.5 (4.76)	

LightGuard® 150 Sealed Fiber Optic Splice Closure

Ordering Information

DESCRIPTION	AFL NO.
LG-150-U-0 Fiber Optic Splice Closure—Stores 48 single fusion or 192 mass fusion, includes (5) cable kits for sealing/retention and (2) ground terminals with removable bond. Not included: Splice Trays, Cable Grounding Kits or Hanger Brackets	FC000001-PS
LL-2450 Single Splice Tray—Stores (12) single fusion splices. Maximum of 4 trays in the LG150	91957-00
LL-4850 Mass Splice Tray—Stores (8) mass fusion splices (96 F). Maximum of 4 trays in the LG-150	91958-00
LL-1248 Universal Splice Tray—Stores (12) single fusion splices or (8) mass fusion splices (96 F), or *Mechanical. Max. of 4 trays in the LG-150	911221-00-00
LG-150/250 Single Grommet Kit (Min. 0.26" - Max. 0.62")	FC000704
LG-150/250 3 Flat Drop Grommet Kit (standard flat drop 0.31" or round cable up to 0.25")	FC000655
Universal Aerial Strand Hanger Kit—For use with LG-150/250/350	FC000006
Extended Offset Strand Hanger Kit—For use with LG-150/250/350	FC000208
Pole or Wall Mount Bracket—For use with LG-150/250/350	LGBR-30
OPGW Dual Cable Bracket Kit for use only when installing closure on OPGW cable—For use with LG-150/250/350	FC000683
OPGW Quad Cable Bracket Kit—For use with LG-150/250	FC000746
1x6 Fiber Router Kit with furcation tubes	FC000070
CGK-5 Cable Grounding Kit (pack of 5)—Clamp-On Ground Cable Only	FC001091
*Mechanical Splice Kit. Includes 10 pieces of VHB tape. Used in all splice trays. Each piece holds 12 splices.	FA000089
O-Ring and Lock Ring Kit—For use with LG-150/250	FC000771

* See Accessory Specifications.
See Splice Tray Specifications.

Qualifications

GOVERNING BODY	STANDARD CODE
Telcordia	GR-771
Rural Utilities Service (RUS)	Listed

Contact AFL for further details.

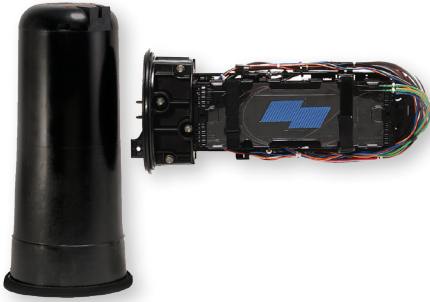

LightGuard® 250 Sealed Fiber Optic Splice Closure

The LightGuard (LG) 250 is a sealed dome closure designed for medium count fiber splicing (up to 144 single or 432 mass) in a butt configuration. Utilized in aerial or underground environments where a sealed closure is required, the LG-250 is ideal for express or ring applications and requires only a common can wrench for installation.

Features

- Supports stranded loose tube or ribbon fiber cables in either armored or dielectric configurations
- Installation and re-entry requires only a common can wrench
- Fully sealed to protect fiber and splices ensuring longevity
- Fully kitted with all parts to install five cables

Specifications

PARAMETER	VALUE	
Splice Capacity (Max.)—Single, Mass, Mechanical	144, 432, 48	
Number of Splice Trays (Max.)—Single, Mass, Mechanical*	4, 3, 4	
Cable Entrance Configuration	Butt	
Cables	5	
Cable Sizes (Min. O.D. - Max. O.D.)		
Included Grommets Single in. (mm)	(2) Express Ports 0.26" - 0.62" (6.6 - 15.7)	(3) Drop Ports 0.26" - 0.62" (6.6 - 15.7)
Additional Grommets (3) Flat Drop Port Only in. (mm)	n/a	0.19" x 0.34" (4.8 x 8.6) or 0.25" round (6.4)
Dimensions—(L x D) in. (mm)	19.0" x 8.75" (482.6 x 222.3)	
Weight—lbs. (kg)	10.5 (4.76)	

continued
→

LightGuard® 250 Sealed Fiber Optic Splice Closure

Ordering Information

DESCRIPTION	AFL NO.
LG-250-U-0 Fiber Optic Splice Closure—Stores 144 single fusion or 432 mass fusion, includes (5) cable kits for sealing/retention and (2) ground terminals with removable bond. Not included: Splice Trays, Cable Grounding Kits or Hanger Brackets	FC000002-PS
LL-2400 Single Splice Tray—Stores (24) single fusion splices. Maximum of 4 trays in the LG-250.	91710-06
LL-2448 Universal Splice Tray—Stores (24) single fusion or (4) mass fusion splices (48 F). Maximum of 3 trays in the LG-250	911289-00-02
LL-4848 Mass Splice Tray—Stores (12) mass fusion splices (144 F). Maximum of 3 trays in the LG-250	911437-00-02
LL-2448-48S Single Splice Tray—Stores (48) single fusion splices. Maximum of 3 trays in the LG-250	FA000045
LG-150/250 Single Grommet Kit (Min. 0.26" - Max. 0.62")	FC000704
LG-150/250 3 Flat Drop Grommet Kit (standard flat drop 0.31" or round cable up to 0.25")	FC000655
Universal Aerial Strand Hanger Kit—For use with LG-150/250/350	FC000006
Extended Offset Strand Hanger Kit—For use with LG-150/250/350	FC000208
PWK Pole or Wall Mount Bracket—For use with LG-150/250/350	LGBR-30
OPGW Dual Cable Bracket Kit—For use with LG-150/250/350	FC000683
OPGW Quad Cable Bracket Kit—For use with LG-150/250	FC000746
1x6 Fiber Router Kit with furcation tubes	FC000070
CGK-5 Cable Grounding Kit (pack of 5)—Clamp-On Ground Cable Only	FC001091
*Mechanical Splice Kit. Includes 10 pieces of VHB tape. Used in all splice trays. Each piece holds 12 splices.	FA000089
O-Ring and Lock Ring Kit—For use with LG-150/2	FC000771

* See Accessory Specifications.
See Splice Tray Specifications.

Qualifications

GOVERNING BODY	STANDARD CODE
Telcordia	GR-771
Rural Utilities Service (RUS)	Listed

Contact AFL for further details.

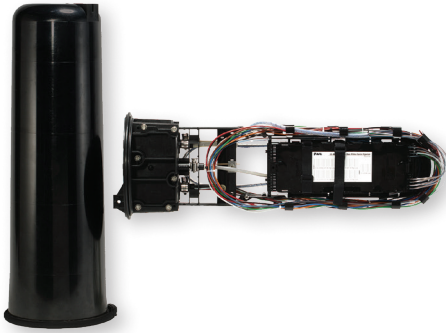

LightGuard® 350 Sealed Fiber Optic Splice Closure

The LightGuard (LG) 350 is a sealed dome closure designed for large count fiber splicing (up to 480 single or 1152 mass) in a butt configuration. Utilized in aerial or underground environments where a sealed closure is required, the LG-350 is ideal for express, ring or long haul applications and requires only a common can wrench for installation.

Features

- Supports stranded loose tube or ribbon fiber cables in either armored or dielectric configurations
- Installation and re-entry requires only a common can wrench
- Fully sealed to protect fiber and splices ensuring longevity
- Fully kitted with all parts to install five cables

Specifications

PARAMETER	VALUE	
Splice Capacity (Max.)—Single, Mass, Mechanical	480, 1152, 108	
Number of Splice Trays (Max.)—Single, Mass, Mechanical*	12, 8, 8	
Cable Entrance Configuration	Butt	
Cables	5 to 11	
Cable Sizes (Min. O.D. - Max. O.D.)	(2) Express Ports	(3) Drop Ports
Included Grommets	0.40" - 1.00"	0.26" - 0.80"
Single in. (mm)	(10.0 - 25.4)	(6.6 - 20.0)
Additional Grommets	0.26" - 0.44"	
Dual Express Port Only in. (mm)	(6.6 - 11.2)	
Quad Express Port Only in. (mm)	0.26" - 0.38"	
	(6.6 - 9.7)	
(4) Flat Drop Port Only in. (mm)		0.19" x 0.34"
		(4.8 x 8.6) or
		0.25" round (6.4)
Dimensions—(L x D) in. (mm)	28.0" x 10.0" (710.0 x 254.0)	
Weight - lbs. (kg)	16 (7.26)	

continued
→

LightGuard® 350 Sealed Fiber Optic Splice Closure

Ordering Information

DESCRIPTION	AFL NO.
LG-350-U-0 Fiber Optic Splice Closure – Stores 480 single fusion or 1152 mass fusion, includes (5) cable kits for sealing/retention and (2) ground terminals with removable bond. Not included: Splice Trays, Cable Grounding Kits or Hanger Brackets	FC000009-PS
LL-2400 Single Splice Tray – Stores (24) single fusion splices. Maximum of 12 trays in the LG-350	91710-06
LL-2448 Universal Splice Tray – Stores (24) single fusion or (4) mass fusion splices (48 F). Maximum of 8 trays in the LG-350	911289-00-02
LL-4848 Mass Splice Tray – Stores (12) mass fusion splices (144 F). Maximum of 8 trays in the LG-350	911437-00-02
LL-2448-48S Single Splice Tray – Stores (48) single fusion splices. Maximum of 8 trays in the LG-350	FA000045
LL-4896 Universal Splice Tray – Stores (96) single fusion splices or (24) mass fusion splices (288 F). Maximum of 5 trays in the LG-350	911676-00-02
LL-4896-R Mass Splice Tray – Stores (24) mass fusion splices (288 F). Maximum of 5 trays in the LG-350	FA000022
LL-4896-L Single Splice Tray – Stores (96) single fusion splices. Maximum of 5 trays in the LG-350	FA000023
LL-7644 Universal Splice Tray – Stores (60) single fusion or (288) mass fusion splices or a combination of both in an easy-to-use, deep splice tray. For use with LG-350SD	FA000044
LL-7060 Splice Tray – Stores (60) single fusion splices in an easy-to-use, deep splice tray – For use in LG-350	FA000042
LL-7144 Splice Tray – Stores (288) mass fusion splices in an easy-to-use, deep splice tray – For use in LG-350	FA000043
LG-350 Single Grommet Kit (Min. 0.40" - Max. 1.00") – For use in LG-350/AC/SD on Express Port side	FC000726
LG-350 Dual Grommet Kit (Min. 0.26" - Max. 0.44") – For use in LG-350/AC/SD on Express Port side	FC000337
LG-350 Quad Grommet Kit (Min. 0.26" - Max. 0.38") – For use in LG-350/AC/SD on Express Port side	FC000421
LG-350 Single Grommet Kit (Min. 0.26" - Max. 0.80") – For use in LG-350/AC/SD on Drop Port side	FC000727
LG-350 Drop 4 Flat Drop Grommet Kit – For use with standard flat drop cable and round cable up to 0.25" O.D.	FC000422
Universal Aerial Strand Hanger Kit – For use with LG-150/250/350	FC000006
Extended Offset Strand Hanger Kit – For use with LG-150/250/350	FC000208
PWK Pole or Wall Mount Bracket – For use with LG-150/250/350	LGBR-30
OPGW Dual Cable Bracket Kit – For use with LG-150/250/350	FC000683
OPGW Quad Cable Bracket Kit for use when installing Sealed Closures – For use with LG-350	FC000747
1x6 Fiber Router Kit with furcation tubes	FC000070
CGK-5 Cable Grounding Kit (pack of 5) – Clamp-On Ground Cable Only	FC001091
*Mechanical Splice Kit. Includes 10 pieces of VHB tape. Used in all splice trays. Each piece holds 12 splices.	FA000089
O-Ring and Lock Ring Kit – For use with LG-350/350AC/SD	FC000775

* See Accessory Specifications. See Splice Tray Specifications.
Micro Duct Grommets available. Please call Customer Service for details.

Qualifications

GOVERNING BODY	STANDARD CODE
Telcordia	GR-771
Rural Utilities Service (RUS)	Listed

Contact AFL for further details.

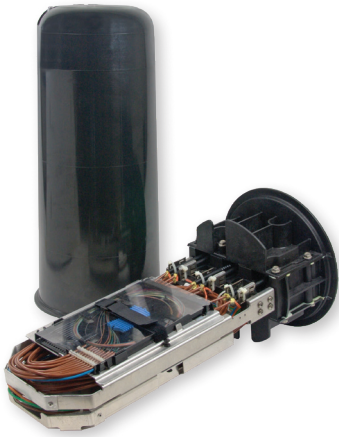

LightGuard® 350-AC Drop Access Sealed Fiber Optic Splice Closure

The LightGuard (LG) 350-AC is a sealed dome closure designed for medium count fiber splicing (up to 144 single or 432 mass) in a butt configuration where space may be limited. Utilized in aerial or underground environments where a sealed closure is required, the LG-350-AC is designed for “drop access” applications providing access for up to 12 drops. The LG-350-AC is ideal for Fiber-to-the-Home installations in small hand-hole application and requires only a common can wrench for installation.

Features

- Less than 20" overall length; ideal for small hand-holes
- Supports stranded loose tube or ribbon fiber cables in either armored or dielectric configurations
- Installation and re-entry requires only a common can wrench
- Fully sealed to protect fiber and splices ensuring longevity
- Fully kitted with all parts to install two cables and up to 12 drops

Specifications

PARAMETER	VALUE	
Splice Capacity (Max.)—Single, Mass, Mechanical	144, 432, 48	
Number of Splice Trays (Max.) - Single , Mass, Mechanical*	4, 3, 4	
Cable Entrance Configuration	Butt	
Cables	2 to 8 Express with up to 12 Drop	
Cable Sizes (Min. O.D. - Max. O.D.)	(2) Express Ports	(3) Drop Ports
Included Grommets	0.40" - 1.00"	(4 port) 0.26" - 0.80"
Single in. (mm)	(10.0 - 25.4)	
(4) Flat Drop Only in. (mm)		(6.6 - 20.0)
Additional Grommets		
Dual Express Port Only in. (mm)	0.26" - 0.44"	
	(6.6 - 11.2)	
Quad Express Port Only in. (mm)	0.26" - 0.38"	
	(6.6 - 9.7)	
(4) Flat Drop Port Only in. (mm)		0.19" x 0.34"
		(4.8 x 8.6) or
		0.25" round (6.4)
Dimensions - (L x D) in. (mm)	19.8" x 10.0" (503.0 x 254.0)	
Weight - lbs. (kg)	12.0 (5.44)	

continued
→

LightGuard® 350-AC Drop Access Sealed Fiber Optic Splice Closure

Ordering Information

DESCRIPTION	AFL NO.
LG-350-AC Fiber Optic Splice Closure—Stores 144 single fusion or 432 mass fusion, includes (2) Express cable kits and (12) Drop cable kits for sealing/retention and (2) ground terminals with removable bond. Included: (1) LL-4808L Splice Tray Not included: Cable Grounding Kits, or Hanger Brackets	FC000412
LL-4808L-R Universal Splice Tray—Stores (36) single fusion splices or (12) mass fusion splices (144 F). Maximum of 4 trays in the LG-350-AC.	FA000037
LL-4808-R Mass Splice Tray—Stores (12) mass fusion splices (144 F). Maximum of 4 trays in the LG-350-AC	FA000020
LL-4808-L Single Splice Tray—Stores (36) single fusion splices. Maximum of 4 trays in the LG-350-AC	FA000021
LG-350 Single Grommet Kit (Min. 0.40" - Max. 1.00")—For use in LG-55/LG-350/LG-350-AC on Express Port side	FC000726
LG-350 Dual Grommet Kit (Min. 0.26" - Max. 0.44")—For use in LG-55/LG-350/LG-350-AC on Express Port side	FC000337
LG-350 Quad Grommet Kit (Min. 0.26" - Max. 0.38")—For use in LG-55/LG-350/LG-350-AC on Express Port side	FC000421
LG-350 Single Grommet Kit (Min. 0.26" - Max. 0.80")—For use in LG-350/AC/SD on Drop Port side	FC000727
LG-350 Drop 4 Flat Drop Grommet Kit—For use with standard flat drop cable and round cable up to 0.25" O.D.	FC000422
Universal Aerial Strand Hanger Kit—For use with LG-150/250/350	FC000006
Extended Offset Strand Hanger Kit—For use with LG-150/250/350	FC000208
PWK Pole or Wall Mount Bracket—For use with LG-150/250/350	LGBR-30
OPGW Dual Cable Bracket Kit—For use with LG-150/250/350	FC000683
1x6 Fiber Router Kit with furcation tubes	FC000070
CGK-5 Cable Grounding Kit (pack of 5)—Clamp-On Ground Cable Only	FC001091
*Mechanical Splice Kit. Includes 10 pieces of VHB tape. Used in all splice trays. Each piece holds 12 splices.	FA000089
LG-350 O-Ring and Lock Ring Kit—For use with LG-350/AC/SD	FC000775

* See Accessory Specifications.
See Splice Tray Specifications.

Qualifications

GOVERNING BODY	STANDARD CODE
Telcordia	GR-771
Rural Utilities Service (RUS)	Listed

Contact AFL for further details.

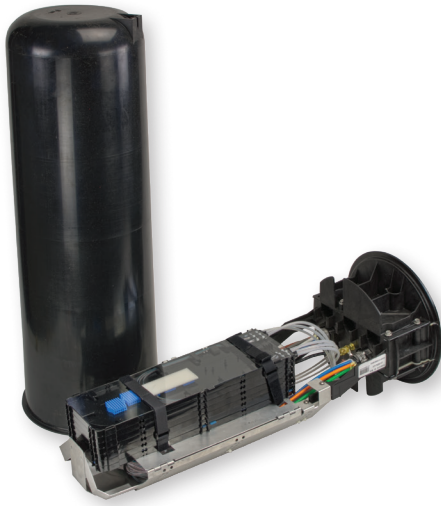

LightGuard® 350XL Sealed Fiber Optic Splice Closure

The LightGuard (LG) 350XL is a sealed dome closure designed for large count fiber splicing (up to 864 single or 2592 mass) in a butt configuration. Utilized in aerial or underground environments where a sealed closure is required, the LG-350XL is ideal for high fiber count splicing and requires only a common can wrench for installation. A Phillips head screw is used to secure the tray support to the basket.

Features

- Supports stranded loose tube or ribbon fiber cables in either armored or dielectric configurations
- Installation and re-entry requires only a common can wrench
- Fully sealed to protect fiber and splices ensuring longevity
- Fully kitted with all parts to install five cables
- Accommodates up to 7 cables
- Oversized basket allows multiple configurations of slack storage
- O-Ring and Locking Ring for increased protection

Specifications

PARAMETER	VALUE	
Splice Capacity (Max.)—Single, Mass, Mechanical	864, 2592, 288	
Number of Splice Trays (Max.)—Single, Mass, Mechanical*	9, 9, 9	
Cable Entrance Configuration	Butt	
Cables	5 to 7	
Cable Sizes (Min. O.D. - Max. O.D.)	(2) Express Ports	(3) Drop Ports
Included Grommets	0.40" - 1.18"	0.30" - 1.08"
Single in. (mm)	(10.0 - 30.0)	(7.6 - 27.4)
Additional Grommets	0.38" - 0.56"	
Dual Exp. Port Only in. (mm)	(9.7 - 14.2)	
Dimensions - (L x D) in. (mm)	31.0" x 12.00" (788.5 x 305.0)	
Weight - lbs. (kg)	25.0 (11.3)	

continued
→

LightGuard® 350XL Sealed Fiber Optic Splice Closure

Ordering Information

DESCRIPTION	AFL NO.
LG-350XL-U-0 Fiber Optic Splice Closure – Stores 864 single fusion or 2592 mass fusion, includes (5) cable kits for sealing/retention and (2) ground terminals with removable bond. Not included: Splice Trays, Cable Grounding Kits or Hanger Brackets	FC000010-PS
LL-4896 Universal Splice Tray – Stores (96) single fusion splices or (24) mass fusion splices (288 F), *Mechanical. Max. of 9 trays in the LG-350XL	911676-00-02
LL-4896-R Mass Splice Tray – Stores (24) mass fusion splices (288 F). Max. of 9 trays in the LG-350XL	FA000022
LL-4896-L Single Splice Tray – Stores (96) single fusion splices. Max. of 9 trays in the LG-350XL	FA000023
LG-350XL Single Grommet Kit (Min. 0.40" - Max. 1.18") – For use in LG-350XL on Express Port side	FC000870
LG-350XL Dual Grommet Kit (Min. 0.38" - Max. 0.56") – For use in LG-350XL on Express Port side	FC000688
LG-350XL Single Grommet Kit (Min. 0.30" - Max. 1.08") – For use in LG-350XL on Drop Port side	FC000871
LG-350XL Drop 4 Flat Drop Grommet Kit – For use with standard flat drop cable and round cable up to 0.25" O.D.	FC001713
Strand Mount Hanger Bracket – For use with LG-350XL in strand or vault mounting	912215-00-00
1x6 Fiber Router Kit with furcation tubes	FC000070
CGK-5 Cable Grounding Kit (pack of 5) – Clamp-On Ground Cable Only	FC001091
*Mechanical Splice Kit. Includes 10 pieces of VHB tape. Used in all splice trays. Each piece holds 12 splices.	FA000089
O-Ring and Lock Ring Kit – For use with LG-350XL	FC001328
Transition tubing 16.25" long – Used to transport ribbon to the splice trays. (20) per kit	FC001372

* See LL-4896 Splice Tray Specifications.

Qualifications

GOVERNING BODY	STANDARD CODE
Telcordia	GR-771
Rural Utilities Service (RUS)	Listed

Contact AFL for further details.



LightGuard® Aerial Weathertight Fiber Optic Splice Closures

The AFL family of Aerial Weathertight Splice Closures is designed to provide a cost-effective solution for your aerial splicing needs. Quality engineering reduces the installation time, training and complexity associated with fiber splicing in the field. The closures have all been designed to be installed without the need for special tools, heat, adhesives, drills or any powered equipment. Durable and easy to install, these closures will improve productivity, reduce labor expenses and last the life of the plant.

Features

- Individual, patented, self-sizing cable grommets and strength member tie downs provide for cable additions without disturbing those previously installed
- Unique tongue-in-groove closure seal and back-to-back grommet design provides for a weathertight and insect seal
- Closures are re-enterable without the need for any re-entry kits and require only a common can wrench for installation

Specifications

PARAMETER	LG-410-U-0	LG-420-U-0	LG-500-U-0	LG-600-U-0
Splice Capacity (Max.) – Single, Mass, Mechanical	144, 432, 36	12, 48, 12	144, 432, 36	384, 1152, 96
Splice Tray Capacity – Single, Mass	4, 2	n/a, n/a	4, 2	12, 8, 8
Cable Ports	4-8	4-6	4-8	6 (3 per end)
Cable Entrance	In-line, Butt	In-line (taut sheath)	In-line, Butt	In-line, Butt
Cable Sizes (O.D.)	4 @ 0.3-0.82" Up to 8 with Dual Grommet Kits 4 @ 0.27-0.53" 4 @ 0.38-0.70"	4 @ 0.3-0.82" Up to 6 with Dual Grommet Kits 2 @ 0.27-0.53" 2 @ 0.38-0.70"	4 @ 0.3-0.82" Up to 8 with Dual Grommet Kits 4 @ 0.27-0.53" 4 @ 0.38-0.70"	6 @ 0.44 - 1.0" Up to 12 with Dual Grommet Kits 6 @ 0.4-0.6" 6 @ 0.7-0.9"
CLOSURE TEST ^{1,2}				
- Cable Retention (100 lbs.)	Passed	Passed	Passed	Passed
- Impact Resistance (0-40 °C)	Passed	Passed	Passed	Passed
- Chemical Resistance	Passed	Passed	Passed	Passed
- Cable Flexing	Passed	Passed	Passed	Passed
- Dust (Weather Tightness)	Passed	Passed	Passed	Passed
- Driving Rain	Passed	Passed	Passed	Passed
- Rodent Test	Passed	Passed	Passed	Passed
Dimensions (L x W x D) in. (cm)	36.00 x 8.00 x 4.00 (91.44 x 20.32 x 10.16)	36.00 x 8.00 x 4.00 (91.44 x 20.32 x 10.16)	27.00 x 8.25 x 4.00 (68.58 x 20.96 x 10.16)	27.00 x 11.25 x 7.50 (68.58 x 28.58 x 19.05)
Weight lbs. (kg)	8.5 (3.86)	8.5 (3.86)	6.4 (2.90)	18 (8.16)

- NOTES:**
1. Tested to Telcordia GR-771-Core and Aerial Strand requirements
 2. Not all Telcordia tests are listed due to space constraints; All closures are designed and tested to appropriate aerial test requirements

Qualifications

GOVERNING BODY	STANDARD CODE
Telcordia	GR-771
Rural Utilities Service (RUS)	Listed

Contact AFL for further details.

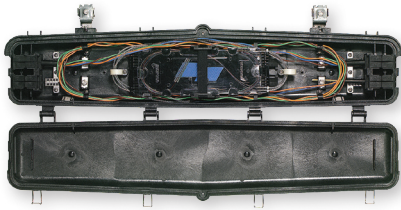

LightGuard® 410 Aerial Weathertight Fiber Optic Splice Closure

The LightGuard (LG) 410 Aerial Weathertight Fiber Optic Splice Closure is designed for medium count fiber splicing (up to 144 single or 432 mass) in a butt or in-line configuration. Utilized in aerial applications, the LG-410 provides additional fiber bundle storage with its extended length design and requires only a common can wrench for installation.

Features

- Four individual, self-sizing grommeted cable ports (expandable to eight cable entrances)
- Patented tongue-in-groove cover seal system
- Installation and re-entry only require a common can wrench
- Cable retention clamps provide pullout
- UV-resistant engineered thermoplastic

Specifications

PARAMETER	VALUE
Splice Capacity (Max.) – Single, Mass, Mechanical	144/432/36
Number of Splice Trays (Max.) – Single, Mass, Mechanical*	4, 3, 4
Cable Entrance Configuration	Butt or in-line
Cables	4 to 8
Cable Sizes (Min. O.D. - Max. O.D.) Included Grommets Single in. (mm) Additional Grommets Dual Grommet in. (mm) 6-port Multi-Drop Grommet in. (mm)	(4) Cable Ports 4 @ 0.38" - 0.82" (7.6 - 20.8) Sm: 0.27" - 0.53" (6.9 - 13.5) Lg: 0.38" - 0.70" (9.5 - 17.8) 0.20" - 0.37" (5.1 - 9.4)
Dimensions – (L x D) in. (mm)	36.00" x 8.0" x 4.0" (914.0 x 203.0 x 102.0)
Weight – lbs. (kg)	8.5 (3.81)

continued
→

LightGuard® 410 Aerial Weathertight Fiber Optic Splice Closure

Ordering Information

DESCRIPTION	MODEL NO.	AFL NO.
LG-410 Aerial Weathertight Fiber Optic Splice Closure – Stores 144 single fusion or 432 mass fusion, includes (4) cable kits for sealing/retention and (2) ground terminals with removable bond, and hanger brackets. Not included: Splice Trays or Cable Grounding Kits	LG-410-U-0	FC000022
LL-2400 Single Splice Tray – Stores (24) single fusion splices. Maximum of 4 trays in the LG-410.	LL-2400	91710-06
LL-2448 Universal Splice Tray – Stores (24) single fusion or (4) mass fusion splices (48 F). Maximum of 3 trays in the LG-410.	LL-2448	911289-00-02
LL-4848 Mass Splice Tray – Stores (12) mass fusion splices (144 F). Maximum of 3 trays in the LG-410.	LL-4848	911437-00-02
LL-2448-48S Single Splice Tray – Stores (48) single fusion splices. Maximum of 3 trays in the LG-410.	LL-2448-48S	FA000045
Small Single Grommet Kit (10 pc grommet only) – (Min 0.38" - Max 0.82")	Small Single Grommet Kit (10)	911496-00-00
Small Dual Grommet Kit – Includes: (2) small dual grommets and hardware (Min 0.27" - Max 0.53" and Min 0.38" - Max 0.70")	Small Dual Grommet Kit	911386-00-01
Small Dual Grommet Kit (10 pc grommet only) – (Min 0.27" - Max 0.53" and Min 0.38" - Max 0.70")	Small Dual Grommet Kit (10)	911495-00-00
Small 6-Port Drop Cable Kit – 2 grommets with tie wrap and foam Allows six cable entries (Min 0.20" - Max 0.365" and flat drop)	Small 6 Port Drop Kit	FC000573
Large Single Grommet Kit with retention hardware (Min 0.44" - Max 1.04")	Large Single Grommet Kit	FC000623
Small 6-Port Drop Cable Kit (10 pc grommet only) (Min 0.20" - Max 0.365" and flat drop)	Small Drop Grommet Kit (10)	FC000644
Large Single Grommet Kit (10 pc grommet only) (Min 0.44" - Max 1.04")	Large Single Grommet Kit (10)	91918-00
Large Dual Grommet Expansion Kit—Includes: (2) Dual grommets and hardware (Min .40"-Max .70" and Min 0.60" - Max 0.90")	Large Dual Grommet Kit	911406-00-00
Large 6 Port Drop Cable Kit—2 Grommets with retention bracket. Allows six cable entries (Min 0.23" - Max 0.48" and flat drop)	Large 6 Port Drop Kit	FC000352
Adjustable Aerial Hanger Kit Bracket Kit (included with closure)	Adjustable Hanger LG-400/500/600	911497-00-00
Extended Offset Aerial Hanger Kit LG-400/500/600	Offset Hanger LG-400/500/600	91990-00
Retention hardware for additional cables or replacement hardware—LG-400/500/600 (no grommets)	Cable Retention Kit LG-400\500\600	FC000356
Closure Extension Kit - Used to join multiple closures for extended sheath openings required to repair cable sheath and damaged fibers	Closure Extension Kit LG-400/500/600	911499-00-00
1x6 Fiber Router Kit with furcation tubes.	1x6 Fiber Router	FC000070
Cable Grounding Kit (pack of 5)—Clamp-On Ground Cable Only	CGK-5	FC001091
*Mechanical Splice Kit. Includes 10 pieces of VHB tape. Used in all splice trays. Each piece holds 12 splices.	VHB Tape	FA000089

* See Accessory Specifications. See Splice Tray Specifications.

Qualifications

GOVERNING BODY	STANDARD CODE
Telcordia	GR-771
Rural Utilities Service (RUS)	Listed

Contact AFL for further details.

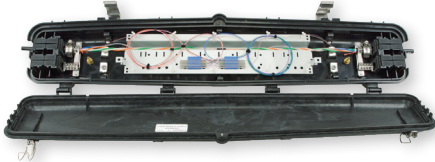

LightGuard® 420 Aerial Weathertight Fiber Optic Splice Closure

The LightGuard (LG) 420 Aerial Weathertight Fiber Optic Splice Closure is designed for taut sheath (no slack) splicing (up to 24 single or 48 mass) in an in-line configuration. Utilized in aerial applications, the LG-420 is ideal for repairing cable sheath or fibers, providing mid-span access and requires only a common can wrench for installation.

Features

- Four individual, self-sizing grommets cable ports (expandable to eight cable entrances)
- Taut Sheath splice module accommodates up to 12 fusion splices
- Protective channel allowing taut fibers or bundles to pass through the closure
- Patented tongue-in-groove cover seal system
- Installation and re-entry only require a common can wrench
- Cable retention clamps provide pullout
- UV-resistant engineered thermoplastic

Specifications

PARAMETER	VALUE
Splice Capacity (Max.) – Single, Mass, Mechanical	24, 48, 12
Number of Splice Trays (Max.) – Single, Mass, Mechanical*	Splice chips for 24F single fusion splice (incl.)
Cable Entrance Configuration	In-line (taut sheath)
Cables	4 to 8
Cable Sizes (Min. O.D. - Max. O.D.) Included Grommets Single in. (mm) Additional Grommets Dual Grommet in. (mm)	(4) Cable Ports 4 @ 0.38" - 0.82" (7.6 - 20.8) Sm: 0.27" - 0.53" (6.9 - 13.5) Lg: 0.38" - 0.70" (9.5 - 17.8)
6-port Multi-Drop Grommet in. (mm)	0.20" - 0.37" (5.1 - 9.4)
Dimensions – (L x D) in. (mm)	36.0" x 8.0" x 4.0" (914.0 x 203.0 x 102.0)
Weight – lbs. (kg)	8.5 (3.81)

continued
→

LightGuard® 420 Aerial Weathertight Fiber Optic Splice Closure

Ordering Information

DESCRIPTION	MODEL NO.	AFL NO.
LG-420 Aerial Weathertight Fiber Optic Splice Closure – Stores 12 single fusion or 48 mass fusion, includes (4) cable kits for sealing/retention and (2) ground terminals with removable bond, splice chips and hanger brackets. Not included: Cable Grounding Kits	LG-420-U-0	FC000023
Small Single Grommet Kit (10 pc grommet only) (Min 0.38" - Max 0.82")	Small Single Grommet Kit (10)	911496-00-00
Small Dual Grommet Kit – Includes: (2) small dual grommets and hardware (Min 0.27" - Max 0.53" and Min 0.38 - Max 0.70")	Small Dual Grommet Kit	911386-00-01
Small Dual Grommet Kit (10 pc grommet only) (Min 0.27" - Max 0.53" and Min 0.38 - Max 0.70")	Small Dual Grommet Kit (10)	911495-00-00
Small 6-Port Drop Cable Kit – 2 grommets with tie wrap and foam. Allows six cable entries (Min 0.20" - Max 0.365" and flat drop)	Small 6 Port Drop Kit	FC000644
Adjustable Aerial Hanger Kit Bracket Kit (included with closure)	Adjustable Hanger LG-400/500/600	911497-00-00
Extended Offset Aerial Hanger Kit LG-400/500/600	Offset Hanger LG-400/500/600	91990-00
Retention hardware for additional cables or replacement hardware – LG-400/500/600 (no grommets)	Cable Retention Kit LG-400/500/600	FC000356
Closure Extension Kit – Used to join multiple closures for extended sheath openings required to repair cable sheath and damaged fibers	Closure Extension Kit LG-400/500/600	911499-00-00
1x6 Fiber Router Kit with furcation tubes	1x6 Fiber Router	FC000070
Cable Grounding Kit (pack of 5) – Clamp-On Ground Cable Only	CGK-5	FC001091
*Mechanical Splice Kit. Includes 10 pieces of VHB tape. Used in all splice trays. Each piece holds 12 splices.	VHB Tape	FA000089

* See Accessory Specifications. See Splice Tray Specifications.

Qualifications

GOVERNING BODY	STANDARD CODE
Telcordia	GR-771
Rural Utilities Service (RUS)	Listed

Contact AFL for further details.



LightGuard® 420 FTTx Aerial Weathertight Fiber Optic Splice Closure

The LightGuard (LG) 420 FTTx Aerial Weathertight Fiber Optic Splice Closure is designed for taut sheath (no slack) splicing (up to 32 single) in an in-line configuration. Utilized in aerial applications, the LG-420-FTTx is ideal for FTTx access networks by providing access for up to 12 drop cables and 16 connections, requiring only a common can wrench for installation.

Features

- Four individual, self-sizing grommeted cable ports:
 - 2 express ports
 - 2 multi-drop ports
- 12 drop cables and 16 connections
- Special multi-drop grommet and cable retention
- Special lock-out interior enclosure
- Patented tongue-in-groove cover seal system
- Installation and re-entry only require a common can wrench
- Cable retention clamps provide pullout
- UV resistant engineered thermoplastic

Specifications

PARAMETER	VALUE
Splice Capacity (Max.) – Single, Mass, Mechanical	32, n/a, 12
Number of Splice Trays (Max.) – Single, Mass, Mechanical*	1, n/a, 1
Cable Entrance Configuration	In-line (taut sheath)
Cables	2 to 4 Express with up to 12 Drop
Cable Sizes (Min. O.D. - Max. O.D.) Included Grommets	(4) Cable Ports
Single in. (mm)	2 @ 0.38" - 0.82" (7.6 - 20.8)
6-port Multi-Drop Grommet in. (mm)	2 (6 port) @ 0.20" - 0.37" (5.1 - 9.4)
Additional Grommets	
Dual Grommet in. (mm)	Sm: 0.27" - 0.53" (6.9 - 13.5)
	Lg: 0.38" - 0.70" (9.5 - 17.8)
6-port Multi-Drop Grommet in. (mm)	0.20" - 0.37" (5.1 - 9.4)
Dimensions – (L x D) in. (mm)	36.0" x 8.0" x 4.0" (914.0 x 203.0 x 102.0)
Weight – lbs. (kg)	8.5 (3.81)

continued
→

LightGuard® 420 FTTx Aerial Weathertight Fiber Optic Splice Closure

Ordering Information

DESCRIPTION	MODEL NO.	AFL NO.
The AFL LightGuard (LG) 420 FTTx Aerial Weathertight Fiber Optic Splice Closures are designed to allow taut sheath (no slack) or conventional splicing in aerial applications such as FTTx access networks. The LG-420 FTTx provides access for 1 to 16 connections and up to 12 subscriber drops and requires only a common can wrench for installation. Includes: Hanger Brackets and Splice Tray. Not included: Cable Grounding Kits.	LG-420-U-FTTx	FC000099
LL-2425 Single Splice Tray – Stores (32) single fusion splices. Maximum of 1 tray in the LG-420-FTTx.	LL-2425	FC000053
Small Single Grommet Kit of (10 pc grommet only) – (Min .38" - Max .82")	Small Single Grommet Kit (10)	911496-00-00
Small Dual Grommet Kit – Includes: (2) small dual grommets and hardware (Min .27" - Max .53" and Min .38" - Max .70")	Small Dual Grommet Kit	911386-00-01
Small Dual Grommet Kit (10 pc grommet only) – (Min .27" - Max .53" and Min .38" - Max .70")	Small Dual Grommet Kit (10)	911495-00-00
Small 6-Port Drop Cable Kit – 2 grommets with tie wrap and foam. Allows six cable entries (Min 0.20" - Max 0.365" and flat drop)	Small 6 Port Drop Kit	FC000644
Adjustable Aerial Hanger Kit Bracket Kit (included with closure)	Adjustable Hanger LG-400/500/600	911497-00-00
Extended Offset Aerial Hanger Kit LG-400/500/600	Offset Hanger LG-400/500/600	91990-00
Retention hardware for additional cables or replacement hardware – LG-400/500/600 (no grommets)	Cable Retention Kit LG-400/500/600	FC000356
Closure Extension Kit – Used to join multiple closures for extended sheath openings required to repair cable sheath and damaged fibers	Closure Extension Kit LG-400/500/600	911499-00-00
1x6 Fiber Router Kit with furcation tubes.	1x6 Fiber Router	FC000070
Cable Grounding Kit (pack of 5) – Clamp-On Ground Cable Only	CGK-5	FC001091
*Mechanical Splice Kit. Includes 10 pieces of VHB tape. Used in all splice trays. Each piece holds 12 splices.	VHB Tape	FA000089

* See Accessory Specifications. See Splice Tray Specifications.

Qualifications

GOVERNING BODY	STANDARD CODE
Telcordia	GR-771
Rural Utilities Service (RUS)	Listed

Contact AFL for further details.

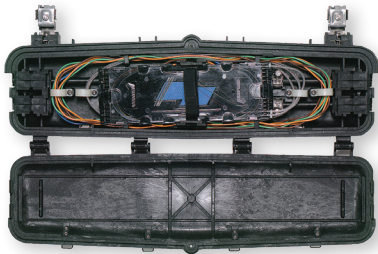

LightGuard® 500 Aerial Weathertight Fiber Optic Splice Closure

The LightGuard (LG) 500 Aerial Weathertight Fiber Optic Splice Closure is designed for medium count fiber splicing (up to 144 single or 432 mass) in a butt or in-line configuration. Utilized in aerial applications, the LG-500 is ideal for congested aerial construction due to its compact design and requires only a common can wrench for installation.

Features

- Four individual, self-sizing grommeted cable ports (expandable up to eight cable entrances)
- Patented tongue-in-groove cover seal system
- Installation and re-entry only require a common can wrench
- Cable retention clamps provide pullout
- UV resistant engineered thermoplastic

Specifications

PARAMETER	VALUE
Splice Capacity (Max.) – Single, Mass, Mechanical	144, 432, 36
Number of Splice Trays (Max.) – Single, Mass, Mechanical*	4, 3, 4
Cable Entrance Configuration	Butt or in-line
Cables	4 to 8
Cable Sizes (Min. O.D. - Max. O.D.) Included Grommets Single in. (mm) Additional Grommets Dual Grommet in. (mm)	(4) Cable Ports 4 @ 0.38" - 0.82" (7.6 - 20.8) Sm: 0.27" - 0.53" (6.9 - 13.5) Lg: 0.38" - 0.70" (9.5 - 17.8)
6-port Multi-Drop Grommet in. (mm)	0.20" - 0.37" (5.1 - 9.4)
Dimensions – (L x D) in. (mm)	27.0" x 8.3" x 4.0" (686.0 x 210.0 x 102.0)
Weight – lbs. (kg)	6.4 (2.90)

continued
→

LightGuard® 500 Aerial Weathertight Fiber Optic Splice Closure

Ordering Information

DESCRIPTION	MODEL NO.	AFL NO.
LG-500 Aerial Weathertight Fiber Optic Splice Closure – Stores 144 single fusion or 432 mass fusion, includes (4) cable kits for sealing/retention and (2) ground terminals with removable bond, and hanger brackets. Not included: Splice Trays or Cable Grounding Kits	LG-500-U-0	FC000026
LL-2400 Single Splice Tray – Stores (24) single fusion splices. Maximum of 4 trays in the LG-500.	LL-2400	91710-06
LL-2448 Universal Splice Tray – Stores (24) single fusion or (4) mass fusion splices (48 F) , *Mechanical. Maximum of 3 trays in the LG-500.	LL-2448	911289-00-02
LL-4848 Mass Splice Tray – Stores (12) mass fusion splices (144 F). Maximum of 3 trays in the LG-500.	LL-4848	911437-00-02
LL-2448-48S Single Splice Tray – Stores (48) single fusion splices. Maximum of 3 trays in the LG-500.	LL-2448-48S	FA000045
Small Single Grommet Kit (10 pc grommet only) – (Min 0.38" - Max 0.82")	Small Single Grommet Kit (10)	911496-00-00
Small Dual Grommet Kit – Includes: (2) small dual grommets and hardware (Min 0.27" - Max 0.53" and Min 0.38" - Max 0.70")	Small Dual Grommet Kit	911386-00-01
Small 6-Port Drop Cable Kit – 2 grommets with tie wrap and foam. Allows six cable entries. (Min 0.20" - Max 0.365" and flat drop)	Small 6 Port Drop Kit	FC000573
Adjustable Aerial Hanger Kit Bracket Kit (included with closure)	Adjustable Hanger LG-400/500/600	911497-00-00
Extended Offset Aerial Hanger Kit for LG-400/500/600	Offset Hanger LG-400/500/600	91990-00
Retention hardware for additional cables or replacement hardware – LG-400/500/600 (no grommets)	Cable Retention Kit LG 400/500/600	FC000356
Closure Extension Kit – Used to join multiple closures for extended sheath openings required to repair cable sheath and damaged fibers	Closure Extension Kit LG-400/500/600	911499-00-00
1x6 Fiber Router Kit with furcation tubes.	1x6 Fiber Router	FC000070
Cable Grounding Kit (pack of 5) – Clamp -On Ground Cable Only	CGK-5	FC001091
*Mechanical Splice Kit. Includes 10 pieces of VHB tape. Used in all splice trays. Each piece holds 12 splices.	VHB Tape	FA000089

* See Accessory Specifications. See Splice Tray Specifications.

Qualifications

GOVERNING BODY	STANDARD CODE
Telcordia	GR-771
Rural Utilities Service (RUS)	Listed

Contact AFL for further details.

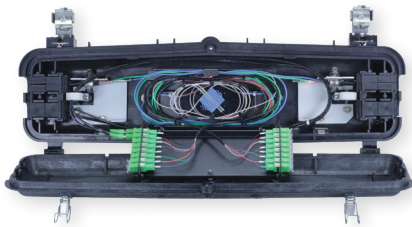

LightGuard® 500 FTTx Aerial Weathertight Fiber Optic Splice Closures

The LightGuard (LG) 500 FTTx Aerial Weathertight Fiber Optic Splice Closure is designed for small count fiber splicing (up to 32 single or 48 mass) in a butt or in-line configuration. Utilized in aerial applications, the LG-500-FTTx is ideal for FTTx access networks by providing cable entry and connectivity for up to 12 drop cables and 16 connections, requiring only a common can wrench for installation.

Features

- Four individual, self-sizing grommets cable ports:
 - 2 express ports
 - 2 multi-drop ports
- 12 drop cables and 16 connections
- Special multi-drop grommet and cable retention
- Special lock-out interior enclosure
- Patented tongue-in-groove cover seal system
- Installation and re-entry only require a common can wrench
- Cable retention clamps provide pullout
- UV resistant engineered thermoplastic

Specifications

PARAMETER	VALUE
Splice Capacity (Max.) – Single, Mass, Mechanical	32, 48, 12
Number of Splice Trays (Max.) – Single, Mass, Mechanical*	1, 1, 1
Cable Entrance Configuration	Butt or in-line
Cables	2 to 4 Express with up to 12 Drop
Cable Sizes (Min. O.D. - Max. O.D.) Included Grommets	(4) Cable Ports
Single in. (mm)	4 @ 0.38" - 0.82" (7.6 - 20.8)
6-port Multi-Drop Grommet in. (mm)	2 (6 port) @ 0.20" - 0.37" (5.1 - 9.4)
Additional Grommets	
Dual Grommet in. (mm)	Sm: 0.27" - 0.53" (6.9 - 13.5) Lg: 0.38" - 0.70" (9.5 - 17.8)
6-port Multi-Drop Grommet in. (mm)	0.20" - 0.37" (5.1 - 9.4)
Dimensions – (L x D) in. (mm)	27.0" x 8.3" x 4.0" (686.0 x 210.0 x 100.0)
Weight – lbs. (kg)	10.1 (4.58)

continued
→

LightGuard® 500 FTTx Aerial Weathertight Fiber Optic Splice Closure

Ordering Information

DESCRIPTION	MODEL NO.	AFL NO.
LG-500-FTTx Aerial Weathertight Fiber Optic Splice Closure – Stores 32 single fusion or 48 mass fusion, includes (4) cable kits for sealing/retention and (2) ground terminals with removable bond, (1) splice tray, and hanger brackets. Not included: Cable Grounding Kits, SCAPC Adapters	LG-500-FTTx	FC000899
LL-2425 Single Splice Tray – Stores (32) single fusion splices. Maximum of 1 tray in the LG-500-FTTx.	LL-2425	FC000053
Small Single Grommet Kit of (10 pc grommet only) – (Min 0.38" - Max 0.82")	Small Single Grommet Kit (10)	911496-00-00
Small Dual Grommet Kit – Includes: (2) small dual grommets and hardware (Min 0.27" - Max 0.53" and Min 0.38" - Max 0.70")	Small Dual Grommet Kit	911386-00-01
Small Dual Grommet Kit (10 pc grommet only) – (Min 0.27" - Max 0.53" and Min 0.38" - Max 0.70")	Small Dual Grommet Kit (10)	911495-00-00
Small 6-Port Drop Cable Kit – 2 grommets with tie wrap and foam tape. Allows six cable entries. (Min 0.20" - Max 0.37" and flat drop)	Small 6 Port Drop Kit	FC000573
Adjustable Aerial Hanger Kit Bracket Kit (included with closure)	Adjustable Hanger LG-400/500/600	911497-00-00
Extended Offset Aerial Hanger Kit LG-400/500/600	Offset Hanger LG-400/500/600	91990-00
Retention hardware for additional cables or replacement hardware – LG-400/500/600 (no grommets)	Cable Retention Kit LG-400/500/600	FC000356
Closure Extension Kit – Used to join multiple closures for extended sheath openings required to repair cable sheath and damaged fibers	Closure Extension Kit LG-400/500/600	911499-00-00
1x6 Fiber Router Kit with furcation tubes	1x6 Fiber Router	FC000070
Cable Grounding Kit (pack of 5) – Clamp -On Ground Cable Only	CGK-5	FC001091
Mechanical Splice Kit*. Includes 10 pieces of VHB tape. Used in all splice trays. Each piece holds 12 splices.	VHB Tape	FA000089
Single-mode SC Simplex Adapter, Flangeless, Green	SC/APC Adapter	CS009394
SC/APC 900 μm Pigtail, 1.5 Meter Length	ASC, XXX, JH, 001, Q, 001.5, White	CS012973C-001.5

* See Accessory Specifications. See Splice Tray Specifications.

Qualifications

GOVERNING BODY	STANDARD CODE
Telcordia	GR-771
Rural Utilities Service (RUS)	Listed

Contact AFL for further details.

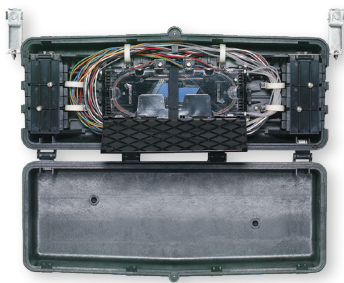

LightGuard® 600 Aerial Weathertight Fiber Optic Splice Closure

The LightGuard (LG) 600 Aerial Weathertight Fiber Optic Splice Closure is designed for high count fiber splicing (up to 384 single or 1152 mass) in a butt or in-line configuration. Utilized in aerial applications, the LG-600 is an ideal cost-effective solution for high fiber count splicing and requires only a common can wrench for installation.

Features

- Six individual, self-sizing grommets cable ports (expandable to 12 cable entrances)
- Patented tongue-in-groove cover seal system
- Installation and re-entry only require a common can wrench
- Integrated grounding clamp through aerial hangers
- Cable retention clamps provide pullout
- UV resistant engineered thermoplastic

Specifications

PARAMETER	VALUE
Splice Capacity (Max.) – Single, Mass, Mechanical	384, 1152, 36
Number of Splice Trays (Max.) – Single, Mass, Mechanical*	12, 8, 8
Cable Entrance Configuration	Butt or in-line
Cables	6 to 24
Cable Sizes (Min. O.D. - Max. O.D.) Included Grommets Single in. (mm)	(6) Cable Ports 0.44" - 1.00" (11.2 - 25.4)
Additional Grommets Dual Grommet in. (mm)	Sm: 0.40" - 0.70" (10.0 - 17.8) Lg: 0.60" - 0.90" (15.3 - 22.9)
6-port Multi-Drop Grommet in. (mm)	0.30" - 0.48" (7.6 - 17.8)
Dimensions – (L x D) in. (mm)	27.0" x 11.3" x 7.5" (690.0 x 286.0 x 190.5)
Weight – lbs. (kg)	18.0 (8.16)

continued
→

LightGuard® 600 Aerial Weathertight Fiber Optic Splice Closure

Ordering Information

DESCRIPTION	MODEL NO.	AFL NO.
LG-600 Aerial Weathertight Fiber Optic Splice Closure – Stores 384 single fusion or 1152 mass fusion, includes (4) cable kits for sealing/retention and (2) ground terminals with removable bond and hanger brackets. Not included: Splice Trays or Cable Grounding Kits	LG-600-U-0	FC000029
LL-2400 Single Splice Tray – Stores (24) single fusion splices. Maximum of 12 trays in the LG-600.	LL-2400	91710-06
LL-2448 Universal Splice Tray – Stores (24) single fusion or (4) mass fusion splices (48 F). Maximum of 8 trays in the LG-600, *Mechanical	LL-2448	911289-00-02
LL-4848 Mass Splice Tray – Stores (12) mass fusion splices (144 F). Maximum of 8 trays in the LG-600.	LL-4848	911437-00-02
LL-2448-48S Single Splice Tray – Stores (48) single fusion splices. Maximum of 8 trays in the LG-600.	LL-2448-48S	FA000045
Large Single Grommet Kit with retention hardware (Min 0.44" - Max 1.00")	Large Single Grommet Kit	FC000623
Large Single Grommet Kit (10 pc grommet only) – (Min 0.44" - Max 1.00")	Large Single Grommet Kit (10)	91918-00
Large Dual Grommet Expansion Kit – Includes: (2) Dual grommets and hardware (Min 0.40" - Max 0.70" and Min 0.60" - Max 0.90")	Large Dual Grommet Kit	911406-00-00
Large 6 Port Drop Cable Kit – 2 Grommets with retention bracket. Allows six cable entries. (Min 0.23" - Max 0.48" and flat drop)	Large 6 Port Drop Kit	FC000352
Adjustable Aerial Hanger Kit Bracket Kit (included with closure)	Adjustable Hanger LG-400/500/600	911497-00-00
Extended Offset Aerial Hanger Kit LG-400/500/600	Offset Hanger LG-400/500/600	91990-00
SC 6-pack bracket kit for LG-600	Bracket Kit (6-pack SC) LG-600	FM001294
Retention hardware for additional cables or replacement hardware – LG-400/500/600 (no grommets)	Cable Retention Kit LG-400/500/600	FC000356
Closure Extension Kit – Used to join multiple closures for extended sheath openings required to repair cable sheath and damaged fibers	Closure Extension Kit LG-400/500/600	911499-00-00
1x6 Fiber Router Kit with furcation tubes	1x6 Fiber Router	FC000070
Cable Grounding Kit (pack of 5) – Clamp -On Ground Cable Only	CGK-5	FC001091
*Mechanical Splice Kit. Includes 10 pieces of VHB tape. Used in all splice trays. Each piece holds 12 splices.	VHB Tape	FA000089

* See Accessory Specifications. See Splice Tray Specifications.

Qualifications

GOVERNING BODY	STANDARD CODE
Telcordia	GR-771
Rural Utilities Service (RUS)	Listed

Contact AFL for further details.

LightGuard® 600 FTTx Aerial Weathertight Fiber Optic Splice Closure

The LightGuard (LG) 600 FTTx Aerial Weathertight Fiber Optic Splice Closure is designed for small count fiber splicing (up to 48 single or 48 mass) in a butt or in-line configuration. Utilized in aerial applications, the LG-600-FTTx is ideal for express slack look fiber access splicing by providing cable entry and connectivity for up to 24 subscriber drops and requires only a common can wrench for installation.

Features

- Six individual, self-sizing grommets cable ports:
 - 2 express ports
 - 4 multi-drop ports
- Up to 12 adapters using the LG-600 expansion kit and SC 6-pack adapter brackets
- Special multi-drop grommets and cable retention
- Integrated aerial splicing work tray
- Patented tongue-in-groove cover seal system
- Installation and re-entry only require a common can wrench
- Integrated grounding clamp through aerial hangers
- Cable retention clamps provide pullout
- UV resistant engineered thermoplastic

Specifications

PARAMETER	VALUE
Splice Capacity (Max.) – Single, Mass, Mechanical	24, 48, 24
Number of Splice Trays (Max.) – Single, Mass, Mechanical*	2, 2, 2
Cable Entrance Configuration	Butt or in-line
Cables	2 to 4 Express with up to 24 Drops
Cable Sizes (Min. O.D. - Max. O.D.) Included Grommets	(6) Cable Ports 2 @ 0.44" - 1.00" (11.2 - 25.4) 4 @ 0.30" - 0.48" (76 - 17.8)
Single in. (mm)	
6-port Multi-Drop Grommet in. (mm)	
Additional Grommets	
Dual Grommet in. (mm)	Sm: 0.40" - 0.70" (10.0 - 17.8) Lg: 0.60" - 0.90" (15.3 - 22.9)
Dimensions – (L x D) in. (mm)	27.00" x 11.25" x 7.50" (690.0 x 286.0 x 190.5)
Weight – lbs. (kg)	18.0 (8.16)

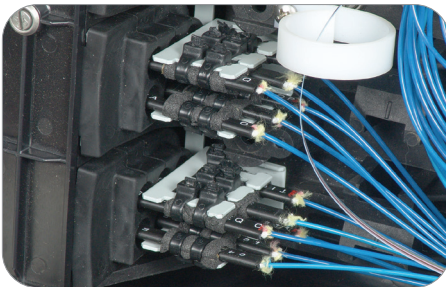
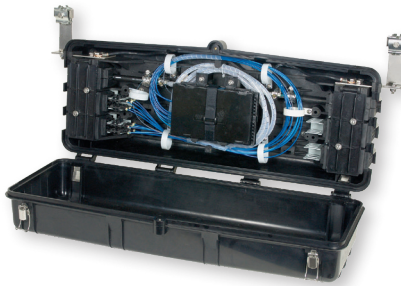

Cable entrance



Grommet bracket

continued
→

LightGuard® 600 FTTx Aerial Weathertight Fiber Optic Splice Closure

Ordering Information

DESCRIPTION	MODEL NO.	AFL NO.
LG-600-FTTx Aerial Weathertight Fiber Optic Splice Closure – Stores 24 single fusion or 48 mass fusion, includes (6) cable kits for sealing/retention and (2) ground terminals with removable bond, (2) splice tray, and hanger brackets. Not included: Cable Grounding Kits	LG600-FTTx	FC000291
LL-2450 Single Splice Tray – Stores (12) single fusion splices. Maximum of (2) trays in the LG-600-FTTx.	LL-2450	91957-00
LL-4850 Mass Splice Tray – Stores (8) mass fusion splices (96F). Maximum of (2) trays in the LG-600-FTTx.	LL-4850	91958-00
LL-1248 Universal Splice Tray – Stores (12) single fusion splices or (8) mass fusion splices (96F), *Mechanical. Maximum of 2 trays in the LG-600FTTx.	LL-1248	911221-00-00
Large Single Grommet Kit with retention hardware (Min 0.44" - Max 1.00")	Large Single Grommet Kit	FC000623
Large Single Grommet Kit (10 pc grommet only) – (Min 0.44" - Max 1.00")	Large Single Grommet Kit (10)	91918-00
Adjustable Aerial Hanger Kit Bracket Kit (included with closure)	Adjustable Hanger LG-400/500/600	911497-00-00
Extended Offset Aerial Hanger Kit – LG-400/500/600	Offset Hanger LG-400/500/600	91990-00
Retention hardware for additional cables or replacement hardware – LG/400/500/600 (no grommets)	Cable Retention Kit LG-400/500/600	FC000356
Closure Extension Kit – Used to join multiple closures for extended sheath openings required to repair cable sheath and damaged fibers	Closure Extension Kit LG-400/500/600	911499-00-00
1x6 Fiber Router Kit with furcation tubes	1x6 Fiber Router	FC000070
Cable Grounding Kit (pack of 5) – Clamp-On Ground Cable Only	CGK-5	FC001091
*Mechanical Splice Kit. Includes 10 pieces of VHB tape. Used in all splice trays. Each piece holds 12 splices.	VHB Tape	FA000089
LG-600 FTTx Expansion Kit – Includes (1) Stacker Module, (1) SC-6-Pack Bracket. Allows use of standard splice trays.	LG-600 FTTx Expansion Kit	FC000620

* See Accessory Specifications. See Splice Tray Specifications.

Qualifications

GOVERNING BODY	STANDARD CODE
Telcordia	GR-771
Rural Utilities Service (RUS)	Listed

Contact AFL for further details.

LightLink Fiber Optic Splice Trays

AFL's LightLink series of Fiber Optic Splice Trays offers a variety of unique and flexible splice and storage possibilities. They are available in industry standard configurations (single, mass).

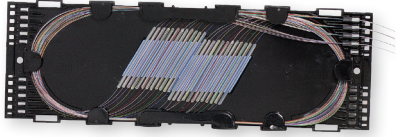

Features

- In-line or butt splice capability (see model descriptions)
- Pre-formed radiuses maintain bend requirements
- Interlocking base and cover provides tray stability without the use of a bolt
- Extended finger guides easily store and route loose fiber or ribbon

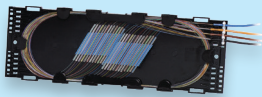

Ordering Information—Splice Trays for Sealed Fiber Optic Splice Closures

DESCRIPTION	MODEL NO.	AFL NO.	LG-55-U	LG-150-U	LG-250-U	LG-350-U	LG-350-20-WTC	LG-350-27-WTC
Single Fuse: 32 Mass Fuse: N/A 6.300" (L) x 2.730" (W) x 0.829" (H) 	LL-2425	FC000053	Max trays: 1 Single: 32 Mass: N/A	N/A	N/A	N/A	N/A	N/A
Single Fuse: 12 Mass Fuse: N/A 7.139" (L) x 4.294" (W) x 0.370" (H) 	LL-2450	91957-00	N/A	Max Trays: 4 Single: 48 Mass: N/A	N/A	N/A	N/A	N/A
Single Fuse: N/A Mass Fuse: 8 (96 fiber) 7.139" (L) x 4.294" (W) x 0.370" (H) 	LL-4850	91958-00	N/A	Max Trays: 4 Single: N/A Mass: 32 (384 fiber)	N/A	N/A	N/A	N/A
Single Fuse: 12 Mass Fuse: 8 (96 fiber) 7.139" (L) x 4.294" (W) x 0.370" (H) 	LL-1248	911221-00-00	N/A	Max Trays: 4 Single: 48 Mass: 48 (384 fiber)	N/A	N/A	N/A	N/A
Single Fuse: 24 Mass Fuse: N/A 12.542" (L) x 4.042" (W) x 0.390" (H) 	LL-2400	91710-06	N/A	N/A	Max Trays: 5 Single: 120 Mass: N/A	Max Trays: 13 Single: 312 Mass: N/A	N/A	N/A

continued
→

LightLink Fiber Optic Splice Trays (cont.)

Ordering Information—Splice Trays for Sealed Fiber Optic Splice Closures

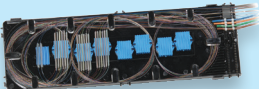
DESCRIPTION	MODEL NO.	AFL NO.	LG-250-U	LG-350-U	LG-350-AC	LG-350XL-U	LG-350-20-WTC	LG-350-27-WTC
Single Fuse: 60 Mass Fuse: 12 (144 fiber) 12.000" (L) x 5.125" (W) x 0.485" (H)  *Note: Contains enough splice holders for 24 mass splices (288 fibers) when using AFL Wrapping Tube Cable.	LL-7644	FA000044	N/A	Max Trays: 6 Single: 360 Mass: 72 (864 fiber)	N/A	N/A	N/A	Max Trays: 3 Single: 180 Mass: 72 (864 fiber)
Single Fuse: 24 Mass Fuse: 4 (48 fiber) 12.542" (L) x 4.270" (W) x 0.531" (H) 	LL-2448	911289-00-02	Max Trays: 3 Single: 72 Mass: 12 (144 fiber) Mechanical: 36	Max Trays: 8 Single: 192 Mass: 32 (384 fiber) Mechanical: 96	N/A	N/A	N/A	N/A
Single Fuse: 48 Mass Fuse: N/A 12.542" (L) x 4.270" (W) x 0.531" (H) 	LL-2448-48S	FA000045	Max Trays: 3 Single: 144 Mass: N/A	Max Trays: 8 Single: 384 Mass: N/A	N/A	N/A	N/A	N/A
Single Fuse: N/A Mass Fuse: 12 (144 fiber) 12.542" (L) x 4.270" (W) x 0.531" (H) 	LL-4848	911437-00-02	Max Trays: 3 Single: N/A Mass: 36 (432 fiber)	Max Trays: 8 Single: N/A Mass: 96 (1152 fiber)	N/A	N/A	N/A	N/A
Single Fuse: 96 Mass Fuse: 24 (288 fiber) 15.950" (L) x 4.875" (W) x 0.485" (H) 	LL-4896	911676-00-02	N/A	Max Trays: 5 Single: 480 Mass: 120 (1440 fiber)	N/A	Max Trays: 9 Single: 864 Mass: 216 (2592 fiber)	N/A	N/A
Single Fuse: 60 Mass Fuse: N/A 12.000" (L) x 5.125" (W) x 0.485" (H) 	LL-7060	FA000042	N/A	Max Trays: 6 Single: 360 Mass: N/A	N/A	N/A	N/A	Max Trays: 3 Single: 180 Mass: N/A

continued 

LightLink Fiber Optic Splice Trays (cont.)

Ordering Information – Splice Trays for LG-350 and LG-350XL-U Sealed Fiber Optic Splice Closures

DESCRIPTION	MODEL NO.	AFL NO.	LG-350-U	LG-350-AC	LG-350XL-U	LG-350-20-WTC	LG-350-27-WTC
Single Fuse: N/A Mass Fuse: 12 (144 fiber) 12.000" (L) x 5.125" (W) x 0.485" (H) 	LL-7144	FA000043	Max Trays: 6 Single: 360 Mass: 72 (864 fiber)	N/A	N/A	N/A	Max Trays: 3 Single: 180 Mass: 72 (864 fiber)
Single Fuse: 36 Mass Fuse: 12 (144 fiber) 8.125" (L) x 4.875" (W) x 0.485" (H) 	LL-4808L-R	FA000037	N/A	Max Trays: 4 Single: 144 Mass: 48 (576 fiber)	N/A	Max Trays: 4 Single: 144 Mass: 48 (576 fiber)	N/A
Single Fuse: N/A Mass Fuse: 12 (144 fiber) 8.125" (L) x 4.875" (W) x 0.485" (H) 	LL-4808 R	FA000020	N/A	Max Trays: 4 Single: N/A Mass: 48 (576 fiber)	N/A	Max Trays: 4 Single: N/A Mass: 48 (576 fiber)	N/A
Single Fuse: 36 Mass Fuse: N/A 8.125" (L) x 4.875" (W) x 0.485" (H) 	LL-4808 L	FA000021	N/A	Max Trays: 4 Single: 144 Mass: N/A	N/A	Max Trays: 4 Single: 144 Mass: N/A	N/A
Single Fuse: N/A Mass Fuse: 24 (288 fiber) 15.950" (L) x 4.875" (W) x 0.485" (H) 	LL-4896 R	FA000022	Max Trays: 5 Single: N/A Mass: 120 (1440 fiber)	N/A	Max Trays: 9 Single: N/A Mass: 216 (2592 fiber)	N/A	N/A
Single Fuse: 96 Mass Fuse: N/A 15.950" (L) x 4.875" (W) x 0.485" (H) 	LL-4896 L	FA000023	Max Trays: 5 Single: 480 Mass: N/A	N/A	Max Trays: 9 Single: 864 Mass: N/A	N/A	Max Trays: 3 Single: 180 Mass: N/A

continued
→

Splice Trays

LightLink Fiber Optic Splice Trays (cont.)

Ordering Information – Splice Trays for Aerial Weathertight Fiber Optic Splice Closures

DESCRIPTION	MODEL NO.	AFL NO.	LG-410-U	LG-420-U FTTx	LG-500-U	LG-500-U FTTx
Single Fuse: 24 Mass Fuse: N/A 12.542" (L) x 4.042" (W) x 0.390" (H) 	LL-2400	91710-06	Max Trays: 4 Single: 96 Mass: N/A	N/A	Max Trays: 4 Single: 96 Mass: N/A	N/A
Single Fuse: 32 Mass Fuse: N/A 6.300" (L) x 2.730" (W) x 0.829" (H) 	LL-2425	FC000053	N/A	Max Trays: 1 Single: 32 Mass: N/A	N/A	Max Trays: 1 Single: 32 Mass: N/A
Single Fuse: 24 Mass Fuse: 4 (48 fiber) 12.542" (L) x 4.270" (W) x 0.531" (H) 	LL-2448	911289-00-02	Max Trays: 3 Single: 72 Mass: 12 (144 fiber) Mechanical: 36	N/A	Max Trays: 3 Single: 72 Mass: 12 (144 fiber) Mechanical: 36	N/A
Single Fuse: 12 Mass Fuse: N/A 7.139" (L) x 4.294" (W) x 0.370" (H) 	LL-2450	91957-00	N/A	N/A	N/A	N/A
Single Fuse: N/A Mass Fuse: 12 (144 fiber) 12.542" (L) x 4.270" (W) x 0.531" (H) 	LL-4848	911437-00-02	Max Trays: 3 Single: N/A Mass: 36 (432 fiber)	N/A	Max Trays: 3 Single: N/A Mass: 36 (432 fiber)	N/A
Single Fuse: N/A Mass Fuse: 8 (96 fiber) 7.139" (L) x 4.294" (W) x 0.370" (H) 	LL-4850	91958-00	N/A	N/A	N/A	N/A
Single Fuse: 12 Mass Fuse: 8 (96 fiber) 7.139" (L) x 4.294" (W) x 0.370" (H) 	LL-1248	911221-00-00	N/A	N/A	N/A	N/A

continued
→

LightLink Fiber Optic Splice Trays (cont.)

Ordering Information – Splice Trays for Aerial Weathertight Fiber Optic Splice Closures

DESCRIPTION	MODEL NO.	AFL NO.	LG-500-U-FTTx-ISO	LG-600-U	LG-600-FTTx	LG-600-U-FTTx-ISO
Single Fuse: 24 Mass Fuse: N/A 12.542" (L) x 4.042" (W) x 0.390" (H) 	LL-2400	91710-06	N/A	Max Trays: 12 Single: 288 Mass: N/A	Max Trays: 2 Single: 48 Mass: N/A	N/A
Single Fuse: 32 Mass Fuse: N/A 6.300" (L) x 2.730" (W) x 0.829" (H) 	LL-2425	FC000053	N/A	N/A	N/A	N/A
Single Fuse: 24 Mass Fuse: 4 (48 fiber) 12.542" (L) x 4.270" (W) x 0.531" (H) 	LL-2448	911289-00-02	N/A	Max Trays: 8 Single: 192 Mass: 32 (384 fiber) Mechanical: 12	N/A	N/A
Single Fuse: 12 Mass Fuse: N/A 7.139" (L) x 4.294" (W) x 0.370" (H) 	LL-2450	91957-00	Max Trays: 1 Single: 12 Mass: N/A	N/A	N/A	Max Trays: 2 Single: 24 Mass: N/A
Single Fuse: N/A Mass Fuse: 12 (144 fiber) 12.542" (L) x 4.270" (W) x 0.531" (H) 	LL-4848	911437-00-02	N/A	Max Trays: 8 Single: N/A Mass: 96 (1152 fiber)	N/A	N/A
Single Fuse: N/A Mass Fuse: 8 (96 fiber) 7.139" (L) x 4.294" (W) x 0.370" (H) 	LL-4850	91958-00	Max Trays: 1 Single: N/A Mass: 8 (96 fiber)	N/A	N/A	Max Trays: 2 Single: N/A Mass: 16 (192 fiber)
Single Fuse: 12 Mass Fuse: 8 (96) 7.139" (L) x 4.294" (W) x 0.370" (H) 	LL-1248	911221-00-00	Max Trays: 1 Single: 12 Mass: 8 (96 fiber)	N/A	N/A	Max Trays: 2 Single: 24 Mass: 16 (192 fiber)

continued





Splice Trays

LightLink Fiber Optic Splice Trays (cont.)

Ordering information – Splice Trays for Aerial Weathertight Fiber Optic Splice Closures

DESCRIPTION	MODEL NO.	AFL NO.	LG-410-U	LG-500-U	LG-600-U
Single Fuse: N/A Mass Fuse: 4 (48 fiber) 12.542" (L) x 4.270" (W) x 0.531" (H) 	LL-4800	91711-07	Max Trays: 3 Single: N/A Mass: 12 (144 fiber)	Max Trays: 3 Single: N/A Mass: 12 (144 fiber)	Max Trays: 8 Single: N/A Mass: 32 (384 fiber)

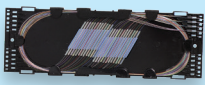
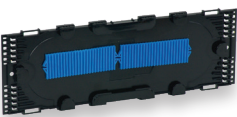
Ordering Information—Splice Trays for Fiber Optic Enclosures

DESCRIPTION	MODEL NO.	AFL NO.	LL-400B WITH INTERCONNECT	LL-400B WITHOUT INTERCONNECT	LL-400SX WITH 2 LGX® PLATES	LL-400SX WITHOUT LGX PLATES
Single Fuse: 24 Mass Fuse: 4 (48 fiber) Mechanical : 12 12.542" (L) x 4.270" (W) x 0.531" (H) 	LL-2448	911289-00-02	Max Trays: 4 Single: 96 Mass: 16 (192 fiber) Mechanical: 48	Max Trays: 6 Single: 144 Mass: 24 (288 fiber) Mechanical: 72	Max Trays: 3 Single: 72 Mass: 12 (144 fiber) Mechanical: 36	Max Trays: 9 Single: 216 Mass: 36 (432 fiber) Mechanical: 108
Single Fuse: 48 Mass Fuse: N/A 12.542" (L) x 4.270" (W) x 0.531" (H) 	LL-2448-48S	FA000045	Max Trays: 4 Single: 192 Mass: N/A	Max Trays: 6 Single: 288 Mass: N/A	Max Trays: 3 Single: 144 Mass: N/A	Max Trays: 9 Single: 432 Mass: N/A
Single Fuse: N/A Mass Fuse: 12 (144 fiber) 12.542" (L) x 4.270" (W) x 0.531" (H) 	LL-4848	911437-00-02	Max Trays: 4 Single: N/A Mass: 48 (576 fiber)	Max Trays: 6 Single: N/A Mass: 72 (864 fiber)	Max Trays: 3 Single: N/A Mass: 36 (432 fiber)	Max Trays: 9 Single: N/A Mass: 108 (1296 fiber)
Single Fuse: N/A Mass Fuse: 4 (48 fiber) 12.542" (L) x 4.270" (W) x 0.531" (H) 	LL-4800	91711-07	Max Trays: 4 Single: N/A Mass: 16 (192 fiber)	Max Trays: 6 Single: N/A Mass: 24 (288 fiber)	Max Trays: 3 Single: N/A Mass: 12 (144 fiber)	Max Trays: 9 Single: N/A Mass: 108 (1296 fiber)

continued
→

LightLink Fiber Optic Splice Trays (cont.)

Ordering Information—Splice Trays for Fiber Optic Enclosures

DESCRIPTION	MODEL NO.	AFL NO.	LL-500	LL-580
Single Fuse: N/A Mass Fuse: 12 (144 fiber) 12.000" (L) x 5.125" (W) 0.485" (H) 	LL-7144	FA000043	N/A	Max Trays: 2 Single: N/A Mass: 24 (288 fiber)
Single Fuse: 60 Mass Fuse: 12 (144) 12.000" (L) x 5.125" (W) 0.485" (H) 	LL-7644	FA000044	N/A	Max Trays: 2 Single: 120 Mass: 24 (288 fiber)
Single Fuse: 12 Mass Fuse: N/A 7.139" (L) x 4.294" (W) x 0.370" (H) 	LL-2450	91957-00	Max Trays: 5 Single: 60 Mass: N/A	N/A
Single Fuse: N/A Mass Fuse: 8 (96 fiber) 7.139" (L) x 4.294" (W) x 0.370" (H) 	LL-4850	91958-00	Max Trays: 3 Single: N/A Mass: 24 (288 fiber)	N/A
Single Fuse: 36 Mass Fuse: 12 (144 fiber) 8.125" (L) x 4.875" (W) x 0.485" (H) 	LL-4808L-R	FA000037	N/A	Max Trays: 2 Single: 72 Mass: 24 (288 fiber)

continued
→

LightLink Fiber Optic Splice Trays (cont.)

Ordering Information – Splice Tray for Splicing Cabinets and Shelves

DESCRIPTION	MODEL NO.	AFL NO.
Telescoping Splice Tray - Stores up to 48 single fusion sleeves or 12 mass fusion sleeves (144 fibers). For use in the following products: LL-300, LL-288/576, LL-720/1440, OTSS-SYS1, OSS-SYS2 and OSS-SYS1	STF-48	911442-00-00
FTTx Splice Tray - Stores up to 2 single fusion sleeves. For use in the following products: ONT-760XL, ONT-3000 and CG-1500	—	DM000445
Bare Fiber Splice Tray - Stores up to 24 single fusion fibers without sleeves. For use in the following products: Any product that accepts the LL-2400 splice tray	—	C184190

Ordering Information—Splice Tray Accessories

DESCRIPTION	AFL NO.
FP-40 Splice Protection Sleeves, 40 mm length (1000 box/100 pack)	S015916
FP-60 Splice Protection Sleeves, 60 mm length (1000 box/100 pack)	S015915
Single Fusion Splice Chip - 6 splices per chip. (10 pcs. per kit)	FA000034
Single Fusion Splice Chip - 12 splices per chip. (10 pcs. per kit)	FC000657
Single Fusion Splice Chip - 24 splices per chip. (10 pcs. per kit)	91745-02
Mass Fusion Splice Chip - 4 splices per chip. (10 pcs. per kit)	FA000088
Mechanical Fusion Splice Tape (10 pcs. per kit)	FA000089
Core Tube Cable Fiber Router for routing fiber up to 8 directions. For all central core tube sizes.	FC000008
Loose Tube or Ribbon Router for routing fiber up to 6 directions. For all Loose Tube and up to 12 fiber Ribbon.	FC000070

Dimensions

LL-2448 and LL-4848 Splice Trays

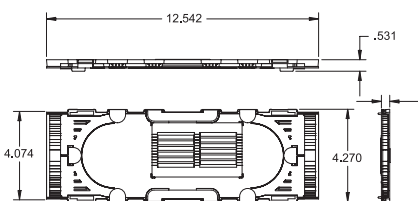

LL-1248, LL-2450 and LL-4850 Splice Trays

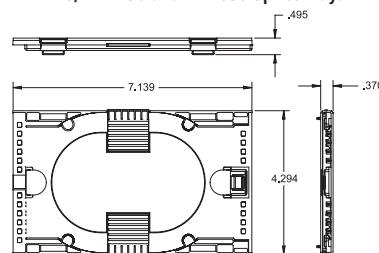

LL-2400 Splice Tray

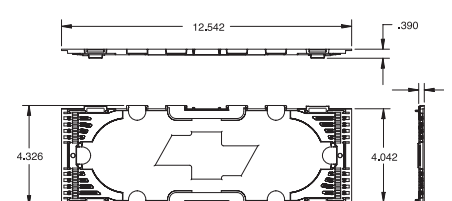

LL-4896 Splice Tray

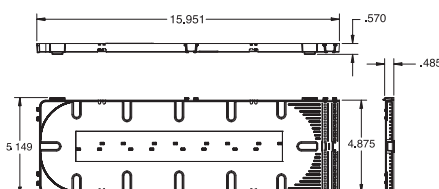

LL-2425 Splice Tray

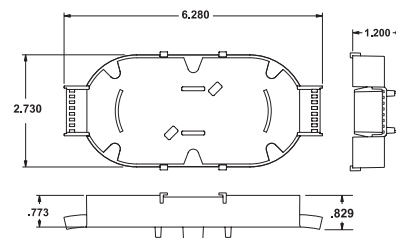

OEE Splice Tray

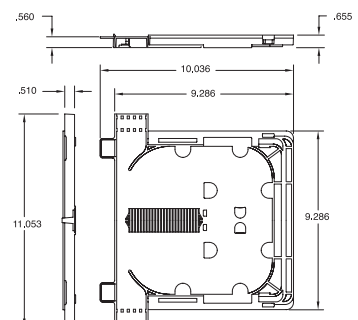



Fiber Storage Units

AFL Fiber Storage Units (FSU) are used to conveniently and safely store an extra length of cable along the support strand for later use. Furnished as pairs (kit contains two Fiber Storage Units and two sets of hanger brackets), these FSU's are constructed from either aluminum with a baked acrylic enamel finish or dielectric polypropylene with a UV inhibitor. All basic hardware for attachment to the support strand is provided. Strand mount support brackets meet Telcordia® specifications. Galvanized strand clamping devices accommodate 1/4" to 7/16" strand and meet ASTM specifications A153 and B695.

Features

- Small profile and side facing channel minimizes ice and leaf loading
- Metal versions feature an all aluminum construction with welded cross members and baked acrylic enamel paint finish with chromate pre-finish per MIL-6-5541-B
- Plastic versions feature thermoplastic polypropylene resin with carbon black UV inhibitor
- Basic hanging hardware (bolts, nuts, washers) and strand clamps all included
- Tie-wrap slots for securing cable from sliding
- Galvanized strand clamps accommodate 1/4" to 7/16" strand



Reserve Cable Storage

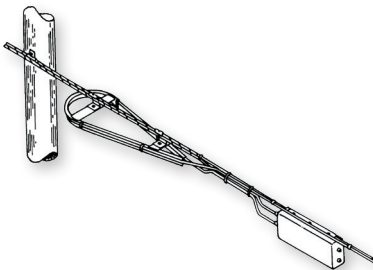

Butt Splice

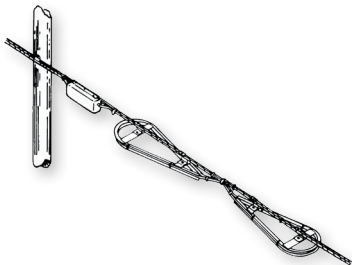

In-Line Splice

Specifications

PARAMETER	FSU-10	FSU-12	FSU-16	FSU-18	FSU-20	FSU-24
Nom. Channel Width in. (cm)	0.63 (1.60)	0.92 (2.34)	1.12 (2.84)	1.75 (4.45)	1.75 (4.45)	1.745 (4.5)
Min. Bend Diameter in. (cm)	10 (25.4)	12 (30.48)	16 (40.64)	18 (45.72)	20 (50.80)	24.125 (61.3)

PARAMETER	FOSP-12-TMK	FOSP-17-TMK
Nom. Channel Width in. (cm)	0.63 (1.59)	0.95 (2.41)
Min. Bend Diameter in. (cm)	12.13 (30.80)	17.5 (44.45)

Ordering Information

DESCRIPTION	FSU-10	FSU-12	FSU-16	FSU-18	FSU-20	FSU-24
FSU Kit	911107-00	911108-00	911109-00	911110-00	911944-00-00	FA000095

DESCRIPTION	FOSP-12-TMK	FOSP-17-TMK
FOSP Kit (Dielectric)	FA000004	FA000002

Kits contain one pair of either FSU or FOSP and four mount brackets.

Qualifications

GOVERNING BODY	STANDARD CODE
ASTM	ASTM A153, ASTM B695
Telcordia	MIL-6-5541-B

Hardware Diagram

