



## FUSION SPLICING SYSTEMS

Fusion Splicers | Cleavers | Tools & Supplies | Software

AFL is a value-added supplier. We strive to provide more than just a product and look far beyond the current sale in an effort to build a long term, business relationship with our customers. The Fusion Splicing team provides fast, dependable support after the sale centered on service, trust, and friendship in support of customer needs.

**Some of the positive, proactive things we do include:**

- Free 24/7 technical support for all AFL customers - 800-866-3602
- Free software upgrades that enhance equipment performance and customer satisfaction
- Free product demonstrations for guiding customers and understanding their needs
- Free training videos to enhance the customer learning experience
- Engineering support to assist with special splicing applications
- High quality repair service using only Fujikura approved parts and repair techniques
- Best in the industry repair turnaround time to minimize customer down time
- Optional expedited repair service for special time critical customer events
- Loaner equipment for special case circumstances, when available
- Large supply of inventory, enabling short lead-times for critical need products
- A staff dedicated to serving the customer's needs quickly and efficiently

Thank you for choosing AFL and Fujikura fusion splicing products!

Please visit us online at [www.AFLglobal.com](http://www.AFLglobal.com).



## Table of Contents

### Field Fusion Splicing Equipment

#### Splicers – Single Fiber

Fujikura 90S+ Fusion Splicer	3
Fujikura 45S Fusion Splicer <b>NEW</b>	6
Fujikura 35S Fusion Splicer <b>NEW</b>	10

#### Splicers – Ribbon Fiber

Fujikura 90R Fusion Splicer	14
-----------------------------	----

#### Cleavers

CT50 Fiber Cleaver	17
CT16 Fiber Cleaver <b>NEW</b>	19

#### Strippers

Thermal Strippers	21
-------------------	----

#### Splice Protection

Splice Protection Sleeves	23
---------------------------	----

#### Ribbon Fiber Tools

RT-02 Ribbonizing Tool	25
FST-12 Fiber Separation Tool	26
Fiber Arrangement Tool	27
Ribbon Forming Adhesive	27

#### Cleaning

Splicer V-groove Cleaning Kit	28
-------------------------------	----

#### Misc. Accessories

Portable Tripod Workstation	29
ASW-02 Splicing Workstation	30
TJ-03 Temporary Joining Tool	31

### Specialty Fusion Splicing Equipment

#### Splicers

<b>LAZERM</b> Master® LZM-125A+ Splicing System	32
<b>LAZERM</b> Master LZM-125M/LZM-125P Splicing System	34
<b>LAZERM</b> Master LZM-125M+/LZM-125P+ Splicing System	36
<b>LAZERM</b> Master LZM-100 <b>LAZERM</b> Master® Laser Splicing System	38
<b>ARCM</b> Master® FSM-100M and FSM-100P Fusion Splicers	40

#### Recoaters and Splice Protection

FSR-115, FSR-116 and FSR-117 Optical Fiber Recoaters	42
Splice Protection Sleeves	47

#### Fiber Cleavers

CT52 Fiber Cleaver	49
CT58 Fiber Cleaver	51
CT-114, CT-115 and CT-116 Fiber Cleavers	53
CT-110 and CT-111 Tension-Method Fiber Cleavers <b>NEW</b>	58

#### Stripping, Cleaning and Fiber Prep Automation

PowerCleave®	61
SS-110 Specialty Fiber Stripper	62
AFL PowerStrip®	64
High Tensile Stripper	65
PCS-100 Polyimide Coating Stripper	66
APM-101 and APM-102 Automatic Preparation Machine	67
USC-03 Ultrasonic Cleaner	68







Bluetooth®

90S+

## Fujikura 90S+ Fusion Splicer

The Fujikura 90S+ core alignment fusion splicer solves common problems seen in the field—from splicing poor quality legacy fiber to automated equipment maintenance and upkeep. The Fujikura 90S+ can be use in multiple field splicing applications including bend-insensitive fibers in drop cables, long-haul terrestrial and submarine LEAF® fibers, loose buffer fiber, splice-on connectors, and the list goes on. The speed and accuracy of the 90S+ make it suitable for certain production and specialty environments where high output, tight packaging, and low loss requirements are required.

Regardless of your scenario, the Fujikura 90S+ is designed to keep you in the field with an extended battery life of 300 splice and heat cycles. With its multiple automated and easy-to-use features, the 90S+ alleviates the need for traditional operation tasks such as frequent arc calibrations, cleaver blade rotations, cleaver usage tracking, and manual splicing operations. A redesigned work tray, cooling tray, and optional cable clamp make the 90S+ kit more versatile than its predecessors in adapting to varying work conditions and environments.

When splicing loose buffer fiber, additional sheath clamps are not needed. The standard universal sheath clamp now handles both loose and tight buffer fibers. The new Active Fusion Control (AFC) technology improves splice losses for fibers that possess a poor cleave angle. Combined with Active Blade Management between the splicer and cleaver, the Fujikura 90S+ contains a robust set of splicing features that will reduce the likelihood of poor splice installations or repairs.



In Work Tray



Wind Protector Open

### Features

- Cleaver tracking and upkeep with wireless communication
- Improved real-time arc control for fibers with poor cleave angles
- Automated wind protector, sheath clamps and splice operation
- Loose and tight buffer with same sheath clamp
- Lithium-ion battery with 300 splices/shrinks per charge
- PC software and 90S+ manual downloaded from splicer
- Multi-function transit case with integrated workstation

### Applications

- Distribution fiber repair
- Long-haul network installation
- Field termination with splice-on connectors
- Access network installation
- Fanout kits, pigtails and splice cassettes
- OSP cable installation and repair
- Optical modules – splitters, couplers, MUXs, EDFAs and attenuators

**STOCK ITEM**

## Fujikura 90S+ Fusion Splicer

### Ordering Information

DESCRIPTION	AFL NO.
<b>90S+ Fusion Splicer (machine only)</b> <b>Includes:</b> ADC-20 AC Adapter, ACC-14 AC Cord, BTR-15 Battery, ELCT2-16B Spare Electrodes (pair), Sheath Clamps, SP-03 Fiber Holder Set Plates, USB-01 Cable, Alcohol Dispenser, Screwdriver, Splicer Carrying Strap, Quick Reference Guide, TS-03 Tripod Screw, Work Tray J-Plate, SS03 single fiber stripper, CC39 Transit Case with Carrying Strap and Two Year Warranty	S017519
<b>90S+ Fusion Splicer Kit (with cleaver)</b> <b>Includes:</b> CT50 Cleaver, ADC-20 AC Adapter, ACC-14 AC Cord, BTR-15 Battery, ELCT2-16B Spare Electrodes (pair), Sheath Clamps, SP-03 Fiber Holder Set Plates, USB-01 Cable, Alcohol Dispenser, Screwdriver, Splicer Carrying Strap, Quick Reference Guide, TS-03 Tripod Screw, Work Tray J-Plate, SS03 single fiber stripper, CC39 Transit Case with Carrying Strap and Two Year Warranty	S017521
<b>90S+ Fusion Splicer without Bluetooth (machine only)</b> <b>Includes:</b> ADC-20 AC Adapter, BTR-15 Battery, ACC-14 AC Cord, ELCT2-16B Spare Electrodes (pair), Sheath Clamps, SP-03 Fiber Holder Set Plates, USB-01 Cable, Alcohol Dispenser, Screwdriver, Splicer Carrying Strap, Quick Reference Guide, TS-03 Tripod Screw, Work Tray J-Plate, SS03 Single Fiber Stripper, CC39 Transit Case with Carrying Strap and Two Year Warranty	S017520
One Year Extended Warranty	S012996
Two Year Extended Warranty	S013000

### Recommended Products for the 90S+

DESCRIPTION	AFL NO.
<b>Cleavers</b>	
CT-16 Cleaver	S018330
CT-50 Cleaver	S017030
<b>Fiber Holders (pair)</b>	
FH-70-250 (250 μm coated fiber)	S017111
FH-70-900 (900 μm jacketed fiber)	S017113
FH-70-160 (160 μm coated fiber)	S017095
FH-70-200 (200 μm coated fiber)	S017711
FH-60-LT900 (Loose buffer 900 μm fiber)	S015181
<b>FUSEConnect® Accessories</b>	
FH-FC-20 (900 μm within 2.0 mm sheathing) (each)	S014696
FH-FC-30 (900 μm within 3.0 mm sheathing) (pair)	S014695
FH-FC-900 (900 μm cable) (each)	S014697
CLAMP-FC-2000 (pair)	S014705
CLAMP-FC-3000 (single holder)	S014704
<b>Power Supply Options and Equipment</b>	
ADC-20 AC Adapter	S017513
ACC-14 AC Power Cord	S014536
BTR-15 Battery	S017512
DCC-20 Power Cord (connects AC Adapter to cigarette lighter socket)	S017527
DCC-21 Power Cord (connects AC Adapter to power source via alligator clips)	S017528

DESCRIPTION	AFL NO.
<b>Miscellaneous</b>	
SS03 Single fiber stripper (3 hole)	S017098
SS01 Single fiber stripper (1 hole)	S017099
ELCT2-16B Electrodes	S017103
SP-03 Fiber Holder Set Plates	S017518
S90 Universal Sheath Clamps	S017696
Portable Tripod Workstation (see product profile for more detail)	S014773
ASW-02 Splicing Workstation (see product profile for more detail)	S010532
WT-09R Work Tray Right	S017515
WT-09L Work Tray Left	S017516
JP-09 Work Tray J-Plate	S017517
JP-10 J-Plate (Cooling tray attaches to splicer)	S017522
JP-10-FC J-Plate with Fiber Clamps	S017523
TS-03 Tripod Screw (90 Series)	S017524
ST-02 Fusion Splicer Strap	S017525
CLAMP-DC-12 (Drop cable clamp for work tray)	S017550
USB-01 Cable	S014777
CC39 Transit Case	S017514
Splicer V-Groove Cleaning Kit	S014397
ST-03 Case and Work Tray Strap	S017549



#### Fiber Holders

- Wide range of sizes for various applications
- Loose & Tight Buffer options available



#### Portable Tripod Work Station

- Sturdy work tray supports the splicer, cleaver and accessories
- Tripod supports a load capacity of up to eleven pounds



#### V-Groove Cleaning Kit

- Removes environmental contamination from the v-groove of the splicer
- Maintains performance and ensures fiber alignment

## Fujikura 90S+ Fusion Splicer

### Specifications

PARAMETER		VALUE
Fiber Alignment Method		Active core alignment
Fiber Count Can Be Spliced		Single fiber
Applicable Fiber	Fiber Type	Single-mode optical fiber Multimode optical fiber
	Cladding Diameter	80 to 150 $\mu$ m
Applicable Coating	Sheath Clamp	Coating dia.: Max. 3,000 $\mu$ m Cleave length: 5 to 16 mm
	Splice Loss	ITU-T G.652: Avg. 0.02 dB ITU-T G.651: Avg. 0.01 dB ITU-T G.653: Avg. 0.04 dB ITU-T G.654: Avg. 0.04 dB ITU-T G.655: Avg. 0.04 dB ITU-T G.657: Avg. 0.02 dB
Fiber Splice Performance	Splice Time	SM FAST mode: Avg. 8 to 10 sec. SMAUTO mode: Avg. 11 to 13 sec. AUTO mode: Avg. 14 to 16 sec.
	Sleeve Type	Heat-shrinkable sleeve
Applicable Protection Sleeve	Sleeve Length	Max. 66 mm
	Sleeve Dia.	Max. 6.0 mm before shrinking
Sleeve Heat Performance	Heat Time	60 mm slim mode: Avg. 9 to 10 sec. 60 mm mode: Avg. 13 to 15 sec.
Fiber Tensile Test Force		Approx. 2.0 N
Electrode Life		Approx. 5,000 splices
Physical Description	Dimensions W	Approx. 170 mm without projection
	Dimensions D	Approx. 173 mm without projection
	Dimensions H	Approx. 150 mm without projection
	Weight	Approx. 2.8 kg including battery
Environmental Condition	Temperature	Operate: -10 to 50°C Storage: -40 to 80°C
	Humidity	Operate: 0 to 95% RH non-condensing Storage: 0 to 95% RH non-condensing
	Altitude	Max. 5,000 m
AC Adaptor	Input	AC100 to 240 V, 50/60 Hz, Max. 1.5 A
Battery Pack	Type	Rechargeable Lithium Ion
	Output	Approx. DC14.4V / 6,380 mAh
	Capacity	Approx. 300 splice and heat cycles
	Temperature	Recharge: 0 to 30°C Storage: -20 to 30°C
	Battery Life	Approx. 500 recharge cycles
Display	Recharge Time	Approx. 5-8 hours from empty
	LCD Monitor	TFT 5 inches with touch screen
Illumination	Magnification	200 to 320x
	V-Grooves	LED lamp
Interface	PC	USB2.0 Mini B type
	External Led Lamp	USB2.0 A type, Approx. DC5V, 500 mA
	Ribbon Stripper	Mini DIN 6 pin, DC12V, Max. 1A
	Wireless	Bluetooth 4.1 LE
Data Storage	Splice Mode	100 splice modes
	Heat Mode	30 heat modes
	Splice Result	20,000 splices
	Splice Image	100 images
Screw Hole For Tripod		1/4-20 UNC
Other Features	Automatic Functions	Splice mode select by fiber type analysis
		Discharge power calibration
		Wind protector: open/close
		Sheath clamp: open
		Heater lid: open/close
Reference Guide	Sheath Clamp	Heater clamp: open/close
		Video and PDF file stored in splicer
		Easy sleeve positioning clamp
Electrode		Replaceable without tool



45S

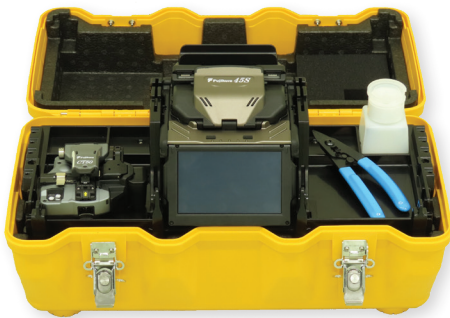

45S Standard Kit



45S on Tripod

## Fujikura 45S Fusion Splicer

The 45S cladding alignment fusion splicer is changing the way people splice fiber in small to mid-fiber count applications. This Fujikura splicer debuts a landmark improvement to the fusion splicing process with the ability to prepare and load both fibers simultaneously. The hand-held fiber coating stripper, the SS-05, is capable of stripping two 250 µm coated fibers in the same pass, along with the CT-16A cleaver adapter plate which can likewise accommodate two bare fibers for cleaving. After preparation, the 45S patented sheath clamps enable loading both fibers simultaneously into the splicer with one fiber in each hand. The user can press down on the sheath clamp base to close it while positioning the fiber in the v-grooves. This enables one-handed operation.

Furthermore, the 45S sheath clamps are mechanically linked to the wind protector, so after splicing is finished, opening the wind protector also opens both sheath clamps for quick sleeve positioning and transfer to the tube heater. The 45S tube heater shrinks sleeves much faster than its predecessor with a nominal ~20 second heat time for 60 mm sleeves down from ~26 seconds. The simultaneous fiber preparation capability, automated sheath clamp opening, and a faster tube heater, combine to lower the overall fusion splicing cycle time by ~30% or more.

The 45S continues to benefit the user experience with improvements to fiber placement, battery access, and machine ergonomics. Previously, when using sheath clamps, if the cleaved fiber was accidentally set past the electrode centerline, the machine would send an error and require manual intervention. The 45S will now accept this mistake and reverse the fiber to correct position automatically. With a cube form factor, the 45S is easily transported and operated in space-constrained environments. The adjustable screen can alleviate glare from the sun and adjust with abnormal splicer positions confronted in challenging splice locations.

Backed by the best service team in the industry, the Fujikura 45S is the ideal splicer to use when portability, ruggedness, speed, and reliability are needed. If you'd like to see the 45S capabilities first-hand, please contact us at 1-800-235-3423 to arrange a product demonstration at your earliest convenience.

### Applications

- 5G Small Cell Site
- FTTx drops and terminations
- MDF/IDF splices and terminations
- Rural fiber deployments and restorations

### Features

- Simultaneous fiber preparation with newly patented sheath clamp design
- Sheath clamps automatically opened with the wind protector
- Automatic fiber placement correction
- Active Fusion Control for arc optimization with every splice
- Active Blade Management for cleave quality monitoring and correction
- Easy-access battery, screen position adjustments, and ergonomic adaptations
- Fully ruggedized for shock, moisture and dust resistance

## Fujikura 45S Fusion Splicer

### Features

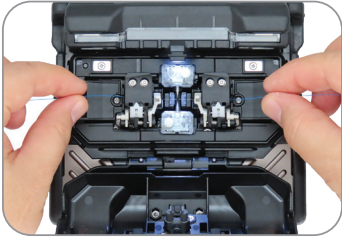

Simultaneous Fiber Loading

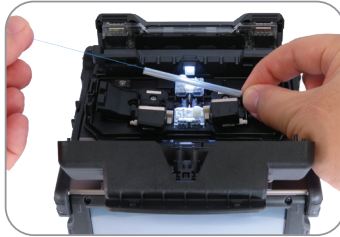

Sleeve Positioning

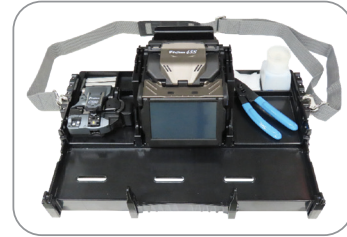

Work Tray with Neck Strap

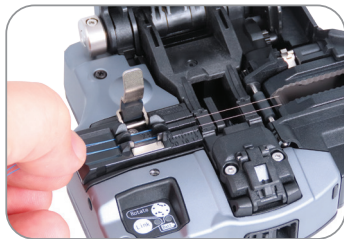

CT-16A Adapter Plate on CT-50

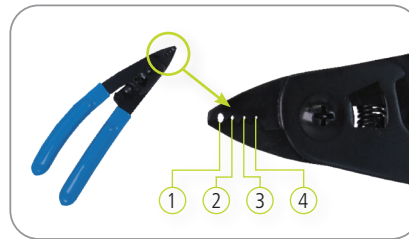

Fiber stripper SS-05

- ① For 2.3 mm
- ② For 900  $\mu$ m
- ③ For 250  $\mu$ m
- ④ For 250  $\mu$ m

### Ordering Information

DESCRIPTION	AFL NO.
<b>Fujikura 45S Standard Kit</b> <b>Includes:</b> CT-50 cleaver, SS-05 single fiber stripper, 1 pair each FH-70-250 and FH-70-900 fiber holders, SP-04 set plates, ELCT2-16B Spare Electrodes (Pair), ADC-21 AC Adapter, BTR-17 Battery Pack (installed), ACC-09 Power Cord, USB-01 USB Cable, AP-02 Alcohol Container, WT-10 work tray, ST-03 carrying case strap, TS-03 tripod screw, CC-45 Transit Case, 1 year factory warranty, and instruction manual downloaded from splicer	S018318
<b>Fujikura 45S Kit without Cleaver</b> <b>Includes:</b> SS-05 single fiber stripper, 1 pair each FH-70-250 and FH-70-900 fiber holders, SP-04 set plates, ELCT2-16B Spare Electrodes (Pair), ADC-21 AC Adapter, BTR-17 Battery Pack (installed), ACC-09 Power Cord, USB-01 USB Cable, AP-02 Alcohol Container, WT-10 work tray, ST-03 carrying case strap, TS-03 tripod screw, CC-45 Transit Case, 1 year factory warranty, and instruction manual downloaded from splicer	S018319
One Year Extended Warranty	S012996
Two Year Extended Warranty	S013000

### Recommended Accessories

DESCRIPTION	AFL NO.
<b>Cleavers AND STRIPPERS</b>	
CT-50 Fiber Cleaver	S017030
CT-16 Fiber Cleaver	S018330
SS-05 Dual Fiber Stripper	S018327
<b>Fiber Holders</b>	
CLAMP-S35B Loose Buffer Sheath Clamp	S018333
FH-70-250 (250 $\mu$ m single fiber)	S017111
FH-70-200 (200 $\mu$ m single fiber)	S017711
FH-70-900 Fiber Holders (900 $\mu$ m single fiber)	S017113
FH-60-LT900 (900 $\mu$ m loose buffer tube)	S015181
<b>FUSEConnect® Accessories</b>	
FH-FC-20 (900 $\mu$ m within 2.0 mm sheathing) (each)	S014696
FH-FC-30 (900 $\mu$ m within 3.0 mm sheathing) (pair)	S014695
FH-FC-900 (900 $\mu$ m cable) (each)	S014697
CLAMP-FC-2000 (pair)	S014705
CLAMP-FC-3000 (pair)	S014704

DESCRIPTION	AFL NO.
<b>Power Supply Options</b>	
BTR-17 Battery Pack	S018324
ADC-21 AC Adapter	S018168
ACC-09 Power Cord	S014390
<b>Miscellaneous</b>	
WT-10 Work Tray	S018336
TS-03 Tripod Screw	S017524
ST-03 Carrying Case and Work Tray Strap	S017549
CLAMP-DC-12 drop cable clamp on work tray	S017550
ELCT2-16B Electrodes	S017103
CC-45 Transit Case	S018326
Splicer V-Groove Cleaning Kit	S014397
USB-01 USB Cable	S014777
SP-04 Fiber Holder Set Plates	S018332
AD-16A Adapter Plate (CT-50 and CT-16 up to 900 $\mu$ m)	S018328
Portable Tripod Workstation (see web listing for more detail)	S014773



## Fujikura 45S Fusion Splicer

### Specifications

PARAMETER		VALUE
Fiber alignment method		Active cladding alignment
Fiber count can be spliced		Single fiber
Applicable fiber	Fiber type	Single-mode optical fiber Multimode optical fiber
	Cladding dia.	Approx. 125 μm
Applicable coating	Sheath Clamp	Coating diameter: Max. 3,000 μm Cleave length: 5 to 16 mm <sup>*1</sup>
	Fiber Holder	Coating diameter: 160 μm – 3,000 μm based on available fiber holder options Cleave length: Approx. 10 mm
Fiber splice performance	Splice loss <sup>*2</sup>	ITU-T G.652: Avg. 0.03dB
		ITU-T G.651: Avg. 0.01dB
ITU-T G.653: Avg. 0.05dB		
ITU-T G.655: Avg. 0.05dB		
ITU-T G.657: Avg. 0.03dB		
Splicing time <sup>*3</sup>	SM FAST mode: Avg. 6 to 7 sec.	
	SM AUTO mode: Avg. 8 to 10 sec.	
Applicable protection sleeve	Sleeve type	Heat shrinkable sleeve
	Sleeve length	Max. 66 mm
	Sleeve dia.	Max. 6.0 mm before shrinking
Sleeve heat performance	Heat time <sup>*4</sup>	60 mm mode: Avg. 15 to 22 sec.
		60 mm slim mode: Avg. 15 to 17sec.
Fiber tensile test force		Approx. 2.0 N
Electrode life <sup>*5</sup>		Approx. 6,000 splices
Physical description	Dimensions W	Approx. 131 mm without projection
	Dimensions D	Approx. 123 mm without projection
	Dimensions H	Approx. 121 mm without projection
	Weight	Approx. 1.4 kg including battery
Environmental condition	Temperature	Operate : -10 to 50°C Storage : -40 to 80°C
	Humidity	Operate : 0 to 95% non-condensing Storage : 0 to 95% non-condensing
	Altitude	Max. 5,000 m
AC adaptor	Input	AC100 to 240V, 50/60Hz, Max. 1A
	Output	Approx. DC 19V, Max. 2.1A
Battery pack	Type	Rechargeable Lithium Ion
	Output	Approx. DC 14.4V / 3,190mAh
	Capacity <sup>*6</sup>	60 mm heat mode: Approx. 200 splice & heat cycles
		60 mm slim heat mode: Approx. 230 splice & heat cycles
	Temperature	Operate: -10 to 50°C
Recharge : 0 to 40°C		
Short term storage of 30 days: -20 to 50°C Long term storage: -20 to 30°C		
Battery life <sup>*7</sup>	Approx. 500 recharge cycles	
Display	LCD monitor	TFT 4.95 inches with touch screen
	Magnification	Approx. 132 to 300X
Illumination	V-grooves	LED lamp
Interface	PC	USB2.0 MINI B type
	External LED lamp	USB 2.0 A type
		Approx. DC5V, 500mA
Wireless <sup>*8</sup>	Bluetooth® 5.2	



## Fujikura 45S Fusion Splicer

### Specifications

PARAMETER		VALUE
Data storage	Splice mode	100 splice modes
	Heat mode	30 heat modes
	Splice result	20,000 splices
	Fiber image	100 images
Screw hole for tripod		1/4-20UNC
Other features	Automatic functions	Fusion control
		Blade management and control
		Splice start
		Heater start
	Reference guide	PDF file stored on splicer
	Sheath clamp	Open with/without wind protector
		Close when setting fiber
		Easy sleeve positioning design
	Electrode	Tool-less replacement
	PC Software	Splicer firmware update via internet
Parameter Upload and download		

#### NOTES:

- \*1 Cleave length range depending on fiber type
  - 5 – 16 mm: 125 μm cladding dia. And 250 μm coating dia.
  - 10 – 16 mm: 125 μm cladding dia. And 400 or 900 μm coating dia.
- \*2 Measured with cut-back method relevant to ITU-T and IEC standard after splicing Fujikura identical fibers. The average splice loss changes depending on the environmental condition and fiber characteristics.
- \*3 Measured at room temperature. The definition of splice time is from the fiber image appearing on the LCD monitor to the estimated splice loss. The average splice time changes depending on the environmental conditions, fiber type, and fiber characteristics.
- \*4 Measured at room temperature with the AC adapter. The heat time is defined from the start beep sound to the finish beep sound. The average heat time changes depending on the environmental conditions, sleeve type, and battery pack condition. In addition, since the heating operation is constantly optimized, the average heating time changes depending on the usage conditions of the fusion splicer.
- \*5 The electrode life changes depending on the environmental conditions, fiber type, and splice modes used.
- \*6 Test Conditions
  - Splice and heat time: 1 minute cycle
  - Using the splicer power save settings, subject to our testing condition
  - Using a new battery
  - Room temperature
  - The battery capacity changes when testing in different conditions than above
- \*7 The battery capacity decreases to half after approx. 500 discharge and recharge cycles. The battery life is shortened further when using outside of the storage and operating temperature ranges, or if completely discharged when stored for an extended period without recharging.
- \*8 Bluetooth mark and logos are registered trademarks of Bluetooth SIG, Inc.



35S



35S Standard Kit



CT-16 with AD-16A Adapter

## Fujikura 35S Fusion Splicer

The 35S cladding alignment fusion splicer is changing the way people splice fiber in small to mid-fiber count applications. This Fujikura splicer debuts a landmark improvement to the fusion splicing process with the ability to prepare and load both fibers simultaneously. The hand-held fiber coating stripper, the SS-05, is capable of stripping two 250 μm coated fibers in the same pass, along with the CT-16 cleaver adapter plate which can likewise accommodate two bare fibers for cleaving. After preparation, the 35S patented sheath clamps enable loading both fibers simultaneously into the splicer with one fiber in each hand. The user can press down on the sheath clamp base to close it while positioning the fiber in the v-grooves. This enables a one-handed operation.

Furthermore, the 35S sheath clamps are mechanically linked to the wind protector, so after splicing is finished, opening the wind protector also opens both sheath clamps for quick sleeve positioning and transfer to the tube heater. The 35S tube heater shrinks sleeves much faster than its predecessor with a nominal ~20 second heat time for 60 mm sleeves down from ~26 seconds. The simultaneous fiber preparation capability, automated sheath clamp opening, and a faster tube heater, combine to lower the overall fusion splicing cycle time by ~30% or more.

The 35S continues to benefit the user experience with improvements to fiber placement, battery access, and machine ergonomics. Previously, when using sheath clamps, if the cleaved fiber was accidentally set past the electrode centerline, the machine would send an error and require manual intervention. The 35S will now accept this mistake and reverse the fiber to correct position automatically. With a cube form factor, the 35S is easily transported and operated in space-constrained environments. The adjustable screen can alleviate glare from the sun and adjust with abnormal splicer positions confronted in challenging splice locations.

Backed by the best service team in the industry, the Fujikura 35S is the ideal splicer to use when portability, ruggedness, speed, and reliability are needed. If you'd like to see the 35S capabilities first-hand, please contact us at 1-800-235-3423 to arrange a product demonstration at your earliest convenience.

### Features

- Simultaneous fiber preparation with patented sheath clamp design.
- Sheath clamps automatically opened with the wind protector.
- Automatic fiber placement correction.
- Active Fusion Control for arc optimization with every splice.
- Easy-access battery, screen position adjustments, and ergonomic adaptations.
- Fully ruggedized for shock, moisture, and dust resistance.

### Applications

- 5G Small Cell Site
- FTtx drops and terminations
- MDF/IDF splices and terminations
- Rural fiber deployments and restorations

## Fujikura 35S Fusion Splicer

### Features

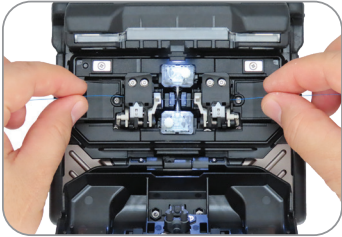

Simultaneous Fiber Loading

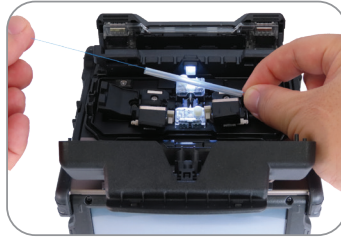

Sleeve Positioning

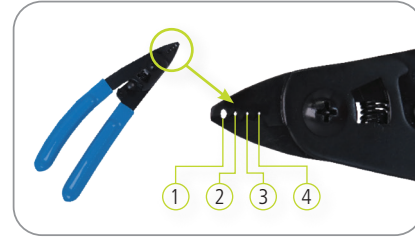

Fiber stripper SS-05

- ① For 2.3 mm
- ② For 900 μm
- ③ For 250 μm
- ④ For 250 μm

### Ordering Information

DESCRIPTION	AFL NO.
<b>Fujikura 35S Standard Kit</b> <b>Includes:</b> CT-16 cleaver, SS-05 single fiber stripper, 1 pair each FH-70-250 and FH-70-900 fiber holders, SP-04 set plates, ELCT2-16B Spare Electrodes (Pair), ADC-21 AC Adapter, BTR-17 Battery Pack (installed), ACC-09 Power Cord, USB-01 USB Cable, CC-44 Transit Case, 1 year factory warranty and instruction manual downloaded from splicer	S018314
<b>Fujikura 35S Kit without Cleaver</b> <b>Includes:</b> SS-05 single fiber stripper, 1 pair each FH-70-250 and FH-70-900 fiber holders, SP-04 set plates, ELCT2-16B Spare Electrodes (Pair), ADC-21 AC Adapter, BTR-17 Battery Pack (installed), ACC-09 Power Cord, USB-01 USB Cable, 1 year factory warranty and instruction manual downloaded from splicer	S018316
One Year Extended Warranty	S012996
Two Year Extended Warranty	S013000

### Recommended Accessories

DESCRIPTION	AFL NO.
<b>Cleavers AND STRIPPERS</b>	
CT-50 Fiber Cleaver	S017030
CT-16 Fiber Cleaver	S018330
SS-05 Dual Fiber Stripper	S018327
<b>Fiber Holders</b>	
CLAMP-S35B Loose Buffer Sheath Clamp	S018333
FH-70-250 (250 μm single fiber)	S017111
FH-70-200 (200 μm single fiber)	S017711
FH-70-900 Fiber Holders (900 μm single fiber)	S017113
FH-60-LT900 (900 μm loose buffer tube)	S015181
<b>FUSEConnect® Accessories</b>	
FH-FC-20 (900 μm within 2.0 mm sheathing) (each)	S014696
FH-FC-30 (900 μm within 3.0 mm sheathing) (pair)	S014695
FH-FC-900 (900 μm cable) (each)	S014697
CLAMP-FC-2000 (pair)	S014705
CLAMP-FC-3000 (pair)	S014704

DESCRIPTION	AFL NO.
<b>Power Supply Options</b>	
BTR-17 Battery Pack	S018324
ADC-21 AC Adapter	S018168
ACC-09 Power Cord	S014390
<b>Miscellaneous</b>	
TS-03 Tripod Screw	S017524
ELCT2-16B Electrodes	S017103
CC-44 Transit Case	S018325
Splicer V-Groove Cleaning Kit	S014397
USB-01 USB Cable	S014777
SP-04 Fiber Holder Set Plates	S018332
AD-16A Adapter Plate (CT-50 & CT-16 up to 900um)	S018328
AD-16B Adapter Plate (CT-50 & CT-16 up to 3mm)	S018331
CB-09 Replacement Blade for CT-16 Cleaver	S018335
Portable Tripod Workstation (see web listing for more detail)	S014773

## Fujikura 35S Fusion Splicer

### Specifications

PARAMETER		VALUE
Fiber alignment method		Active cladding alignment
Fiber count can be spliced		Single fiber
Applicable fiber	Fiber type	Single mode optical fiber Multi mode optical fiber
	Cladding dia.	Approx. 125 μm
Applicable coating	Sheath Clamp	Coating diameter: Max. 3,000 μm Cleave length: 5 to 16 mm *1
	Fiber Holder	Coating diameter: 160 μm – 3,000 μm based on available fiber holder options Cleave length: Approx. 10 mm
Fiber splice performance	Splice loss *2	ITU-T G.652: Avg. 0.03dB
		ITU-T G.651: Avg. 0.01dB
ITU-T G.653: Avg. 0.05dB		
ITU-T G.655: Avg. 0.05dB		
ITU-T G.657: Avg. 0.03dB		
Splicing time*3	SM FAST mode: Avg. 6 to 7 sec.	
	SM AUTO mode: Avg. 8 to 10sec.	
Applicable protection sleeve	Sleeve type	Heat shrinkable sleeve
	Sleeve length	Max. 66 mm
	Sleeve dia.	Max. 6.0 mm before shrinking
Sleeve heat performance	Heat time*4	60 mm mode: Avg. 15 to 22sec.
		60 mm slim mode: Avg. 15 to 17sec.
Fiber tensile test force		Approx. 2.0 N
Electrode life*5		Approx. 6,000 splices
Physical description	Dimensions W	Approx. 131 mm without projection
	Dimensions D	Approx. 123 mm without projection
	Dimensions H	Approx. 121 mm without projection
	Weight	Approx. 1.4 kg including battery
Environmental condition	Temperature	Operate : -10 to 50°C Storage : -40 to 80°C
	Humidity	Operate : 0 to 95% non-condensing Storage : 0 to 95% non-condensing
	Altitude	Max. 5,000 m
AC adaptor	Input	AC100 to 240V, 50/60Hz, Max. 1A
	Output	Approx. DC 19V, Max. 2.1A
Battery pack	Type	Rechargeable Lithium Ion
	Output	Approx. DC 14.4V / 3,190mAh
	Capacity*6	60 mm heat mode: Approx. 200 splice & heat cycles
		60 mm slim heat mode: Approx. 230 splice & heat cycles
	Temperature	Operate: -10 to 50°C
Recharge : 0 to 40°C		
Short term storage of 30 days: -20 to 50°C Long term storage: -20 to 30°C		
Battery life*7	Approx. 500 recharge cycles	
Display	LCD monitor	TFT 4.95 inches with touch screen
	Magnification	Approx. 132 to 300X
Illumination	V-grooves	LED lamp
Interface	PC	USB 2.0 MINI B type
	External LED lamp	USB 2.0 A type Approx. DC5V, 500mA

## Fujikura 35S Fusion Splicer

### Specifications

PARAMETER		VALUE
Data storage	Splice mode	100 splice modes
	Heat mode	30 heat modes
	Splice result	20,000 splices
	Fiber image	100 images
Other features	Automatic functions	Fusion control
		Splice start
		Heater start
	Reference guide	PDF file stored on splicer
	Sheath clamp	Open with/without wind protector
		Close when setting fiber
	Electrode	Easy sleeve positioning design
		Tool-less replacement
PC Software	Splicer firmware update via internet	
	Parameter Upload and download	

#### NOTES:

- \*1 Cleave length range depending on fiber type  
 5 – 16 mm: 125 μm cladding dia. And 250 μm coating dia.  
 10 – 16 mm: 125 μm cladding dia. And 400 or 900 μm coating dia.
- \*2 Measured with cut-back method relevant to ITU-T and IEC standard after splicing Fujikura identical fibers. The average splice loss changes depending on the environmental condition and fiber characteristics.
- \*3 Measured at room temperature. The definition of splice time is from the fiber image appearing on the LCD monitor to the estimated splice loss. The average splice time changes depending on the environmental conditions, fiber type, and fiber characteristics.
- \*4 Measured at room temperature with the AC adapter. The heat time is defined from the start beep sound to the finish beep sound. The average heat time changes depending on the environmental conditions, sleeve type, and battery pack condition. In addition, since the heating operation is constantly optimized, the average heating time changes depending on the usage conditions of the fusion splicer.
- \*5 The electrode life changes depending on the environmental conditions, fiber type, and splice modes used.
- \*6 Test Conditions  
 Splice and heat time: 1 minute cycle  
 Using the splicer power save settings, subject to our testing condition  
 Using a new battery  
 Room temperature  
 The battery capacity changes when testing in different conditions than above
- \*7 The battery capacity decreases to half after approx. 500 discharge and recharge cycles. The battery life is shortened further when using outside of the storage and operating temperature ranges, or if completely discharged when stored for an extended period without recharging.



 Bluetooth®

90R

## Fujikura 90R Fusion Splicer

The Fujikura 90R is the mass fusion splicer workhorse of the splicing world. As data demand continues to rise, the solution to handle the increased traffic is to increase fiber counts. As a result, fiber counts being utilized in enterprise data centers, campus, and metro networks have grown enough to make single fiber splicing too costly and timely. High density cabling made possible by SpiderWeb Ribbon® (SWR®) and others like it are spurring ribbon splicing activity in places that have traditionally used loose fiber. The 90R is the answer to these changes in splicing demand. With automated splice start, tube heater, wind protector, cleave tracking, and blade rotations for up to 2 cleavers at a time, this splicer frees up operator time for other fiber preparation steps. New to the 90R, you can keep your splicer in the field longer with field replaceable V-grooves. When V-grooves can no longer be cleaned after extended use, or are accidentally damaged, you can resume splicing in minutes by installing the spare set included with your 90R kit. Put our 90R to the test by contacting us to see its capabilities first-hand, 1-800-235-3423.



In Work Tray

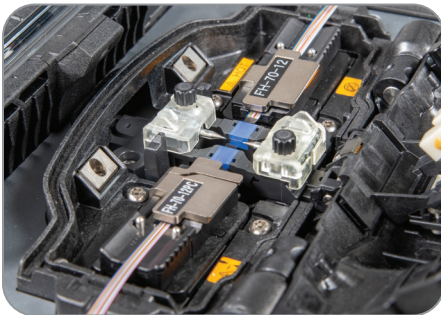

Wind Protector Open

### Features

- Cleave tracking and upkeep with wireless communication
- Automated wind protector, tube heater and splice operation
- User replaceable v-grooves
- 200 μm and 250 μm SWR universal ribbon prep accessories
- Graphical User Interface with 5.0" Touchscreen
- PC software and 90R manual downloaded from splicer
- Multi-function transit case with integrated workstation

### Applications

- Data Center cable installation
- High fiber count metro and campus networks
- Long-haul network installs and repair
- Trunk cable repair with Splice-on MPOs
- Ribbon splicing high density cables with 200 μm loose fiber



## Fujikura 90R Fusion Splicer

### Ordering Information

DESCRIPTION	AFL NO.
<b>90R Fusion Splicer (machine only)</b> <b>Includes:</b> BTR-15 Battery, ADC-20 AC Adapter, ACC-14 AC Cord, ELCT2-16B Spare Electrodes (pair) with spare V-Grooves (VG12-01), FH-70-12 Fiber Holders (pair), USB Cable, Alcohol Dispenser, Splicer Carrying Strap, Quick Reference Guide, TS-03 Tripod Screw, Video Instruction Manual, Work Tray, CC-39 Transit Case with Carrying Strap and Two Year Warranty	S017509
<b>90R Fusion Splicer Kit (with cleaver &amp; thermal stripper)</b> <b>Includes:</b> BTR-15 Battery, CT50 Cleaver, RS03 Stripper, ADC-20 AC Adapter, ACC-14 AC Cord, ELCT2-16B Spare Electrodes (pair) with spare V-Grooves (VG12-01), FH-70-12 Fiber Holders (pair), USB Cable, Alcohol Dispenser, Splicer Carrying Strap, Quick Reference Guide, TS-03 Tripod Screw, Video Instruction Manual, CC-39 Transit Case with Carrying Strap and Two Year Warranty	S017511
<b>90R Fusion Splicer without Bluetooth (machine only)</b> <b>Includes:</b> BTR-15 Battery, ADC-20 AC Adapter, ACC-14 AC Cord, ELCT2-16B Spare Electrodes (pair) with spare V-Grooves (VG12-01), FH-70-12 Fiber Holders (pair), USB Cable, Alcohol Dispenser, Splicer Carrying Strap, Quick Reference Guide, TS-03 Tripod Screw, Video Instruction Manual, CC-39 Transit Case with Carrying Strap and Two Year Warranty	S017540
<b>90R Fusion Splicer Kit without Bluetooth (with cleaver &amp; thermal stripper)</b> <b>Includes:</b> BTR-15 Battery, CT50 Cleaver, RS01 Stripper, ADC-20 AC Adapter, ACC-14 AC Cord, ELCT2-16B Spare Electrodes (pair) with spare V-Grooves (VG12-01), FH-70-12 Fiber Holders (pair), USB Cable, Alcohol Dispenser, Splicer Carrying Strap, Quick Reference Guide, TS-03 Tripod Screw, Video Instruction Manual, CC-39 Transit Case with Carrying Strap and Two Year Warranty	S017510
One Year Extended Warranty	S012996
Two Year Extended Warranty	S013000

### Recommended Products for the 90R

DESCRIPTION	AFL NO.
<b>Cleavers and Strippers</b>	
CT50 Cleaver	S017030
RS01 Thermal Stripper	S016815
RS02 Thermal Stripper	S016816
RS03 Thermal Stripper	S016817
<b>Fiber Holders (pair)</b>	
FH-70-2	S017114
FH-70-4	S017115
FH-70-6	S017116
FH-70-8	S017117
FH-70-10	S017118
FH-70-12	S017119
FH-70-12PC (pitch conversion holder for 200 µm loose fibers)	S017464
FH-70-12-200 (200 µm pitch ribbons)	S017681
FH-70-16	S017533
FH-70-250 (250 µm coated single fiber)	S017111
FH-70-900 (900 µm jacketed single fiber)	S017113
FH-60-LT900 (Loose buffer 900 µm fiber)	S015181
<b>FUSEConnect® Accessories</b>	
FH-FC-20 (900 µm within 2.0 mm sheathing) (each)	S014696
FH-FC-30 (900 µm within 3.0 mm sheathing) (pair)	S014695
FH-FC-900 (900 µm cable) (each)	S014697
CLAMP-FC-2000 (pair)	S014705
<b>Batteries and Power Cords</b>	
ADC-20 AC Adapter	S017513
BTR-15 Battery	S017512
DCC-11 splicer to ribbon stripper power cord	S013852
DCC-20 Power Cord	S017527
Connects ADC-20 to cigarette lighter socket	
DCC-21 Power Cord	S017528
Connects ADC-20 to power source via alligator clips	
ACC-14 AC Power Cord	S014536

DESCRIPTION	AFL NO.
<b>Miscellaneous</b>	
SS01 Single fiber stripper (1 hole)	S017099
ELCT2-16B Electrodes	S017103
Portable Tripod Workstation (see product profile for more detail)	S014773
ASW-02 Splicing Workstation (see product profile for more detail)	S010532
WT-09R Work Tray Right	S017515
WT-09L Work Tray Left	S017516
JP-09 Work Tray J-Plate	S017517
JP-10 J-Plate (Cooling tray attaches to splicer)	S017522
JP-10-FC J-Plate with Fiber Clamps	S017523
TS-03 Tripod Screw (90 Series)	S017524
ST-02 Fusion Splicer Strap	S017525
CLAMP-DC-12 (Drop Cable clamp on work tray)	S017550
FST-12 Fiber Separation Tool	S014012
FAT-04 Fiber Arrangement Tool	S010212
RT-02 Fiber Arrangement Tool	S017465
VG12-01 12 fiber V-groove	S017548
VG12-01-200 12 fiber V-groove (200µm pitch ribbons)	S017680
VG04-01 4 fiber V-groove	S017551
VG08-01 Spare 8 fiber V-grooves	S017508
VG16-01 16 fiber V-groove	S017552
FAA-03A Ribbon Forming Adhesive (4 oz. bottle)	S008720
FAA-03A Ribbon Forming Adhesive (0.5 liter bottle)	S008622
CC-39 Transit Case	S017514
Splicer V-Groove Cleaning Kit	S014397
TS-03 Case and Work Tray Strap	S017549



#### Fiber Arrangement Tool

- Features an easy-to-use fiber arrangement method utilizing linear travel
- Includes a spare paste applicator



#### V-Groove Cleaning Kit

- Removes environmental contamination from the v-groove of the splicer
- Maintains performance and ensures fiber alignment

## Fujikura 90R Fusion Splicer

### Specifications

PARAMETER	VALUE	
Fiber Alignment Method	Self cladding alignment with melting surface tension	
Fiber Count Can Be Spliced	Up to 16 fiber ribbon	
Applicable Fiber	Fiber Type	Single mode optical fiber Multi mode optical fiber
	Cladding Dia.	Approx. 125 μm
Applicable Coating	Fiber Holder	Coating shape. : Refer to fiber holder options Cleave length : 10 mm
Fiber Splice Performance	Splice Loss	ITU-T G.652 : Avg. 0.05 dB
		ITU-T G.651 : Avg. 0.02 dB
ITU-T G.653 : Avg. 0.08 dB		
ITU-T G.655 : Avg. 0.08 dB		
ITU-T G.657 : Avg. 0.05 dB		
Splice Time	SM FAST mode : Avg. 14 to 15 sec.	
	SM AUTO mode : Avg. 19 to 20 sec.	
Applicable Protection Sleeve	Sleeve Type	Heat-shrinkable sleeve
	Sleeve Length	Max. 66 mm
	Sleeve Dia.	Max. 6.0 mm before shrinking
Sleeve Heat Performance	Heat Time	40 mm FP-05 mode : Avg. 38 to 40 sec.
		40 mm FP-04T mode : Avg. 17 to 19 sec.
		Single 60 mm mode: Avg. 13 to 15 sec.
Fiber Tensile Test Force	Approx. 2.0 N	
Electrode Life	Approx. 1,500 splices	
Physical Description	Dimensions W	Approx.170 mm without projection
	Dimensions D	Approx.173 mm without projection
	Dimensions H	Approx.150 mm without projection
	Weight	Approx. 2.6 kg including battery
Environmental Condition	Temperature	Operate : -10 to 50°C
		Storage : -40 to 80°C
	Humidity	Operate : 0 to 95% RH non-condensing
Storage : 0 to 95% RH non-condensing		
Altitude	Max. 3,700 m	
Ac Adaptor	Input	AC100 to 240 V, 50/60 Hz, Max. 1.5 A
Battery Pack	Type	Rechargeable Lithium Ion
	Output	Approx. DC14.4V / 6,380 mAh
	Capacity	Approx. 165 splice and heat cycles
	Temperature	Recharge : 0 to 30°C
		Storage : -20 to 30°C
	Battery Life	Approx. 500 recharge cycles
Recharge Time	Approx. 5 – 8 hours from empty	
Display	LCD Monitor	TFT 5 inches with touch screen
	Magnification	Approx. 20X : 12 Ribbon to 60X : Single
Illumination	V-Grooves	LED lamp
Interface	PC	USB2.0 Mini B type
	External Led Lamp	USB2.0 A type, Approx. DC5V, 500 mA
	Ribbon Stripper	Mini DIN 6 pin, DC12V, Max. 1A
	Wireless	Bluetooth 4.1 LE
Data Storage	Splice Mode	100 splice modes
	Heat Mode	30 heat modes
	Splice Result	10,000 splices
	Splice Image	100 images
Screw Hole For Tripod		1/4-20 UNC
Other Features	Automatic Functions	Splice mode select by fiber type analysis
		Discharge power calibration
		Wind protector : open/close
		Sheath clamp : open
	Heater lid : open/close	
Heater clamp : open/close		
Reference Guide	Video and PDF file stored in splicer	
Electrode	Replaceable without tool	



Bluetooth



Shown in CC-37 Carrying Case

### Features

- Motorized blade rotation
- Bluetooth communication
- Shock resistant
- Simple one-step operation
- 60,000 cleave blade life
- Field serviceable



## CT50 Fiber Cleaver

The CT50 features automated blade rotation, unprecedented durability, and simplistic maintenance unseen with any other cleaver. Paired with a Bluetooth enabled Fujikura splicer, cleaver blade positions can be automatically advanced when needed based on cleave count or cleave quality. If automated rotation is not desired, the blade position can be advanced at the touch of a button, no tools required. The easy to read blade position indicator clearly displays the selected position. The Bluetooth® feature, along with simplified mechanical operation, increases overall productivity and reliability. The fiber clamp opens beyond 90 degrees and readies the blade for cleaving in the same motion. This allows easy viewing of the distance scale used to gauge cleave length. The 16-position blade yields 60,000 single-fiber cleaves, or 5,000 12-fiber ribbon cleaves. The built-in scrap collector conveniently stores fiber shards until they can be safely discarded.

The CT50 is an industry first cleaver ruggedized to withstand severe shock, including drops up to 30 inches. If needed, the CT50 is field serviceable with all precision components easily replaced in the field.

### Specifications

ITEM	VALUE	
Applicable Fiber	Fiber type	Single-mode optical fiber
	Fiber count	Multimode optical fiber
	Cladding dia.	Single up to 16 fibers
Applicable Coating	Fiber plate	Approx. 125 μm
	Fiber holder	AD-10-M24 : Max. 900 μm coating diameter AD-50 : Max. 3 mm coating diameter
Cleave Length	Fiber plate	FH- 50, FH-60, FH-70, FH-100 and FH-110 series holders
	Fiber holder	AD-10-M24 : 5 to 20 mm for CD ≤ 250 μm AD-50 [CD = coating diameter] CD= 250μm or less : 5 to 20 mm 250 μm < CD < 1000μm : 10 to 20 mm 1000 μm < CD < 3 mm : 14 to 20 mm
Cleave Angle	Single fiber	Approx. 10 mm
	Fiber ribbon	Avg. 0.3 to 0.9 degrees
Blade Life		Avg. 0.3 to 1.2 degrees
Physical description	Dimensions W	Approx. 60,000 fiber cleaves
	Dimensions D	Approx. 120 mm when closing the lever
	Dimensions H	Approx. 95 mm when closing the lever
	Weight	Approx. 58 mm when closing the lever
Environmental condition	Temperature	Approx. 305 g including battery and AD-10-M24
	Humidity	Operate : -10 to 50°C Storage : -40 to 80°C
Battery		Operate : 0 to 95% non-condensing Storage : 0 to 95% non-condensing
Wireless interface <sup>1</sup>		2 pieces of LR03/AAA dry battery
Screw hole for tripod		Bluetooth 4.1 LE
Other features	Blade rotation	1/4-20UNC
	Replaceable parts	Motorized rotation
		Manual rotation dial
	Blade	
	Clamp arm	

1. The CT50 No Bluetooth option has the wireless interface permanently disabled.

continued  
→

## CT50 Fiber Cleaver

### Ordering Information

DESCRIPTION	APPLICATION	FIBER HANDLING SYSTEM	CLEAVE LENGTH	AFL NO.
CT50	Single or Ribbon Fiber	AD-10-M24 adapter plate for single fibers or fiber holders for ribbons	See Specifications table on previous page	S017030
CT50 No Bluetooth	Single or Ribbon Fiber	AD-10-M24 adapter plate for single fibers or fiber holders for ribbons	See Specifications table on previous page	S018020

### Accessories

DESCRIPTION	AFL NO.
CB-08 Replacement Blade	S017076
FDB-05 Scrap Collector Box	S017121
AD-50 Adapter Plate	S017010
AD-10-M24 Fiber Plate	S017335
ARM-CT50-01 Replacement Arm Set	S017122
BRW-CT08-01 Blade Rotary Wheel	S017110
SC-CT50-01 Side Cover	S017108
CC-37 Transit Case	S017077
SPA-CT-08-10 Spacer	S017011

**Splice+** is a smartphone application that works in cooperation with Fujikura's splicers, cleavers and ribbon fiber strippers which have Bluetooth capability.

Get the **Splice+** app at the Apple App store or at Google Play.





## CT16 Fiber Cleaver

The CT16 fiber cleaver from Fujikura was designed for FTTH or other space constrained applications where ergonomics and durability are key. It is compact, can be operated ambidextrously, and features a unique fiber adapter, allowing users to cleave two bare fibers simultaneously when paired with the dual fiber stripper, the SS-05. The scrap collector and fiber adapter side can be swapped by the user for left or right-handed preference, or as environmental constraints dictate. Furthermore, the thumbwheel on the bottom of the cleaver is utilized for blade rotations as opposed to previous tedious processes to rotate a cleaver blade. The top lever opens past vertical allowing for easy viewing, cleaning, and adjustment of the cleave length. The blade is retracted when the top lever is opened and the blade activates to score the fiber when it is closed, making this a true one-step cleaver. Like its predecessor, this cleaver can withstand a 30" drop from any of six different orientations and still maintain factory specified cleave angle performance. The cleaver blade and fiber clamping mechanisms are easy to replace in the field, mitigating the need to send this cleaver in for service.



### Features

- Dual fiber adapter plate for single or two fiber cleaving
- Ambidextrous operation available
- Field replaceable fiber clamp pads and cleaver blade
- Shock resistant for drops up to 30" in any of six different orientations
- Compact form factor and tool-less blade rotations

### Applications

- Small cell site
- FTTH drops and terminations
- MDF/IDF splices and terminations
- Rural fiber deployments and restorations

### Ordering Information

DESCRIPTION	AFL NO.
<b>CT16 Fiber Cleaver</b> includes: FDB-06 scrap collector, AD-16A fiber adapter, HEX-01 hex wrench (1.5 mm), M-CT16-E instruction manual, CC-46 carrying case	S018330
FDB-06 Scrap Collector	S018329
CB-09 Replacement Cleaver Blade	S018335
ARM-CT16-01 Replacement Fiber Clamp Pads	S018373
AD-16A Fiber Adapter (up to 900um coating)	S018328
AD-16B Fiber Adapter (up to 3.0mm jacket)	S018331
CC-46 Carrying Case	S018374

*continued*  
→

## CT16 Fiber Cleaver

### Specifications

PARAMETER		VALUE
Applicable Fiber	Fiber type	Single-mode optical fiber Multimode optical fiber
	Fiber count	2 single fibers
	Cladding diameter	Approx. 125 $\mu\text{m}$
Applicable Coating	Adapter plate	AD-16A: Max 900 $\mu\text{m}$ coating diameter single fiber or 250 $\mu\text{m}$ coating diameter for two fibers AD-16B: Max. 3 mm jacket diameter
	Fiber holders	FH-60 and FH-70 series – coating diameter dictated by specific fiber holder
Cleave Length	Adapter plate	AD-16A: 5 – 20 mm <sup>*1</sup> AD-16B: Coating diameter – 250 $\mu\text{m}$ or less: 5-20 mm <sup>*1</sup> 251 $\mu\text{m}$ -900 $\mu\text{m}$ : 10-20 mm 901 $\mu\text{m}$ -3 mm: 14-20 mm
	Fiber holder	Approx. 10 mm
Cleave Angle <sup>*2</sup>	Single fiber	Avg. 0.3 to 0.9 degrees
Blade Life <sup>*3</sup>		Approx. 48,000 fiber cleaves
Physical description	Dimensions W	Approx. 106 mm without projection <sup>*4</sup>
	Dimensions D	Approx. 95.5 mm without projection <sup>*4</sup>
	Dimensions H	Approx. 49 mm without projection <sup>*4</sup>
	Weight	Approx. 190 g including AD-16A
Environmental condition	Temperature	Operate: -10 to 50°C Storage: -40 to 80°C
	Humidity	Operate: 0 to 95%RH non-condensing Storage: 0 to 95%RH non-condensing
Other features	Blade rotation	Manual dial underneath cleaver
	Replaceable items	Cleaver blade Fiber clamp pads
	Fiber adapter base and scrap collector	Can be swapped position for ambidextrous operation
	Cleave count	Up to two individual bare fibers

### Notes

1. When the cleave length is less than 10 mm, the coating diameter should be 250  $\mu\text{m}$  or less. Also, a blade height adjustment is required before cleaving. The average cleave angle is worse than the specification above when the cleave length is less than 10 mm.
2. Measured with an interferometer at room temperature, not with a splicer. A new blade was used to cleave the single fibers. The average cleave angle changes depending on the environmental conditions, blade condition, operating method, and cleanliness.
3. The blade life changes depending on the environmental conditions, operating method, and the fiber type cleaved.
4. Measured with the top lever closed.





## Thermal Strippers

The RS01, RS02, RS03 and RS03-80 Thermal Strippers provide superior stripping performance for both single and multi-fiber stripping. The fast heating time of 3 seconds speeds productivity. The ergonomic design, combined with the low level of force needed for stripping, makes the RS series comfortable and easy to use for high fiber count applications. The strippers are also capable of stripping 200 µm coated fibers and ribbons. An audible beep and illuminated LED signal indicate that the proper heating temperature has been reached. A temperature selection switch permits easy field optimization for different fibers or operating conditions. These strippers accept all Fujikura field and factory style fiber holders.

Bluetooth® capabilities on the RS02 and RS03 models provide a convenient way to program the stripper for user preferences via an Android or iOS smartphone app. The RS03 model includes a powerful Lithium-Ion battery that delivers enough power for 600 stripping cycles. The RS03-80 is offered for stripping 80 µm cladding fiber applications.

For those situations and locations where Bluetooth-enabled devices are not permitted, the RS01 model is available with all of the features of the RS02 model but without the Bluetooth technology.

### Features

- 3 Second heating time with beep and LED notification
- Low pulling force needed for stripping
- Stripping capability for 200 µm coated fibers and ribbons
- Ergonomic design
- Bluetooth capable for wireless connection with smartphones (RS02, RS03 and RS03-80)
- High capacity battery provides approximately 600 stripping cycles (RS03 and RS03-80)

### Ordering Information

DESCRIPTION	AFL NO.
<b>Strippers</b>	
<b>RS01 Thermal Stripper</b> Includes: RS01 Thermal Stripper, DCC-11 and Instruction manual	S016815
<b>RS02 Thermal Stripper</b> Includes: RS02 Thermal Stripper, DCC-11, HEX-01 Hex Wrench, BRS-02 Brush and Instruction manual	S016816
<b>RS03 Thermal Stripper</b> Includes: RS03 Thermal Stripper, BTR-12 Battery Pack, ADC-09A AC Adapter for RS Series Thermal Strippers, ACC-09 AC Power Cord (for ADC-09A), HEX-01 Hex Wrench, BRS-02 Brush and Instruction manual	S016817
<b>RS03-80 Thermal Stripper</b> Includes: RS03-80 Thermal Stripper, BTR-12 Battery Pack, ADC-09A AC Adapter for RS Series Thermal Strippers, ACC-09 AC Power Cord (for ADC-09A), HEX-01 Hex Wrench, BRS-02 Brush and Instruction manual	S016842
<b>POWER SUPPLY</b>	
ADC-09A AC Adapter (RS01/RS02/RS03)	S016820
ACC-09 Power cord	S014390
BTR-12 Battery (RS03)	S016832
<b>Miscellaneous</b>	
SPA-RS02-08 SPACER	S016818

## Thermal Strippers

### Specifications

MODEL	RS01	RS02	RS03	RS03-80
Applicable optical fiber	Glass optical fibers, capillary			
Fiber count	1 to 16			Single
Cladding diameter	125 µm			80 µm
Coating diameter	200 to 400 µm			150 to 250 µm
Stripping length	Up to 35 mm			
Typical heating time	3 sec. 5 sec. at Eco mode			
Heating temperature	85° - 140°C			
Fiber holder	All FH-40, FH-50, FH-60, FH-70, and FH-100 series fiber holders (except FH-50-250 and FH-50-900)			
Wireless connectivity	N/A	Bluetooth®4.1 LE*1 OS:Android 5.0 or above , iOS 8.0 or above (iPhone6 or above)		
Dimensions	155.5 (W) × 48.7 (D) × 32.5 (H) mm		155.5 (W) × 48.7 (D) × 36.8 (H) mm	
Weight	185 g		265 g (with Battery)	
Power supply	AC Adaptor Input: 100 to 240V, 50/60 Hz, Max – 0.58 A Output: Approx. DC 12 V, Max 2A DC External Supply: DC10 to 17V, Max – 1A		AC Adaptor Input: 100 to 240V, 50/60 Hz, Max – 0.58 A Output: Approx. DC 12 V, Max 2 A DC External Supply: DC10 to 17 V, Max – 1 A BTR-12 Battery: DC7.2 V, 1840 mAh (Rechargeable Lithium Ion)	
Battery capacity	N/A		Approx. 600 strips with Eco mode	
Recharge Time			Approx. 2 hr from empty	
Battery Life			Approx. 500 recharge cycles	
Operating conditions	Temperature: -10 to 50°C, Humidity: 0 to 95% RH (Non-condensing)			
Storage conditions	Temperature: -20 to 60°C, Humidity: 0 to 95% RH (Non-condensing)			

## Splice Protection Sleeves

AFL offers a wide selection of fiber protection sleeves to meet any application. The FP series is the industry standard for durable and lasting protection of single fiber splices in field installations, while the FP-04(T) and FP-05 provide the same durable protection for 8 and 12 fiber ribbon respectively.

The FPS01 and FPS04 series are specially designed for optical components, where small packaging is a priority. These micro sleeves provide the known reliability of Fujikura sleeves in the smallest possible lengths. This easy and cost effective method is a great alternative to recoating. The FPS01 and FPS04 series offer a wide range of options to accommodate various coating sizes, and are manufactured in a variety of lengths. This gives great flexibility in designing optical modules.

### Standard Sleeves: Dimensions & Applicable Fiber

#### SLEEVES FOR SINGLE FIBERS 250 MICRONS TO 900 MICRONS

DESCRIPTION	SLEEVE LENGTH	FIBER CLEAVE LENGTH	SLEEVE DIAMETER AFTER SHRINK	MOQ & MOM	AFL NO.
FP-40 Slim Protection Sleeve	40 mm	10 mm	2.3 mm (max.)	1,000 & 100	S018262
FP-60 Slim Protection Sleeve	60 mm	10 mm	2.3 mm (max.)	1,000 & 100	S018263
FP-60	60 mm	10 mm	3.1 mm (max.)	1,000 & 100	S015915
FP-40	40 mm	10 mm	3.1 mm (max.)	1,000 & 100	S015916

#### SLEEVES FOR UP TO 250 MICRON COATED RIBBON

DESCRIPTION	FIBER COUNT	SLEEVE LENGTH	FIBER CLEAVE LENGTH	SLEEVE DIAMETER AFTER SHRINK	MOQ & MOM	AFL NO.
FP-04(T)	Up to 8 fibers	40 mm	10 mm	4.0 mm (max.)	250 & 250	S002105
FP-05	Up to 12 fibers	40 mm	10 mm	4.5 X 4.0 mm (max.)	250 & 250	S003027
FP-05-28	Up to 12 fibers	28 mm	10 mm	4.5 mm (max.)	5,000 & 250	S014720
FPS04-30	Up to 4 fibers	30 mm	10 mm	2.4 mm (max.)	250 & 250	S010848
FPS08-28	Up to 8 fibers	28 mm	10 mm	3.3 X 2.7 mm (max.)	500 & 500	S013560
FPS24-40	Up to 24 fibers	40 mm	10 mm	8.0 X 4.0 mm (max.)	200 & 200	S013004

### Specifications

PARAMETER	DESCRIPTION	VALUE
Outer tube	FP-60/40/03 series	Polyolefin based on Polyethylene
	FPS-04(T) / FP-05	Ethylene-Vinyl Acetate
Inner Tube	ALL	Ethylene-Vinyl Acetate
Strength member	FP-60/40/03 series	Stainless steel
	FP-04(T) / FP-05	Heat-resistant glass
Operation condition (after shrink)		-10 to 50°C, 0 to 95% RH (Non dew)
Storage condition (before shrink)		-40 to 60°C, Non dew

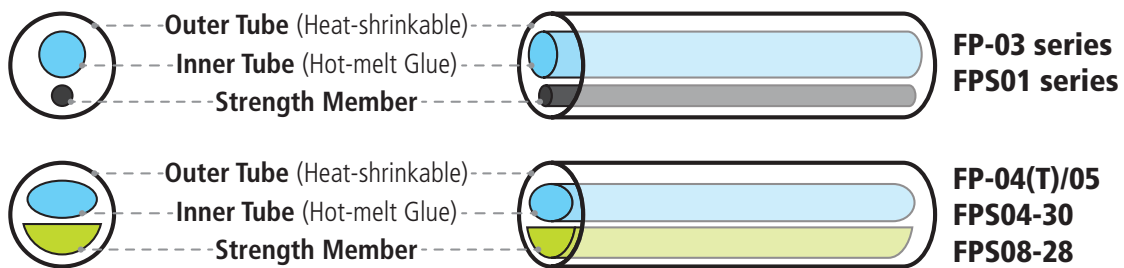

## Splice Protection Sleeves

### Micro Sleeves: Dimensions & Applicable Fiber

#### FPS01-400 SERIES FOR SINGLE FIBERS UP TO 400 MICRON FIBER

DESCRIPTION	SLEEVE LENGTH	FIBER CLEAVE LENGTH	SLEEVE DIAMETER AFTER SHRINK	PACKAGING	AFL NO.
FPS01-400-12	12 mm	4 mm	1.5 mm	50 Pack	S014088
FPS01-400-15	15 mm	5 mm	1.5 mm	50 Pack	S012668
FPS01-400-20	20 mm	8 mm	1.5 mm	50 Pack	S012672
FPS01-400-25	25 mm	10 mm	1.5 mm	50 Pack	S012676
FPS01-400-34	34 mm	15 mm	1.5 mm	50 Pack	S012680
FPS01-400-40	40 mm	16 mm	1.5 mm	1,250 Box	S011914

#### FPS01-900 SERIES FOR SINGLE FIBERS UP TO 900 MICRON FIBER

DESCRIPTION	SLEEVE LENGTH	FIBER CLEAVE LENGTH	SLEEVE DIAMETER AFTER SHRINK	PACKAGING	AFL NO.
FPS01-900-15	15 mm	4 mm	2.3 mm	50 Pack	S012684
FPS01-900-20	20 mm	6 mm	2.3 mm	50 Pack	S012688
FPS01-900-25	25 mm	6 mm	2.3 mm	50 Pack	S011954
FPS01-900-34	34 mm	13 mm	2.3 mm	50 Pack	S012692
FPS01-900-45	45 mm	16 mm	2.3 mm	50 Pack	S012696

### Specifications

PARAMETER	DESCRIPTION	VALUE
Outer tube	FPS01 series / FPS04-30 / FPS08-28 / FPS24-40	Polyolefin based on Polyethylene
Inner Tube	ALL	Ethylene-Vinyl Acetate
Strength member	FPS01 series	Stainless steel
	FPS04-30 / FPS08-28 / FPS24-40	Heat-resistant glass
Operation condition (after shrink)		-10 to 50°C, 0 to 95% RH (Non dew)
Storage condition (before shrink)		-40 to 60°C, Non dew

### Type Variations



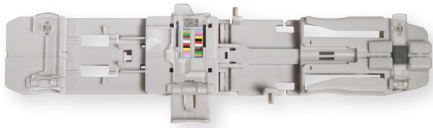

RT-02

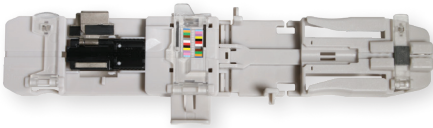

RT-02 with FH-70-12PC

## RT-02 Ribbonizing Tool

The RT-02 is the latest ribbonizing tool from Fujikura, and the first universal ribbonizing tool on the market suitable for forming a temporary ribbon from loose 200 μm or 250 μm fibers. This is also the first tool that features a glue-less process for ribbonizing and splicing 12 fiber ribbons. This saves time and money by eliminating operating inefficiencies such as cure time and contamination of splicing equipment. Simply choose the applicable fiber holder in conjunction with the RT-02 to ribbonize 200 μm or 250 μm fibers. With this tool, you can now realize the benefits of mass fusion splicing when installing the latest generation of loose fiber micro cables.

### Features

- No glue required
- 200 μm and 250 μm compatible
- Loading with color code sequence not required
- Fibers load directly into fiber holder
- Left and right fiber holder color codes printed on tool

### Applications

- Ribbonizing 200 μm and 250 μm loose fibers
- 200 μm and 250 μm MPO termination
- Mass fusion splicing loose fiber cables

### Ordering Information

DESCRIPTION	AFL NO.
RT-02 (tool only)	S017465
FH-70-12PC (pair of pitch conversion holders for 200 μm loose fibers)	S017464
FH-70-12 (pair – standard 12F ribbon holders)	S017119



## FST-12 Fiber Separation Tool

The FST-12 Fiber Separation Tool is used to quickly, accurately and reliably split ribbons into sub-groups or individual fibers. The ergonomic FST-12 design enables safe and reliable, one-handed operation for use in diverse fiber deployment environments, such as aerial and remote-site applications.

### Features and Benefits

- Enables separation of groups of fibers or single fibers and is not limited to only even-numbered groupings.
- One-handed operation allows the operator’s other hand to guide and control the ribbon at all times, minimizing the potential for accidental damage to the fibers or ribbon.
- Hand-held method eliminates the need to utilize valuable work surface space for operation and is the ideal solution for remote-site and aerial operations such as bucket truck or ladder-sling applications.
- Performing two overlapping separations of the ribbon allows any single fiber or any sub-group of fibers to be extracted from the ribbon, even in mid-span taut-sheath operations where minimal ribbon length is available.
- Standard tool designed for fiber counts up to 12-fiber ribbon.

### Specifications

PARAMETER	VALUE
Ribbon Thickness	250 to 360 micron
Ribbon Width	3.2 mm (12-fiber)
Fiber Pitch	250 micron
Fiber Coating Material	UV cured resin
Separation Ratios: 12-fiber Ribbon	1:11, 2:10, 3:9, 4:8, 5:7, 6:6
Environmental Conditions: Operating Temperature	-10° to 50°C, 0 to 95% RH (non-dew)
Storage Temperature	-40° to +80°C, 0 to 95% RH (non-dew)
Dimensions	160L x 126W x 30H (mm) 6.30L x 4.96 x 1.18 (in)
Weight	220 g / 7.76 oz.

### Ordering Information

DESCRIPTION	AFL NO.
<b>FST-12 Fiber Separation Tool</b> Includes: 12-fiber ribbon jaw set, instructional manual and color coded quick reference guide	S014012



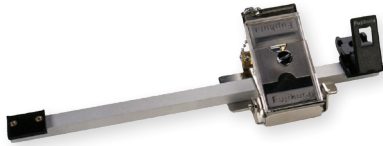

FAT-04

## Fiber Arrangement Tool

The FAT-04 features an easy-to-use fiber arrangement method utilizing linear travel. The FAT-04 includes a spare paste applicator to allow ribbon making to continue even if one of the paste applicators needs cleaning.

### Ordering Information

DESCRIPTION	AFL NO.
FAT-04 Fiber Arrangement Tool*	S010212
SP-1 Foam Pads for FAT-04 (One set = 5 sheets of 25 pads each)	S009016
Paste Applicator Blocks for FAT-04 (2 pieces)	S010952

\* FAT-04 includes 4 oz. FAA-03A ribbon forming adhesive, paste applicator blocks, cleaning swabs, CL-02 clips and SP-1 foam pads



FAA-03A

## Ribbon Forming Adhesive

A key advantage of our fiber arrangement tool is the use of the ribbon forming adhesive. Ribbons formed with this adhesive have excellent stripability, especially compared to ribbonizing methods using tape. Unlike tape methods, the paste does not “gum-up” the stripping tool and cause broken fibers. The paste holds the stripped coating residue into a single piece of debris that is easily cleaned from the stripper. If needed, the ribbon can be easily separated into individual fibers using alcohol.

### Ordering Information

DESCRIPTION	AFL NO.
FAA-03A ribbon-forming adhesive (0.5 liter bottle)	S008622
FAA-03A ribbon-forming adhesive (4 oz. dispensing bottle)	S008720



Splicer V-groove Cleaning Refill Kit

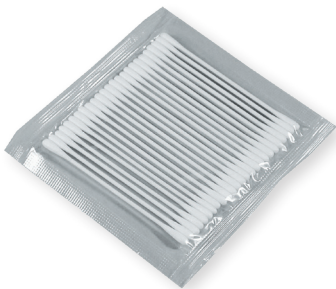

CS-1 Cotton Swabs

## Splicer V-groove Cleaning Kit

Today's splicing equipment is fast, efficient, and requires minimal maintenance due to advances in splicing technology. However, contamination in the V-groove of the splicer is still a primary source of trouble for the splicing technician. This is especially problematic when splicing with a fixed V-groove fusion splicer. Environmental contamination, such as dust, dirt and fiber coating debris, as well as the silica deposits generated during the fusion process eventually find their way to the surface of the v-groove. This contamination will offset the fibers and degrade performance. To help control this problem, a disciplined cleaning regimen and specific tooling is required to ensure the splice is right the first time.

To solve cleaning needs, AFL offers the Splicer V-groove Cleaning Kit. This product integrates eight components into an affordable and effective inspection and cleaning solution for any fusion splicer. Small and lightweight, it fits easily into the Fujikura splicer transit case or it can be carried separately in its own carrying case.

### Kit Includes

- Scrubber Brush with stiff tapered nylon bristles
- Sweeper Brush with soft nylon bristles
- Eye Loupe with 3X to 12X magnification
- LED Pen Light with momentary or constant on switching
- Cleaning Fluid that is nonflammable and environmentally safe
- Lint-free Cotton Swabs
- Instruction Sheet with illustrations
- Canvas Carrying Case

### Refill Kit Includes

To replenish the consumables within the kit, AFL provides a refill kit that includes the following components:

- One can of FCC2 Cleaning Fluid
- One Scrubber Brush
- One Sweeper Brush
- Ten packs CS-1 Cotton Swabs (250 swabs)

### Ordering Information

DESCRIPTION	AFL NO.
Splicer V-groove Cleaning Kit	S014397
Splicer V-groove Cleaning Refill Kit	S014416
CS-1 Cotton Swabs (pack of 25 swabs)	S003719



Portable Tripod Workstation Kit (splicer and cleaver not included)

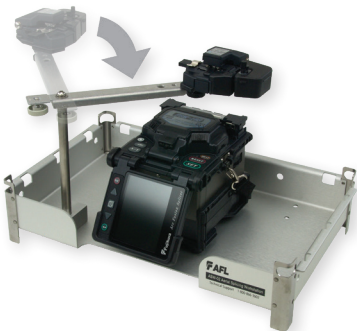

Cleaver mount assembly swings into and out of the work space

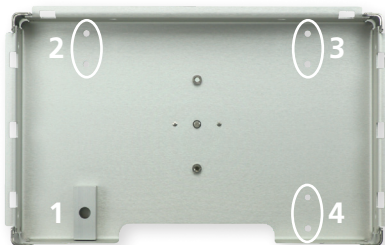

Portable Work Tray showing the four mounting positions of the cleaver mount assembly (delivered as shown)

## Portable Tripod Workstation

As splicing requirements have migrated from aerial to ground level locations, a sturdy splicing workstation with the ability to adjust for uneven ground surfaces has been missing from the splicing marketplace. That problem is solved with AFL’s Portable Tripod Workstation – the critical missing link in splicing productivity.

The Portable Tripod Workstation offers both a sturdy work tray to support the splicer, cleaver and accessories, and a tripod to support the work tray. The two can be purchased together as a kit or separately for those users who prefer to use their own tripod or mounting mechanism.

The work tray incorporates a unique cleaver mounting system that offers flexibility and convenience for the user. The cleaver mounting arm pivots into and out of the work space, as needed, and securely captures the CT50, CT-20 and CT-04 style cleavers. The base of the cleaver mounting assembly can be moved to any one of four positions on the tray to accommodate user preferences.

The tripod is solidly constructed but lightweight, weighing less than six pounds, and collapses to a length of only twenty-five inches. The telescoping legs offer flexible height adjustments from thirteen inches to sixty-one inches and the leg angle can be increased for unusual surfaces.

### Features

- Sturdy work tray supports the splicer, cleaver and accessories
- Tripod supports a load capacity of up to eleven pounds
- Independent telescoping tripod legs support uneven work surfaces
- Leveraged handles securely lock work tray into position
- Cleaver mount assembly swings cleaver into and out of the work space
- Optional cleaver mounting positions accommodate user preferences
- Compatible with all FSM-17, FSM-18, FSM-50, FSM-60 and 12/19/70 series models

### Ordering Information

DESCRIPTION	AFL NO.
<b>Portable Tripod Workstation Kit – Includes:</b> Tripod with pan head and quick release platform (make and model of tripod may change without notice), portable work tray with cleaver mount assembly and canvas carrying case	S014773
<b>Portable Work Tray – Includes:</b> Portable work tray with cleaver mount assembly and canvas carrying case	S014753
<b>Tripod – Includes:</b> Tripod with pan head and quick release platform (make and model of tripod may change without notice)	S014751

### Optional Accessories

DESCRIPTION	AFL NO.
<b>TS-01 TRIPOD SCREW</b> (required for 12S & 12R models)	S015895



Splicing Workstation



Aerial mounting system

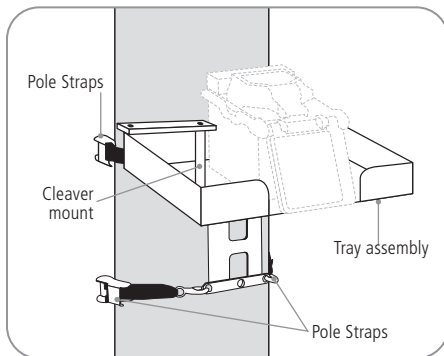

**Pole Mounting System**

*\*Illustration for reference only.*

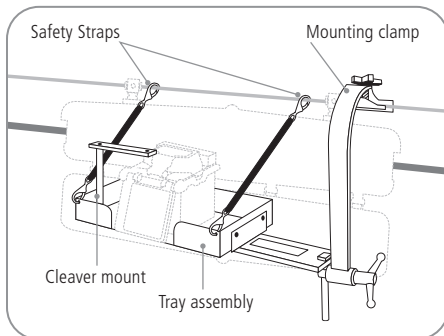

**Aerial Mounting System**

*\*Illustration for reference only.*

## ASW-02 Splicing Workstation

The ASW-02 Splicing Workstation can be used with a fusion splicer and cleaver in aerial or terrestrial splicing applications. The ASW-02 provides a stable work surface and secure mounting of the splicer and cleaver to prevent accidental drops and equipment damage in challenging splicing locations.

The ASW-02 Splicing Workstation consists of the work tray, a convenient pivoting cleaver mounting arm, a post for attachment to bucket or ladder mounting accessories, a tripod mount, and dual safety straps. An aerial mounting system is available for direct attachment of the workstation to a telephone pole, or for suspending the workstation from an aerial cable strand. The strand mounting system is fully adjustable to provide for optimal location of the workstation when minimal slack fiber is available, such as in a taut-sheath cable access scenario.

In the aerial environment, the safety straps may be secured to the cable strand to provide security and aid with workstation position adjustment. The safety straps are also used to secure the workstation to the pole, and may be used to raise or lower the workstation.

### Features

- Provides direct to pole mounting as well as direct adjustable attachment to aerial strand
- Mounting post provided for attachment to bucket and ladder mounting accessories (utilizing any popular copper splicer-head mounting rigs)
- Tripod mount allows for placement in tight FTTH splicing applications
- Includes cable tie locations to secure cables during splicing
- Optimized to simplify taut sheath splicing applications
- Cleaver mount securely captures cleaver and allows operator to rotate it in and out of the workspace as needed
- Matte finish minimizes glare
- Compatible with all FSM-17, FSM-18, FSM-50, FSM-60 and 19/70 series models

### Ordering Information

DESCRIPTION	AFL NO.
<b>ASW-02 Splicing Workstation (Full kit with aerial mounting system)</b> Includes aerial mounting system to provide strand and pole mounting capability, a post for attachment to bucket or ladder mount accessories and a receptacle for tripod mounting and safety straps	S010532
<b>ASW-02 Splicing Workstation (Without aerial mounting system)</b> Includes a post for attachment to bucket or ladder mount accessories and a receptacle for tripod mounting	S013620

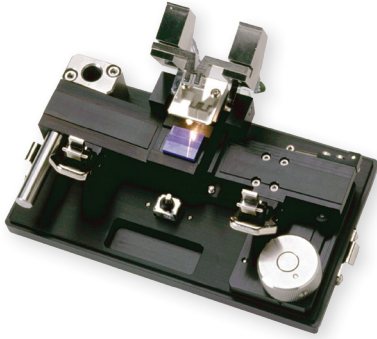

## TJ-03 Temporary Joining Tool

The TJ-03 is a temporary mechanical fiber splice for fiber and cable connections to test equipment such as OTDRs or fiber optic cable reels. The TJ-03 uses a precision ceramic V-groove to align up to 12 fibers simultaneously. The fibers are prepared for joining by using standard mass fusion fiber preparation tools (fiber holders, thermal stripper, and cleaver.) Using the TJ-03 in conjunction with an OTDR equipped with an optical switch provides rapid one button optical tests of 12 fibers.

### Features

- Precision ceramic V-groove alignment
- Built-in magnifier and lamp to inspect fiber placement in V-grooves

### Ordering Information

DESCRIPTION	AFL NO.
TJ-03 Temporary Splice Kit Includes: Fiber Holders (1 pair) FH-50-12N, CT50 Cleaver, RS02 Thermal Stripper, ADC-09A AC Adapter for RS02 and the ACC-09 Power Cord	S012772
TJ-03 Temporary Splice (without fiber preparation tools)	S010456





# LAZERMasteR®

## LZM-125A+ Splicing System

The LAZERMasteR LZM-125A+ is a splicing and glass processing system that uses a CO<sub>2</sub> laser heat source to perform splicing, tapering (to create MFAs), lensing, or other glass shaping operations with glass diameters of 2.0 mm or less. The high-resolution optical analysis system works in conjunction with on-board firmware for fully automatic splicing, tapering and other glass shaping processes.

High precision glass processing is enabled by the intuitive and user-friendly on-board firmware (virtually identical to that of the Fujikura FSM-100 splicers). Operations may also be performed manually and by PC control. The FPS PC control GUI is supplied with the LZM-125A+ to provide additional features, greater flexibility, and finer control. The FPS GUI may be used on a PC chosen by the customer. Customers can also create proprietary PC control algorithms using a complete set of PC control commands.

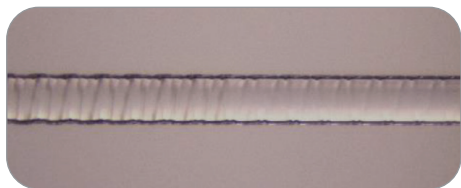

Ablated Fiber Surface

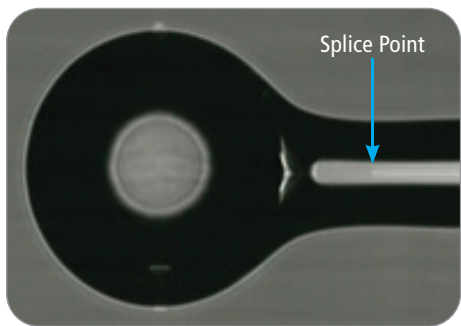

Coreless Ball Lens to Collimate SMF Fiber

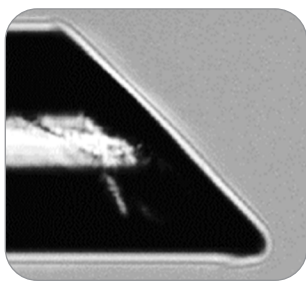

Ablated Fiber Surface

### Features

- Fiber Ablation that can be used for cleaving, shaping, or custom mode stripping
- Splices and glass processing of fibers with 80 μm up to 2.0 mm diameter
- High resolution motion for precise control during splicing and glass processing operations
- Extensive library of applications which are transferable between the LZM and FSM family
- FPS PC GUI provides additional measurement capabilities and glass shaping control
- Clean modular laser heat source: Absolutely no deposits on fiber surface as might occur with filaments or electrodes.
- Substantially reduces maintenance and calibration requirements
- Proprietary feedback system ensures heating power stability
- No need for external process gas (as required with filament systems) or Vacuum systems
- Class 1 System with redundant automated laser safety features
- Motorized mirrors to automatically adjust the beam path

### Ordering Information

DESCRIPTION	AFL NO.
<b>LAZERMasteR LZM-125A+ Glass Processing and Splicing System</b> (Standard baseline LZM-125 system. Includes AC adapters and cords and FPS PC software.)	S017800
Optional Tablet PC (includes FPS software pre-installed) (recommended)	S016772
LZM Training (Optional US based at customer locations)	S015867
LZM Training (Optional International)	S015868
Splicer V-groove Cleaning Kit	S014397

*continued*  
→

# LAZERMaster<sup>®</sup>

## LZM-125A+ Splicing System

### Specifications

PARAMETER	CO <sub>2</sub> LASER
Fiber Heating and Splicing Method	30 W standard
CO <sub>2</sub> Laser Power	Metal cover with multiple interlocks, class 1 enclosure, automatic actuation of shutter, automatic laser power cutoff
Laser Safety Features	Proprietary feedback system assures laser beam power stability
Laser Beam Control	Standard beam size is 4.5 mm X 2 mm and a minimum spot of 30 μm for ablations)
Typical Splice Loss	0.02 dB for SMF (ITU-T G.652)
Typical Splice Strength	100 kpsi for SMF (ITU-T G.652) using appropriate fiber preparation equipment
Camera Field of View	2.3 mm
Fiber Observation Methods	PAS (Profile Alignment System) via transverse fiber observation WSI (Warm Splice Image) and WTI (Warm Taper Image) End-view observation
Applicable Fiber Diameter	End-view observation
V-Groove Clamping System	80 μm to 2000 μm for automatic alignment by PAS Larger diameter endcaps may be aligned manually
Fiber Handling	Infinitely variable from 80 μm up to 2000 μm Clamping bare fiber or fiber coating in the "split V-groove" system
Alignment Methods	<ul style="list-style-type: none"> <li>• PAS (Profile Alignment System, automatic alignment by camera observation)</li> <li>• Manual</li> <li>• PC control with Power Meter feedback via GPIB/USB</li> <li>• End-view</li> </ul>
Endless Theta Rotation	360° endless rotation, angle resolution 0.1°
X/Y Alignment Resolution	Sub-micron
Maximum Z Travel Length	18 mm (both left and right Z units) as well as sweep with a total of 36 mm
Z Travel Resolution	0.125 μm theoretical
Maximum Taper Length	32 mm
Maximum Taper Ratio	10:1 standard (For uniform direction, one-pass tapering) Dual direction tapering offers greatly increased taper ratios, as does tapering with more than one tapering pass.
Maximum Taper Speed	1 mm/sec standard
Splicing Control	Internal firmware or operation by PC
Fiber Tapering and Glass Shaping Control	Internal firmware or operation by PC
PC Control	FPS software will be provided Complete command set for PC control
PC Option	Optional Tablet PC (includes FPS software pre-installed). Use of the FPS software on a PC provides finer control and additional features compared to the LZM-110 internal firmware
Interface Ports	USB 2.0 (For PC communications, data and image download, etc.) GPIB/USB (for power meter feedback)
Electrical Power	100-240 VAC
Operating Conditions / Storage Conditions	10 to 40°C / 5 to 60°C
Rotation Motors	For LZM-125A+, theta rotational motion is available for PM fiber alignment.
PM Fiber Alignment Methods	<ul style="list-style-type: none"> <li>• PAS (For PANDA and other PM fibers)</li> <li>• IPA (Interrelation Profile Alignment, applicable to almost all PM fibers. Three distinct IPA methods available.)</li> <li>• End-view</li> <li>• Power meter feedback (Requires polarizer and analyzer, as well as GPIB interface)</li> <li>• Manual</li> <li>• Other methods by PC control</li> </ul>
End-View Observation and Alignment	Internal end-view system
Flexibility for Customer Design Input	Customizable platform





# LAZERMaster®

## LZM-125M/LZM-125P Splicing System

The LAZERMaster LZM-125M/LZM-125P is a splicing and glass processing system that uses a CO<sub>2</sub> laser heat source to perform splicing, tapering (to create MFAs), lensing, or other glass shaping operations with glass diameters of 2.0 mm or less. The high-resolution optical analysis system works in conjunction with on-board firmware for fully automatic splicing, tapering and other glass shaping processes.

High precision glass processing is enabled by the intuitive and user-friendly on-board firmware (virtually identical to that of the Fujikura FSM-100 splicers). Operations may also be performed manually and by PC control. The FPS PC control GUI is supplied with the LZM-125M/LZM-125P to provide additional features, greater flexibility, and finer control. The FSP GUI may be used on a PC chosen by the customer. Customers can also create proprietary PC control algorithms using a complete set of PC control commands.

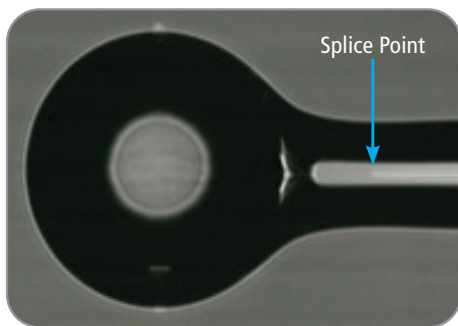

Coreless Ball Lens to Collimate SMF Fiber



Tapered Probe with Small Ball End

### Features

- Splices and glass processing of fibers with 80 μm up to 2.0 mm diameter
- High resolution motion for precise control during splicing and glass processing operations
- Extensive library of applications which are transferable between the LZM and FSM family
- FPS PC GUI provides additional measurement capabilities and glass shaping control
- Clean modular laser heat source: Absolutely no deposits on fiber surface as might occur with filaments or electrodes.
- Substantially reduces maintenance and calibration requirements
- Proprietary feedback system ensures heating power stability
- No need for external process gas (as required with filament systems) or Vacuum systems
- Class 1 System with redundant automated laser safety features
- Motorized mirrors to automatically adjust the beam path

### Ordering Information

DESCRIPTION	AFL NO.
<b>LAZERMaster LZM-125M Glass Processing and Splicing System</b> (Standard baseline LZM-125 system. Includes AC adapters, cords and FPS PC software)	S017801
<b>LAZERMaster LZM-125P Glass Processing and Splicing System</b> (Standard baseline LZM-125 system. Includes AC adapters, cords and FPS PC software)	S017803
Optional Tablet PC (includes FPS software pre-installed) (recommended)	S016772

*continued*  
→

# LAZERMaster<sup>®</sup>

## LZM-125M/LZM-125P Splicing System

### Specifications

PARAMETER	VALUE
Fiber Heating and Splicing Method	CO <sub>2</sub> Laser
CO <sub>2</sub> Laser Power	30 W standard
Laser Safety Features	Metal cover with multiple interlocks, class 1 enclosure, automatic actuation of safety shutter, automatic laser power cutoff
Laser Beam Control	Proprietary feedback system assures laser beam power stability
Typical Splice Loss	0.02 dB for SMF (ITU-T G.652)
Typical Splice Strength	100 kpsi for SMF (ITU-T G.652) using appropriate fiber preparation equipment
Camera Field of View	2.3 mm
Fiber Observation Methods	PAS (Profile Alignment System) via transverse fiber observation WSI (Warm Splice Image) and WTI (Warm Taper Image)
Applicable Fiber Diameter	80 μm to 2000 μm for automatic alignment by PAS Larger diameter endcaps may be aligned manually
V-groove Clamping System	Infinitely variable from 80 μm up to 2000 μm Clamping bare fiber or fiber coating Patented “split V-groove” system
Fiber Handling	Fujikura FSM-100, FSM-45, and FSM-40 splicer fiber holders
Alignment Methods	3 methods for PM alignment: <ul style="list-style-type: none"> <li>• PAS (Profile Alignment System, automatic alignment by camera observation) Manual</li> <li>• Other methods by PC control</li> <li>• Power meter feedback via GPIB</li> </ul>
Endless Theta Rotation	360° endless rotation for 125P model, angle resolution 0.1°
X/Y Alignment Resolution	0.1 μm
Maximum Z Travel Length	5 mm (both left and right Z units) as well as sweep with a total of 10 mm
Z Travel Resolution	0.125 μm theoretical
Maximum Taper Length	8 mm
Maximum Taper Ratio	10:1 standard (For uniform direction, one-pass tapering) Dual direction tapering offers greatly increased taper ratios, as does tapering with more than one tapering pass.
Maximum Taper Speed	1 mm/sec standard
Splicing Control	Internal firmware or operation by PC
Fiber Tapering and Glass Shaping Control	Internal firmware or operation by PC
PC Control	FPS software will be provided complete command set for PC control
PC Option	Tablet computer is available as an option. Use of the FPS software on a PC provides finer control and additional features compared to the LZM-125 internal firmware.
Interface Ports	USB 2.0 (For PC communications, data and image download, etc.) GPIB (for power meter feedback)
Electrical Power	100-240 VAC
Operating/Storage Conditions	10 to 40°C / 5 to 60°C
Rotation Motors	Optional (Provides theta rotational motion for PM fiber alignment in the LZM-125P model)
PM Fiber Alignment Methods	<ul style="list-style-type: none"> <li>• PAS (For PANDA and other PM fibers)</li> <li>• IPA (Interrelation Profile Alignment, applicable to almost all PM fibers. Three distinct IPA methods available.)</li> <li>• Power meter feedback (Requires polarizer and analyzer, as well as GPIB interface)</li> <li>• Manual</li> <li>• Other methods by PC control</li> </ul>
Flexibility for Customer Design Input	Customizable platform



# LAZERMaster<sup>®</sup>

## LZM-125M+/LZM-125P+ Splicing System

The LAZERMaster LZM-125M+/LZM-125P+ is a splicing and glass processing system that uses a CO<sub>2</sub> laser heat source to perform splicing, tapering (to create MFAs), lensing, or other glass shaping operations with glass diameters of 2.0 mm or less. The high-resolution optical analysis system works in conjunction with on-board firmware for fully automatic splicing, tapering and other glass shaping processes.

High precision glass processing is enabled by the intuitive and user-friendly on-board firmware (virtually identical to that of the Fujikura FSM-100 splicers). Operations may also be performed manually and by PC control. The FPS PC control GUI is supplied with the LZM-125M+/LZM-125P+ to provide additional features, greater flexibility, and finer control. The FSP GUI may be used on a PC chosen by the customer. Customers can also create proprietary PC control algorithms using a complete set of PC control commands.

### Features

- Splices and glass processing of fibers with 80 μm up to 2.0 mm diameter
- High resolution motion for precise control during splicing and glass processing operations
- Extensive library of applications which are transferable between the LZM and FSM family
- FPS PC GUI provides additional measurement capabilities and glass shaping control
- Clean modular laser heat source: Absolutely no deposits on fiber surface as might occur with filaments or electrodes.
- Substantially reduces maintenance and calibration requirements
- Proprietary feedback system ensures heating power stability
- No need for external process gas (as required with filament systems) or Vacuum systems
- Class 1 System with redundant automated laser safety features
- Motorized mirrors to automatically adjust the beam path

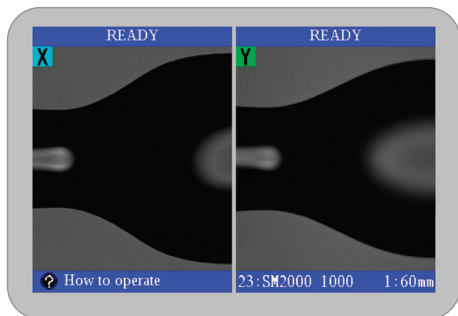

Coreless Ball Lens to Collimate SMF Fiber

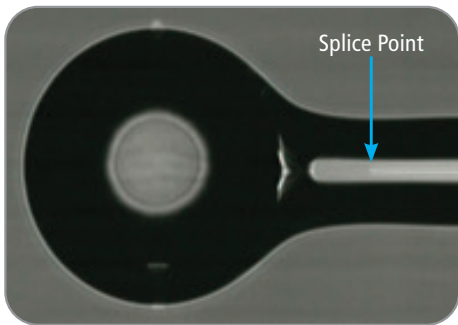

Coreless Ball Lens to Collimate SMF Fiber



Tapered Probe with Small Ball End

### Ordering Information

DESCRIPTION	AFL NO.
<b>LAZERMaster LZM-125M+ Glass Processing and Splicing System</b> (Standard baseline LZM-125 system. Includes AC adapters, cords and FPS PC software)	S017802
<b>LAZERMaster LZM-125P+ Glass Processing and Splicing System</b> (Standard baseline LZM-125 system. Includes AC adapters, cords and FPS PC software)	S017804
Optional Tablet PC (includes FPS software pre-installed) (recommended)	S016772

*continued*  
→

# LAZERMaster®

## LZM-125M+/LZM-125P+ Splicing System

### Specifications

PARAMETER	VALUE
Fiber Heating and Splicing Method	CO <sub>2</sub> Laser
CO <sub>2</sub> Laser Power	30 W standard
Laser Safety Features	Metal cover with multiple interlocks, class 1 enclosure, automatic actuation of shutter, automatic laser power cutoff
Laser Beam Control	Proprietary feedback system assures laser beam power stability
Typical Splice Loss	0.02 dB for SMF (ITU-T G.652)
Typical Splice Strength	100 kpsi for SMF (ITU-T G.652) using appropriate fiber preparation equipment
Camera Field of View	2.3 mm
Fiber Observation Methods	PAS (Profile Alignment System) via transverse fiber observation WSI (Warm Splice Image) and WTI (Warm Taper Image) End-view observation
Applicable Fiber Diameter	80 μm to 2000 μm for automatic alignment by PAS; Larger diameter endcaps may be aligned manually
V-groove Clamping System	Infinitely variable from 80 μm up to 2000 μm Clamping bare fiber or fiber coating Patented "split V-groove" system
Fiber Handling	Fujikura FSM-100, FSM-45, and FSM-40 splicer fiber holders
Alignment Methods	4 methods for PM alignment: <ul style="list-style-type: none"> <li>• PAS (Profile Alignment System, automatic alignment by camera observation) Manual</li> <li>• Other methods by PC control</li> <li>• Power meter feedback via GPIB</li> <li>• End-view</li> </ul>
Endless Theta Rotation	360° endless rotation for 125P+ model, angle resolution 0.1° (LZM-125P+ only)
X/Y Alignment Resolution	0.1 μm
Maximum Z Travel Length	18 mm (both left and right Z units) as well as sweep with a total of 36 mm
Z Travel Resolution	0.125 μm theoretical
Maximum Taper Length	32 mm
Maximum Taper Ratio	10:1 standard (For uniform direction, one-pass tapering) Dual direction tapering offers greatly increased taper ratios, as does tapering with more than one tapering pass
Maximum Taper Speed	1 mm/sec standard
Splicing Control	Internal firmware or operation by PC
Fiber Tapering and Glass Shaping Control	Internal firmware or operation by PC
PC Control	FPS software will be provided complete command set for PC control
PC Option	Tablet computer is available as an option. Use of the FPS software on a PC provides finer control and additional features compared to the LZM-125 internal firmware.
Interface Ports	USB 2.0 (For PC communications, data and image download, etc.) GPIB (for power meter feedback)
Electrical Power	100-240 VAC
Operating/Storage Conditions	10 to 40°C / 5 to 60°C
Rotation Motors	Optional (Provides theta rotational motion for PM fiber alignment) Available for both left and right fibers, or one side only (depending upon customer requirements)
PM Fiber Alignment Methods	<ul style="list-style-type: none"> <li>• PAS (For PANDA and other PM fibers)</li> <li>• IPA (Interrelation Profile Alignment, applicable to almost all PM fibers. Three distinct IPA methods available.)</li> <li>• End-view</li> <li>• Power meter feedback (Requires polarizer and analyzer, as well as GPIB interface)</li> <li>• Manual</li> <li>• Other methods by PC control</li> </ul>
End-View Observation and Alignment	Internal end-view system
Flexibility for Customer Design Input	Customizable platform



LZM -100

## LAZERMaster® LZM-100 Splicing System

The LZM-100 LAZERMaster is a glass processing and splicing system that uses a CO<sub>2</sub> laser heat source to perform splicing, adiabatic tapering (to create MFAs or pump combiners), lensing, or other glass shaping operations with glass diameters of 2.3 mm or more. The high resolution optical analysis system works in conjunction with on-board firmware for fully automatic splicing, tapering and other glass shaping processes.

High precision glass processing is enabled by the intuitive and user-friendly on-board firmware (virtually identical to that of the Fujikura FSM-100 ARCMaster splicers). Operations may also be performed manually and by PC control. An FPS PC control GUI is supplied with the LZM-100 to provide additional features, greater flexibility and finer control. The FPS GUI is pre-installed on the All-in-one computer. Customers can also create proprietary PC control algorithms using a complete set of PC control commands.

### Features

- CO<sub>2</sub> laser heat source eliminates electrode or filament maintenance, provides extremely stable operation and greatly reduces the need for periodic calibration
- Automated laser beam diameter control to fine tune the size of the heating area
- An advanced configurable system capable of producing tapers, ball lenses, combiners, MFAs, glass shaping and splicing
- Excellent performance for dissimilar diameter fiber splicing
- Ultra high strength splicing
- Redundant automated laser safety features
- 2.3 mm maximum fiber diameter (larger fibers may be spliced manually)
- Long travel / high resolution Z motion for long adiabatic tapers
- Automatic operation by on-board LZM-100 splicer firmware, manual operation or operation by PC (PC and FPS GUI included with the LZM-100 system)
- Intuitive FPS PC GUI: Easy to understand, navigate and operate
- Complete set of PC command codes enables users to develop proprietary processes

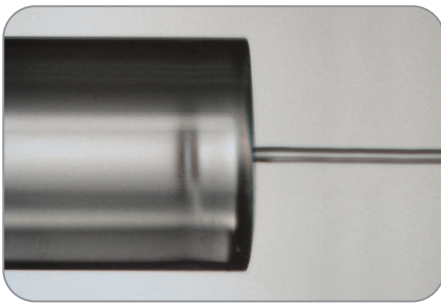

2 mm to 125 µm Splice

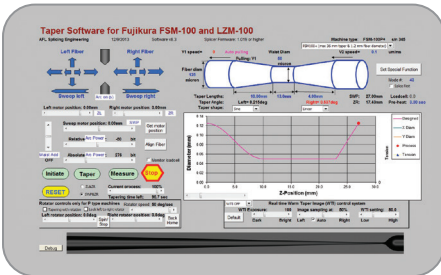

Advanced Adiabatic Tapering

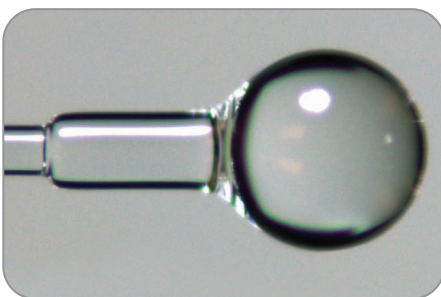

Ball Lens 320 µm with 125 Splice to 80 µm Fiber

### Ordering Information

DESCRIPTION	ITEM NO.
<b>LAZERMaster LZM-100 Glass Processing &amp; Splicing System</b> (Standard baseline LZM-100 system. Includes AC adapters & cords and SpliceLab PC software)	S015871
<b>LAZERMaster LZM-100</b> (with dual theta motors)	S015872
<b>All-in-one Computer</b> (includes keyboard and mouse, monitor stand for mounting all-in-one computer. SpliceLab software pre-installed.) (required)	S015242
<b>End-View Observation &amp; Alignment Option</b>	S015244
<b>Side Table Work Surface Option</b> (Work surface to provide additional area for accessories such as fiber preparation equipment. May be attached to the left or right side of the LZM-100 or both. Folds down against the side of the LZM-100 chassis when not needed or to allow easy movement through narrow doorways.)	S015247
<b>Cylindrical Lens &amp; Lens Holder</b> (optional)	S015251
<b>LZM-100 Training</b> (USA)	S015867
<b>LZM-100 Training</b> (International)	S015868
<b>Splicer V-Groove Cleaning Kit</b>	S014397



## LAZERMaster<sup>®</sup>

### LZM-100 Splicing System

#### Specifications

Fiber Heating and Splicing Method	CO <sub>2</sub> Laser
CO <sub>2</sub> Laser Power	30 W standard (Lasers expected lifetime is 20,000 hrs / 2.3 years before service is required.)
Laser Safety Features	<ul style="list-style-type: none"> <li>• Metal cover with interlock, class 1 enclosure</li> <li>• Automatic actuation of safety shutter</li> <li>• Automatic laser power cutoff</li> <li>• Triple redundancy</li> </ul>
Laser Beam Control	Proprietary feedback system assures laser beam power stability Laser beam size and shape may be customized to meet specific user requirements
Typical Splice Loss	0.02 dB for SMF (ITU-T G.652)
Typical Splice Strength	100 kpsi observed for SMF (ITU-T G.652) using appropriate fiber preparation equipment
Visible Field of View	2.5 mm (H) X 2.0 mm (W)
Fiber Observation Methods	<ul style="list-style-type: none"> <li>• PAS (Profile Alignment System) via transverse fiber observation.</li> <li>• WSI (Warm Splice Image) and WTI (Warm Taper Image)</li> <li>• End-view observation (Optional)</li> </ul>
Applicable Fiber Diameter	80 μm to 2300 μm for automatic alignment by PAS Larger diameter fibers may be aligned manually or by power meter feedback
V-Groove Clamping System	<ul style="list-style-type: none"> <li>• Infinitely variable from 80 μm up to 2300 μm</li> <li>• Clamping bare fiber or fiber coating</li> <li>• Patented “split V-groove” system</li> </ul>
Fiber Handling	Fujikura FSM-100, FSM-45 and FSM-40 splicer fiber holders Custom fixtures to meet specific customer requirements
Alignment Methods	<ul style="list-style-type: none"> <li>• PAS (Profile Alignment System, automatic alignment by camera observation)</li> <li>• Manual</li> <li>• Other methods by PC control</li> <li>• Power meter feedback via GPIB (Optional)</li> <li>• End-view (Optional)</li> </ul>
X/Y Alignment Resolution	Sub-micron
Maximum Z Travel Length	150 mm (both left and right Z units)
Z Travel Resolution	Sub-micron
Maximum Taper Length	130 mm
Maximum Taper Ratio	10:1 standard (For uniform direction, one-pass tapering) Dual direction tapering offers greatly increased taper ratios, as does tapering with more than one tapering pass.
Maximum Taper Speed	1 mm/sec standard (Optional 5 mm/sec)
Splicing Control	Internal firmware or operation by PC
Fiber Tapering & Glass Shaping Control	Internal firmware or operation by PC
PC Control	SpliceLab software will be provided Complete command set for PC control
PC Option	An all-in-one computer is required. Use of the SpliceLab software on a PC provides finer control and additional features compared to the LZM-100 internal firmware. Using another software application, the PC interface also allows for advanced maintenance functions such as the ability to confirm laser beam alignment, and align if required.
Interface Ports	USB 2.0 (For PC communications, data and image download, etc.) GPIB (Optional, for power meter feedback)
Electrical Power	100-240 VAC
Operating/Storage Conditions	+10° to +30°C / +5° to +40°C
Rotation Motors	Optional: Provides theta rotational motion for PM alignment for both left and right sides
PM Fiber Alignment Methods	<ul style="list-style-type: none"> <li>• PAS (For PANDA and other PM fibers)</li> <li>• IPA (Interrelation Profile Alignment, applicable to almost all PM fibers. Three distinct IPA methods available.)</li> <li>• End-view (Optional)</li> <li>• Power meter feedback (Requires polarizer and analyzer, as well as optional GPIB interface)</li> <li>• Manual</li> <li>• Other methods by PC control</li> </ul>
End-View Observation & Alignment	Optional internal end-view system

Preliminary Specifications, subject to revision and refinement



FSM-100M



FSM-100P

## Features

- Split V-groove clamping system
- "Plasma Zone" fiber positioning
- PAS and WSI
- New IPA alignment method for PM fibers
- Enhanced sweep arc technology
- Zero degree fiber handling for LDF
- Special functions for glass processing capability
- Fiber profile memory function
- New arc calibration technology
- Short cleave length capability
- Fast and accurate PANDA splice mode
- Ergonomic, production friendly design
- User selectable display on dual LCD monitors
- Internet firmware updates

# ARC Master™

## FSM-100M and FSM-100P Fusion Splicers

Whether splicing similar fiber types or double clad LDF fibers for high power lasers, the ARCMaster series splicers provide multiple solutions for diverse production needs. With State of the ARC™ technology, the ARCMaster sets the standard for fusion splicing with a multitude of new features designed to make splicing easier.

The patent-pending "split V-groove" fiber clamping system accommodates optical fiber ranges from 60 to 2,000 μm for cladding or coating without changing V-grooves or fiber clamps. The "Plasma Zone" fiber positioning system incorporates multiple fiber and electrode positioning techniques to provide unprecedented versatility for splicing LDF, heat sensitive or small diameter fibers.

With a new fiber imaging technology, Interrelation Profile Alignment (IPA), alignment and splicing capabilities are possible with virtually any PM fiber type. Longer fiber tapering application is possible with Fujikura's Sweep Arc technology. Incorporating PAS (cold fiber image) and WSI (warm image) technologies, the optical analysis system provides a number of advanced features including improved loss estimation capabilities, fiber image performance with both LDF, small or heat sensitive fibers.

Users can program multi-step glass processing operations to include non-splicing operations such as generating tapers or lenses. Dual LCD monitors provide enhanced data and graphical information that is user-selectable during each stage of the splicing process. Both units are designed with the needs for production in mind and are suitable for the most popular production workstations.

## Ordering Information

DESCRIPTION	AFL NO.
<b>ARC Master FSM-100M Fusion Splicer</b> (machine only) <b>Includes:</b> FH-100-250 fiber holders (pair), FH-100-900 fiber holders (pair), spare electrodes (pair), ADC-15 AC adapter, ACC-02 AC power cord, USB cable, dust cleaning swab set, operation manual and software on CD, transit case, and One year factory warranty	S014821
<b>ARC Master FSM-100M Fusion Splicer Kit *</b>	S014822
<b>ARC Master FSM-100P Fusion Splicer</b> (machine only) <b>Includes:</b> FH-100-250 fiber holders (pair), FH-100-400 fiber holders (pair), FH-100-900 fiber holders (pair), spare electrodes (pair), ADC-15 AC adapter, ACC-02 AC power cord, USB cable, dust cleaning swab set, operation manual and software on CD, transit case, and One year factory warranty	S014823
<b>ARC Master FSM-100P Fusion Splicer Kit *</b>	S014824
One year extended warranty (extends factory warranty by one year)	S012996
Two year extended warranty (extends factory warranty by two years)	S013000

\* Each splicer kit includes an RS01 Thermal Stripper, a CT52 Cleaver and a SPA-RS02-08 Spacer for RS01 in addition to the items listed above.





## ARCMaster™

### FSM-100M and FSM-100P Fusion Splicers

#### Specifications

PARAMETER	VALUE
Applicable Fiber	Silica based Single-mode and Multimode glass fiber: SMF (G.652), MMF (G.651), NZDSF (G.655), EDF, DCF, LDF and PMF, etc.
Fiber Dimension	Cladding diameter: 60 to 500 µm Coating diameter: 100 to 2,000 µm
Cleave Length	Glass clamping: 8 to 10 mm (standard 9 mm) Coating clamping: 3 to 5 mm (standard 4 mm)
Typical Splice Loss	SMF: 0.03 dB MMF: 0.02 dB NZDSF/LDF: 0.05 dB PMF: 0.06 dB (FSM-100P)
Splicing Time	SMF/MMF: 15 sec. NZDSF/LDF: 25 sec. PMF (PANDA): 35 to 50 sec. (FSM-100P) PMF (IPA): 90 to 300 sec. (FSM-100P)
Polarization Cross-Talk	PMF (PANDA): -40 dB / 0.6 degree (FSM-100P) PMF (IPA): -32 dB / 1.4 degree (FSM-100P)
Return Loss	60 dB or more
Heating Time	FP-40: 30 sec. FP-60: 35 sec. Micro sleeves: 55 sec.
Sweep Length	±5 mm
Electrode Life	2,500 Arc Discharges (SMF G.652 splicing at 1mm gap)
Electrode Gap	1 to 3 mm
Electrode Offset	-0.3 to +0.1 mm
Proof Test	1.96 N to 2.45 N
Dimensions (mm)	311W x 232D x 160H
Weight (excluding AC adapter)	FSM-100M: 7.5 kg FSM-100P: 8.0 kg
Operation Temperature	0°C to 40°C at 0 to 95% RH (Non-Dew)
Storage Temperature	-40°C to 80°C
Monitor Type	Dual 4.1 inch TFT color LCD monitors
Magnification	125 µm: 187 to 300 X 250 µm: 58 to 300 X 400 µm: 58 to 93 X

#### Accessories for the FSM-100M and FSM-100P

DESCRIPTION	AFL NO.
<b>High Strength Accessories</b>	
High Strength Preparation Kit Includes: USC-02, AFL PowerStrip and AFL PowerCleave	S013632
Ultrasonic Cleaner (USC-02)	S014783
HTS-12 High Tensile Stripper - includes 250 µm blades (400 µm available)	S012094
AFL PowerStrip High Tensile Stripper	S012808
AFL PowerCleave High Strength Cleaver	S009972
<b>Strippers</b>	
RS01 Thermal Stripper	S016815
RS03-80 Thermal Stripper	S016842
SPA-RS02-08 Spacer	S016818
<b>Electrodes</b>	
ELCT2-25 Spare Electrodes (pair)	S002068
<b>Cleavers</b>	
CT52 Cleaver	S017078
CT58 Cleaver ( for 80 µm cladding)	S017097
<b>Fiber Holders (Pairs)</b>	
FH-110-60 Fiber Holder	S018215
FH-110-100 Fiber Holder	S018216
FH-110-125 Fiber Holder	S018217
FH-110-150 Fiber Holder	S018218
FH-110-180 Fiber Holder	S018219
FH-110-210 Fiber Holder	S018220
FH-110-250 Fiber Holder	S018221
FH-110-300 Fiber Holder	S018222
FH-110-350 Fiber Holder	S018223
FH-110-400 Fiber Holder	S018224
FH-110-500 Fiber Holder	S018225
FH-110-600 Fiber Holder	S018226
FH-110-700 Fiber Holder	S018227
FH-110-800 Fiber Holder	S018228
FH-110-900 Fiber Holder	S018229
<b>Power and Cords</b>	
ADC-15 AC Adapter (FSM-100M/P)	S014826
ACC-02 AC Power Cord	S001171
ADC-09A AC Adapter (RS01)	S016820
ACC-09 AC Power Cord (for ADC-09)	S014390
<b>Miscellaneous</b>	
CC-27 Transit Case (100 M/P)	S014825
DCS-01 Dust Cleaning Swab	S014827
HP Power Meter Coupling Adapter	S012180
ILX Power Meter Coupling Adapter	S012184
Fiber Holder Adapter for HP/ILX PM	S012188
Splicer V-Groove Cleaning Kit	S014397



FSR-115



FSR-116



FSR-117

## FSR-115, FSR-116 and FSR-117 Optical Fiber Recoaters

AFL offers a complete lineup of high-quality optical fiber recoaters to reconstitute the primary coating of an optical fiber. In applications with flexible packaging requirements, high strength and high reliability splices, softer coatings for gyroscope splices, low-index coatings for power delivery and more.

The latest recoaters from Fujikura improve on their respective predecessors in numerous ways. The time to inject recoat material has been reduced by over 50% due to an improved pumping mechanism and new glass mold design. While still utilizing quartz glass, the new mold design improves both pump time and recoat length accuracy, especially for longer recoats, by improving the flow rate of material across the entire mold. The mold also features a unique RFID capability, enabling the FSR to automatically limit selectable recoat modes in the UI, based on mold size installed and recoat mode parameters. This feature speeds up application changeover and can serve as a production control measure. Further enabling ease of changeover, this FSR series includes user exchangeable inserts for different sizes and combinations of fiber coating and mold. To maintain concentricity of the fiber relative to the mold, the height of the fiber must change in the clamping system outside of the mold. This process is a simple exchange of metal inserts in the fiber clamps. For fine-tuned height adjustments, spare shims are included in every recoater shipment. Like their predecessors, the FSR-115 has no proof tension, the FSR-116 has a linear proof tester up to 2 kgf, and the FSR-117 has mandrel wraps for up to 10 kgf of tension or proof to failure for most fibers.

This generation of recoaters brings exciting benefits to the specialty fiber optic industry. Fujikura continues to lead with innovation and value in the quality solutions they develop. Put our recoaters to the test by contacting us at 1-800-235-3423.

### Features

- RFID mold identification for simple recoat mode selection
- Easy user exchangeable mold, inserts and shims for precise concentricity in any application
- Consistent, accurate recoat lengths
- Fast pumping mechanism for cycle time reduction
- Laser light illumination of recoat mold for ease of viewing during injection
- 2 kgf or 10 kgf proof tension depending on model
- Touchscreen graphical UI

*continued*  
→

## FSR-115, FSR-116 and FSR-117 Optical Fiber Recoaters

### Specifications

PARAMETER	FSR-115	FSR-116	FSR-117
Applicable optical fiber	Single Fiber		
Applicable fiber coating diameters	90-970 μm		
Recoat diameters	195 μm, 255 μm, 280 μm, 320 μm, 330 μm, 450 μm, 600 μm, 660 μm, 670 μm, 850 μm, 1000 μm Custom sizes available		
Recoat length	4 to 50 mm <sup>1</sup> Recoat Length Accuracy ±20% <sup>2</sup>		
Resin injection time	DSM 950-200: Injection 17 sec. <sup>2</sup> PC-373LD: 20 sec. <sup>2</sup>		
Resin curing time	DSM 950-200: 4 sec. <sup>2</sup> PC-373LD: 10 sec. <sup>2</sup>		
UV LEDs	UV LEDs are placed on top and bottom. Individual control of light emitting position, intensity and time are possible. UV Center Emission Wavelength Approx: 365 nm		
Mold material	Quartz		
Load application and mechanism	—	Linear Flat Clamp	Mandrel Wrap
Tension	—	0.2-2.0 kgf (1.96 N-19.61 N)	0.2-10.0 kgf (1.96 N-98.07 N)
Dimensions	252 mm (W) x 135 mm (D) x 169 mm (H)	252 mm (W) x 175 mm (D) x 169 mm (H)	
Weight	3.3 kg	4.8 kg	5.0 kg
Storage conditions	-40°C to 80°C, 0 to 95% RH non-condensing		
Operating conditions	10°C to 30°C, 0 to 95% RH non-condensing		
AC Adapter	Input power	AC 100 V to 240 V, 50/60 Hz Max, 1.5 A (ADC-21A)	
	Output power	DC 19 V, Max 2.1 A	
LCD monitor	TFT 4.95" touchscreen		
PC interface	USB 2.0 Type B mini		
Firmware update	Firmware downloaded from Fujikura servers via "Data Connection" PC Software		
Data storage	Recoating	100 programmable modes 5000 finished recoats	
	Proof testing	—	30 programmable modes 5000 finished proof test results
Wireless communication	RFID, ISO 15693 compliant		
Proof test calibration	—	Requires FGA-02 and FGP-20 force gauge <sup>3</sup>	

#### NOTES:

- Exact recoat length dependent on combination of recoat diameter, fiber coating, ambient temperature, and other environmental factors.
- Test Conditions
  - UV recoat resin: DSM 950-200 or Luvantix ADM Ltd. PC-373LD
  - Recoat diameter: 280 μm
  - Recoat length: 20 mm
  - Fiber: 125 μm cladding with transparent UV acrylate 250 μm coating diameter, strip length 16 mm
  - Temperature: 25°C
- FGP-20 is manufactured by Nidec-Shimpo Co. Ltd. and not provided by AFL.

continued  
→

## FSR-115, FSR-116 and FSR-117 Optical Fiber Recoaters

### Ordering Information — Recoaters

For a fully operable recoater, required components are: FSR-115/116/117 recoater body (1), FSR-115/116/117 mold (1) and FSR-115/116/117 insert pair (1).

Part numbers below with “Kit” in the description include all three components.

DESCRIPTION	AFL NO.
<b>FSR-115 Recoater Body</b> Includes: FSR-115, ADC-21 AC adapter, ACC-09 AC power cord, FSR-115/116/117 insert shim set, FSR-115/116/117 insert set screws, HEX-04 hex wrench, USB-01 USB Cable, QRG-08-E quick reference guide, and One year factory warranty	S018142
<b>FSR-116 Recoater Body</b> Includes: FSR-116, ADC-21 AC adapter, ACC-09 AC power cord, PC-02 protection cover, FSR-115/116/117 insert shim set, FSR-115/116/117 insert set screws, HEX-04 hex wrench, USB-01 USB Cable, QRG-08-E quick reference guide, and One year factory warranty	S018143
<b>FSR-117 Recoater Body</b> Includes: FSR-117, ADC-21 AC adapter, ACC-09 AC power cord, PC-03 protection cover, FSR-115/116/117 insert shim set, FSR-115/116/117 insert set screws, HEX-04 hex wrench, USB-01 USB Cable, QRG-08-E quick reference guide, and One year factory warranty	S018144
<b>FSR-115 Kit with 280 µm mold and 225-275 µm inserts</b> Includes: FSR-115, 280 µm mold, 225-275 µm inserts, ADC-21 AC adapter, ACC-09 AC power cord, FSR-115/116/117 insert shim set, FSR-115/116/117 insert set screws, HEX-04 hex wrench, USB-01 USB Cable, QRG-08-E quick reference guide, and One year factory warranty	S018170
<b>FSR-116 Kit with 280 µm mold and 225-275 µm inserts</b> Includes: FSR-116, 280 µm mold, 225-275 µm inserts, ADC-21 AC adapter, ACC-09 AC power cord, PC-02 protection cover, FSR-115/116/117 insert shim set, FSR-115/116/117 insert set screws, HEX-04 hex wrench, USB-01 USB Cable, QRG-08-E quick reference guide, and One year factory warranty	S018171
<b>FSR-117 Kit with 280 µm mold and 225-275 µm inserts</b> Includes: FSR-117, 280 µm mold, 225-275 µm inserts, ADC-21 AC adapter, ACC-09 AC power cord, PC-03 protection cover, FSR-115/116/117 insert shim set, FSR-115/116/117 insert set screws, HEX-04 hex wrench, USB-01 USB Cable, QRG-08-E quick reference guide, and One year factory warranty	S018172

### Accessories

DESCRIPTION	AFL NO.
<b>MOLDS</b>	
FSR-115/116/117 195 µm Mold	S018146
FSR-115/116/117 255 µm Mold	S018147
FSR-115/116/117 280 µm Mold	S018145
FSR-115/116/117 320 µm Mold	S018148
FSR-115/116/117 330 µm Mold	S018149
FSR-115/116/117 450 µm Mold	S018150
FSR-115/116/117 600 µm Mold	S018151
FSR-115/116/117 650 µm Mold	S018152
FSR-115/116/117 670 µm Mold	S018153
FSR-115/116/117 850 µm Mold	S018154
FSR-115/116/117 1000 µm Mold	S018155
<b>INSERTS</b>	
FSR-115/116/117 Inserts (90-110 µm fiber coating)	S018156
FSR-115/116/117 Inserts (110-140 µm fiber coating)	S018157
FSR-115/116/117 Inserts (140-180 µm fiber coating)	S018158
FSR-115/116/117 Inserts (180-225 µm fiber coating)	S018159
FSR-115/116/117 Inserts (225-275 µm fiber coating)	S018160
FSR-115/116/117 Inserts (250-350 µm fiber coating)	S018161
FSR-115/116/117 Inserts (350-450 µm fiber coating)	S018162
FSR-115/116/117 Inserts (450-550 µm fiber coating)	S018163
FSR-115/116/117 Inserts (540-660 µm fiber coating)	S018164
FSR-115/116/117 Inserts (660-810 µm fiber coating)	S018165
FSR-115/116/117 Inserts (810-970 µm fiber coating)	S018166

DESCRIPTION	AFL NO.
<b>MISCELLANEOUS</b>	
Protection cover for FSR-116: PC-02	S016107
Protection cover for FSR-117: PC-03	S016108
FSR-115/116/117 Insert Set Screws (QTY: 5)	S018169
FSR-115/116/117 Insert Shim Set	S018167
UV resin bottle: FSR-05-BTL-01	S016112
Force gauge adaptor: FGA-02	S016113
AC adapter ADC-21	S018168
AC power cord ACC-09	S014390

continued  
→

### FSR-115, FSR-116 and FSR-117 Optical Fiber Recoaters

#### New Insert System

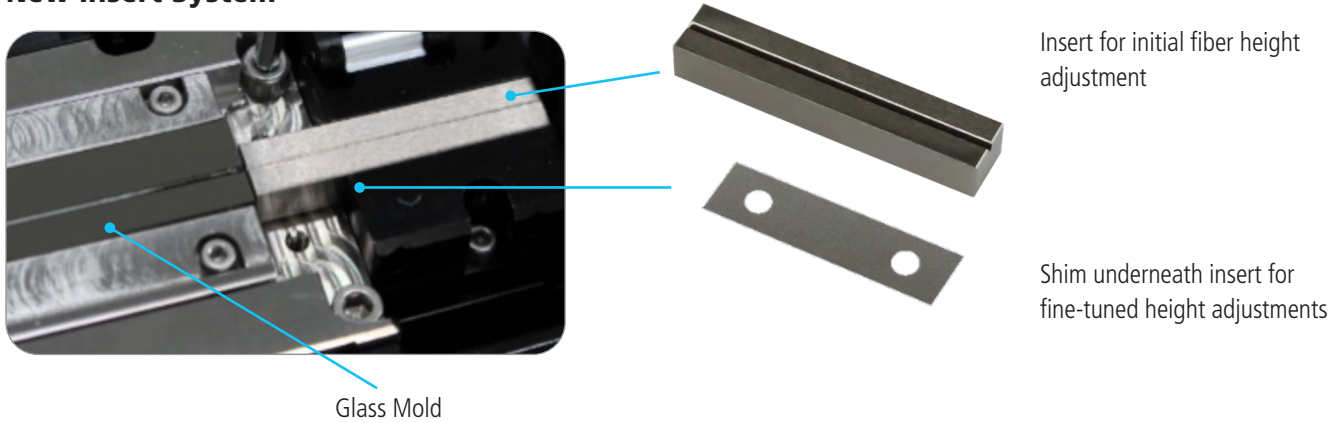

#### Simple. Repeatable. Concentric.

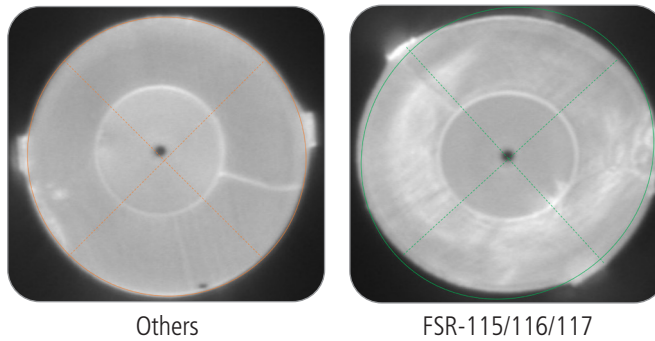

#### Improved Mold Design

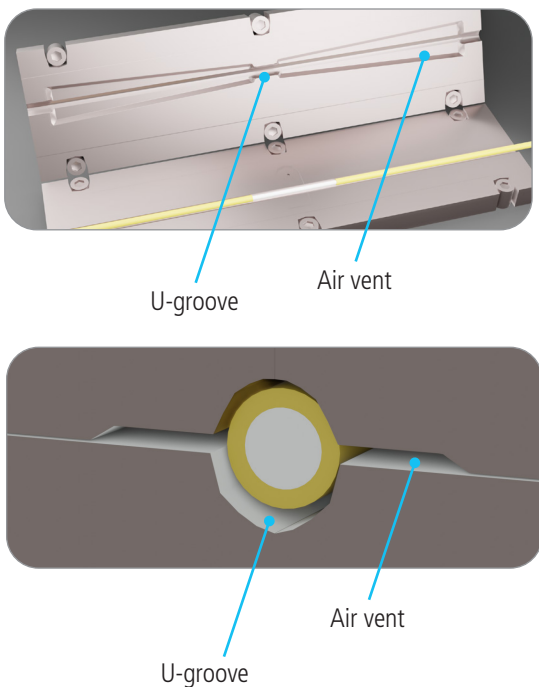

#### Comparison Recoat Length Settings vs. Results<sup>1</sup>

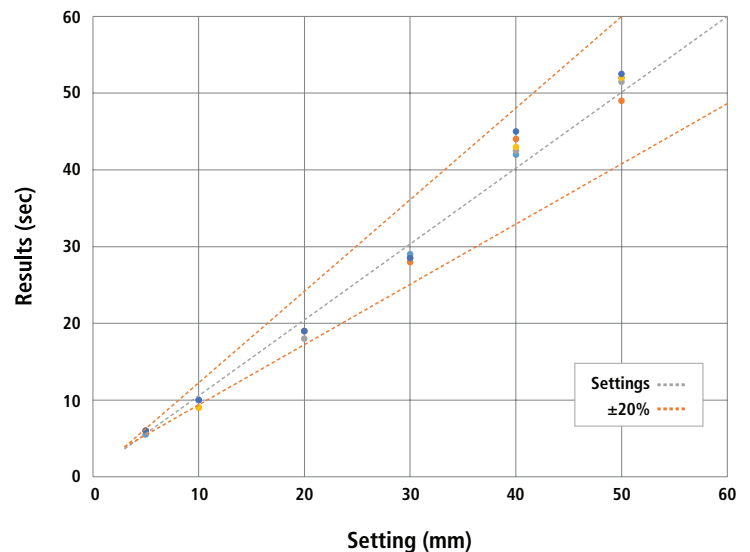

1. The table does not guarantee the recoat length accuracy. Test conditions: (1) UV recoat Resin: Japan Fine Coatings Co., Ltd. 950Y200; (2) Recoat diameter: 280  $\mu$ m; (3) Recoat Length: 10-50 mm; (4) Fiber: Clad Diameter 125  $\mu$ m/Transparent UV 250  $\mu$ m Coating Diameter, Coating Stripping length 60 mm; and (5) Environmental Condition: 25°C

continued  
→



## FSR-115, FSR-116 and FSR-117 Optical Fiber Recoaters

### RFID for Mold Identification by the FSR

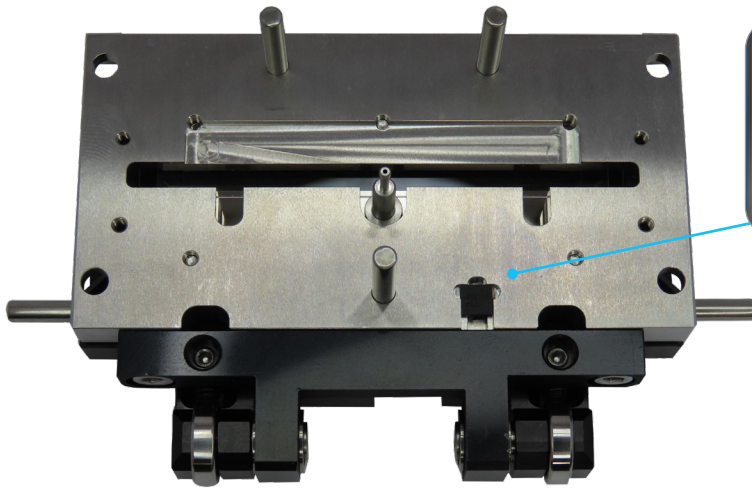

Underside of Mold



RFID Chip

Select Recoat Mode		
19: BASIC 280HI	L=20mm	⚙️
20: SPECIAL 280	L=20mm	⚙️
21: BASIC 280LI	L=20mm	⚙️
22: BASIC 450HI	L=20mm	⚙️
23: BASIC 450HI	L=34mm	⚙️
24: BASIC 450HI	L=12mm	⚙️
25: BASIC 450LI	L=34mm	⚙️

Suggests suitable programs

### Improved Viewing During Injection

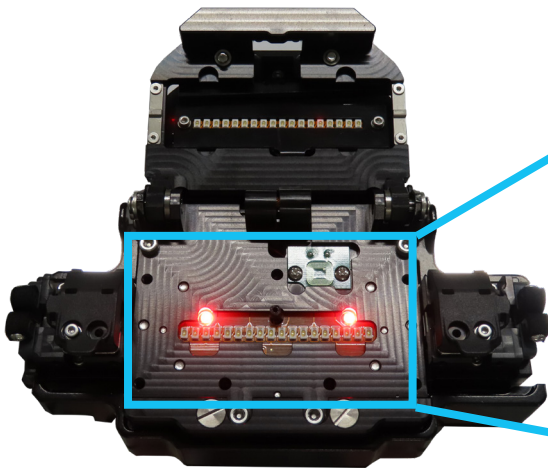

Mold Removed

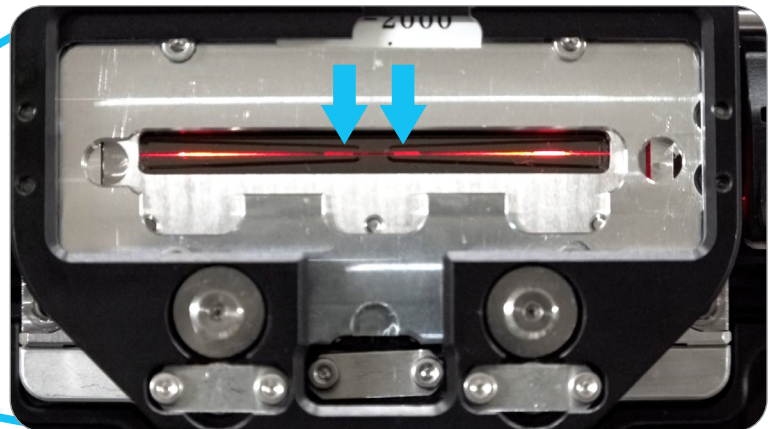

Mold Viewing Window



## Splice Protection Sleeves

AFL offers a wide selection of fiber protection sleeves to meet any application. The FP series is the industry standard for durable and lasting protection of single fiber splices in field installations, while the FP-04(T) and FP-05 provide the same durable protection for 8 and 12 fiber ribbon respectively.

The FPS01 and FPS04 series are specially designed for optical components, where small packaging is a priority. These micro sleeves provide the known reliability of Fujikura sleeves in the smallest possible lengths. This easy and cost effective method is a great alternative to recoating. The FPS01 and FPS04 series offer a wide range of options to accommodate various coating sizes, and are manufactured in a variety of lengths. This gives great flexibility in designing optical modules.

### Standard Sleeves: Dimensions & Applicable Fiber

#### SLEEVES FOR SINGLE FIBERS 250 MICRONS TO 900 MICRONS

DESCRIPTION	SLEEVE LENGTH	FIBER CLEAVE LENGTH	SLEEVE DIAMETER AFTER SHRINK	MOQ & MOM	AFL NO.
FP-40 Slim Protection Sleeve	40 mm	10 mm	2.3 mm (max.)	1,000 & 100	S018262
FP-60 Slim Protection Sleeve	60 mm	10 mm	2.3 mm (max.)	1,000 & 100	S018263
FP-60	60 mm	10 mm	3.1 mm (max.)	1,000 & 100	S015915
FP-40	40 mm	10 mm	3.1 mm (max.)	1,000 & 100	S015916

#### SLEEVES FOR UP TO 250 MICRON COATED RIBBON

DESCRIPTION	FIBER COUNT	SLEEVE LENGTH	FIBER CLEAVE LENGTH	SLEEVE DIAMETER AFTER SHRINK	MOQ & MOM	AFL NO.
FP-04(T)	Up to 8 fibers	40 mm	10 mm	4.0 mm (max.)	250 & 250	S002105
FP-05	Up to 12 fibers	40 mm	10 mm	4.5 X 4.0 mm (max.)	250 & 250	S003027
FP-05-28	Up to 12 fibers	28 mm	10 mm	4.5 mm (max.)	5,000 & 250	S014720
FPS04-30	Up to 4 fibers	30 mm	10 mm	2.4 mm (max.)	250 & 250	S010848
FPS08-28	Up to 8 fibers	28 mm	10 mm	3.3 X 2.7 mm (max.)	500 & 500	S013560
FPS24-40	Up to 24 fibers	40 mm	10 mm	8.0 X 4.0 mm (max.)	200 & 200	S013004

### Specifications

PARAMETER	DESCRIPTION	VALUE
Outer tube	FP-60/40/03 series	Polyolefin based on Polyethylene
	FPS-04(T) / FP-05	Ethylene-Vinyl Acetate
Inner Tube	ALL	Ethylene-Vinyl Acetate
Strength member	FP-60/40/03 series	Stainless steel
	FP-04(T) / FP-05	Heat-resistant glass
Operation condition (after shrink)		-10 to 50°C, 0 to 95% RH (Non dew)
Storage condition (before shrink)		-40 to 60°C, Non dew

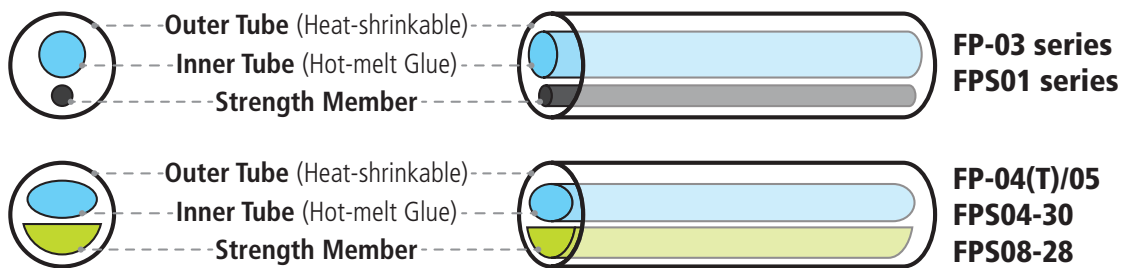

## Splice Protection Sleeves

### Micro Sleeves: Dimensions & Applicable Fiber

#### FPS01-400 SERIES FOR SINGLE FIBERS UP TO 400 MICRON FIBER

DESCRIPTION	SLEEVE LENGTH	FIBER CLEAVE LENGTH	SLEEVE DIAMETER AFTER SHRINK	PACKAGING	AFL NO.
FPS01-400-12	12 mm	4 mm	1.5 mm	50 Pack	S014088
FPS01-400-15	15 mm	5 mm	1.5 mm	50 Pack	S012668
FPS01-400-20	20 mm	8 mm	1.5 mm	50 Pack	S012672
FPS01-400-25	25 mm	10 mm	1.5 mm	50 Pack	S012676
FPS01-400-34	34 mm	15 mm	1.5 mm	50 Pack	S012680
FPS01-400-40	40 mm	16 mm	1.5 mm	1,250 Box	S011914

#### FPS01-900 SERIES FOR SINGLE FIBERS UP TO 900 MICRON FIBER

DESCRIPTION	SLEEVE LENGTH	FIBER CLEAVE LENGTH	SLEEVE DIAMETER AFTER SHRINK	PACKAGING	AFL NO.
FPS01-900-15	15 mm	4 mm	2.3 mm	50 Pack	S012684
FPS01-900-20	20 mm	6 mm	2.3 mm	50 Pack	S012688
FPS01-900-25	25 mm	6 mm	2.3 mm	50 Pack	S011954
FPS01-900-34	34 mm	13 mm	2.3 mm	50 Pack	S012692
FPS01-900-45	45 mm	16 mm	2.3 mm	50 Pack	S012696

### Specifications

PARAMETER	DESCRIPTION	VALUE
Outer tube	FPS01 series / FPS04-30 / FPS08-28 / FPS24-40	Polyolefin based on Polyethylene
Inner Tube	ALL	Ethylene-Vinyl Acetate
Strength member	FPS01 series	Stainless steel
	FPS04-30 / FPS08-28 / FPS24-40	Heat-resistant glass
Operation condition (after shrink)		-10 to 50°C, 0 to 95% RH (Non dew)
Storage condition (before shrink)		-40 to 60°C, Non dew

### Type Variations





Bluetooth



Shown in CC-37 Carrying Case

### Features

- Motorized blade rotation
- Bluetooth communication
- Shock resistant
- Simple one-step operation
- 60,000 cleave blade life
- Field serviceable



## CT52 Fiber Cleaver

The CT52 cleaver is designed for use with Fujikura factory model fusion splicers. Modified clamping pads on the CT52 allow for shorter cleave lengths with fiber coating >250 µm. The CT52 provides unprecedented durability and simplistic maintenance unseen with any other cleaver. Cleaver blade life is easily managed and maximized via Bluetooth connection with a convenient smartphone app. Incorporating motorized push-button blade rotation and a convenient thumbwheel for blade height adjustment, routine cleaver adjustments have never been easier! The 16 position blade yields 60,000 cleaves providing for extended intervals between blade replacement. The CT52 is designed for use with either Fujikura FH-100 or FH-70 series fiber holders, but can also be used with the optional adapter plate to eliminate the need for fiber holders if desired. When utilized with the optional spacers for the cleaver and RS series thermal stripper, six different cleave lengths can be easily attained.

### Specifications

ITEM		VALUE
Applicable Fiber	Fiber type	Single mode optical fiber Multi mode optical fiber
	Fiber count	Up to 12 fiber ribbon
	Cladding dia.	Approx. 125 µm
Applicable Coating	Fiber plate	AD-10-M24 : Max. 900 µm coating diameter AD-50 : Max. 3 mm coating diameter
	Fiber holder	Coating shape. : Refer to splicer fiber holder options
Cleave Length	Fiber plate	CD = Coating Diameter AD-10-M24 3 to 20 mm for CD ≤ 250 µm 8 to 20 mm for CD 251 – 400 µm AD-50 CD= 250 µm or less : 3 to 20mm 250 µm < CD < 1000 µm : 8 to 20 mm 1000 µm < CD < 3 mm : 14 to 20 mm
	Fiber holder	See Cleaver Selection table on next page
Cleave Angle	Single fiber	Avg. 0.3 to 0.9 degrees
	Fiber ribbon	Avg. 0.3 to 1.2 degrees
Blade Life		Approx. 60,000 fiber cleaves
Physical description	Dimensions W	Approx. 120 mm when closing the lever
	Dimensions D	Approx. 95 mm when closing the lever
	Dimensions H	Approx. 58 mm when closing the lever
	Weight	Approx. 305 g including battery and AD-10-M24
Environmental condition	Temperature	Operate : -10 to 50°C Storage : -40 to 80°C
	Humidity	Operate : 0 to 95% non-condensing Storage : 0 to 95% non-condensing
Battery		2 pieces of LR03/AAA dry battery
Wireless interface		Bluetooth 4.1 LE
Screw hole for tripod		1/4-20UNC
Other features	Blade rotation	Motorized rotation
		Manual rotation dial
	Replaceable parts	Blade
Clamp arm		

## CT52 Fiber Cleaver

### Cleaver Selection

STRIPPER	CLEAVER	CLEAVE LENGTH
RS02/03	CT52/58 with SPA-CT08-08	3 mm
RS02/03 with SPA-RS02-08	CT52/58 with SPA-CT08-08	8 mm
HTS-12	CT52/58 with SPA-CT08-09	4 mm
SS03	CT52/58 with SPA-CT08-09	9 mm
	CT52/58 with SPA-CT08-010	5 mm
		10 mm

### Ordering Information

DESCRIPTION	APPLICATION	AFL NO.
<b>CT52</b> <b>Includes:</b> CT52 cleaver, SPA-CT08-09 cleaver spacer, hex wrench, carrying case and instruction manual	Single Fibers: 125 µm cladding	S017078

### Accessories

DESCRIPTION	AFL NO.
CB-08 Replacement Blade	S017076
CC-37 Transit Case	S017077
AD-10-M24 Adapter Plate	S017335
SPA-CT08-10 Spacer	S017011
SPA-CT08-09 Spacer	S017390
SPA-CT08-08 Spacer	S017391
ARM-CT52-01 Replacement Arm Set	S017388
FDB-05 Fiber Dust Box	S017121
BRW-CT08-01 Blade Rotary Wheel	S017110
SC-CT50-01 Side Cover	S017108

**Splice+** is a smartphone application that works in cooperation with Fujikura's splicers, cleavers and ribbon fiber strippers which have Bluetooth capability.

Get the **Splice+** app at the Apple App store or at Google Play.





Shown in CC-37 Carrying Case

### Features

- Motorized blade rotation
- Bluetooth communication
- Shock resistant
- Simple one-step operation
- 60,000 cleave blade life
- Field serviceable



## CT58 Fiber Cleaver

The CT58 cleaver is designed specifically for cleaving silica fibers with 80 μm cladding and up to 400 μm coatings. The CT58 provides unprecedented durability and simplistic maintenance unseen with any other cleaver. Cleaver blade life is easily managed and maximized via Bluetooth connection with a convenient smartphone app. Incorporating motorized push-button blade rotation and a convenient thumbwheel for blade height adjustment, routine cleaver adjustments have never been easier! The 16 position blade yields 60,000 cleaves providing for extended intervals between blade replacement. The CT58 is designed for use with either Fujikura FH-100 or FH-70 series fiber holders, but can also be used with the optional adapter plate to eliminate the need for fiber holders if desired. When utilized with the optional spacers for the cleaver and RS03-80 thermal stripper, six different cleave lengths can be easily attained.

### Specifications

ITEM	VALUE	
Applicable Fiber	Fiber type	Single mode optical fiber Multi mode optical fiber
	Fiber count	Single
	Cladding dia.	Approx. 80 μm
Applicable Coating	Fiber plate	AD-10-M24 : Max. 400 μm coating diameter AD-50 : Max. 400 μm coating diameter
	Fiber holder	Coating shape. : Refer to splicer fiber holder options
Cleave Length	Fiber plate	CD = Coating Diameter AD-10-M24 3 to 20 mm for CD ≤ 250 μm 8 to 20 mm for CD 251 – 400 μm AD-50 CD= 250 μm or less : 3 to 20 mm 250 μm < CD < 400 μm : 8 to 20 mm
	Fiber holder	See Cleaver Selection table on next page
Cleave Angle	Single fiber	Avg. 0.3 to 0.9 degrees
Blade Life	Approx. 60,000 fiber cleaves	
Physical description	Dimensions W	Approx. 90 mm when closing the lever
	Dimensions D	Approx. 95 mm when closing the lever
	Dimensions H	Approx. 58 mm when closing the lever
	Weight	Approx. 265 g
Environmental condition	Temperature	Operate : -10 to 50°C Storage : -40 to 80°C
	Humidity	Operate : 0 to 95% non-condensing Storage : 0 to 95% non-condensing
Battery	2 pieces of LR03/AAA dry battery	
Wireless interface	Bluetooth 4.1 LE	
Screw hole for tripod	1/4-20UNC	
Other features	Blade rotation	Motorized rotation Manual rotation dial
	Replaceable parts	Blade
		Clamp arm

## CT58 Fiber Cleaver

### Cleaver Selection

STRIPPER	CLEAVER	CLEAVE LENGTH
RS02/03	CT52/58 with SPA-CT08-08	3 mm
RS02/03 with SPA-RS02-08		8 mm
HTS-12	RS02/03 with SPA-CT08-09	4 mm
	RS02/03 with SPA-CT08-09	9 mm
SS03	RS02/03 with SPA-CT08-10	5 mm
	RS02/03 with SPA-CT08-10	10 mm

### Ordering Information

DESCRIPTION	APPLICATION	AFL NO.
<b>CT58</b> <b>Includes:</b> CT58 cleaver, SPA-CT08-09 cleaver spacer, hex wrench, carrying case and instruction manual	Single Fibers: 80 µm cladding	S017097

### Accessories

DESCRIPTION	AFL NO.
CB-08 Replacement Blade	S017076
CC-37 Transit Case	S017077
AD-10-M24 Adapter Plate	S017335
SPA-CT08-10 Spacer	S017011
SPA-CT08-09 Spacer	S017390
SPA-CT08-08 Spacer	S017391
ARM-CT58-01 Replacement Arm Set	S017389
BRW-CT08-01 Blade Rotary Wheel	S017110
SC-CT50-01 Side Cover	S017108

**Splice+** is a smartphone application that works in cooperation with Fujikura's splicers, cleavers and ribbon fiber strippers which have Bluetooth capability.

Get the **Splice+** app at the Apple App store or at Google Play.







## CT-114, CT-115 and CT-116 Fiber Cleavers

Fujikura’s lineup of high-quality, large diameter optical fiber cleavers is built to achieve low cleave angles with pristine end-faces for a vast array of fiber types. These cleavers are heavily utilized in fiber preparation for fusion splicing of standard data communication fibers, octagonal or round large diameter fibers (LDF), polarization maintaining fibers, photonic crystal fibers and even component manufacturing with capillary tubes, ball lenses, end caps and more.

Automation was a key theme during design of these products. The aim was to enable smarter, faster and more reliable decisions than previously capable via operator trial and error. Leveraging the success of their predecessors, the CT-115 and CT-116 fiber clamps will automatically adjust the clamping force to provide the most optimal cleave angle for any fiber in the machine. The fiber backstop position is newly automated to find the optimum location for best cleave angle performance. Microns adjustments can make the difference in achieving required cleave angles for many fibers. As a manual process, this is very difficult to optimize, but this new automation removes this painstaking process. With the unheard-of long blade life of all three cleavers, blade position changes are infrequent, but when needed, the blade will index to the next position automatically, driven by a motorized blade assembly.



CT-115

As an industry first, this generation LDF cleaver has an RFID sensor which matches the RFID tag on every FH-110 series fiber holder. These cleavers have a new fiber holder management menu where users can pair a fiber holder to a cleave mode. In this menu, each fiber holder has a unique RFID and a user defined name for simple setup of fiber holder and cleave mode combinations. The cleaver utilizes the pairings in this menu to automatically change the cleave mode based on the fiber holder recognized by the cleaver’s RFID sensor. This can be used as either a process control measure, or to aid in cleave optimization.



CT-116

This line of LDF cleavers brings exciting benefits to the specialty fiber optic industry, which promise to yield tangible benefits to its users. Fujikura continues to lead with innovation and value in the quality solutions they develop. Put our LDF cleavers to the test by contacting us at 1-800-235-3423.

*continued*  
→

## CT-114, CT-115 and CT-116 Fiber Cleavers

### CT-114 Features

- 80-660  $\mu\text{m}$  cladding diameter
- Automatic blade position change
- RFID fiber holder identification
- Manual fiber clamping and backstop adjustment
- 200,000 cleaves per blade for 250  $\mu\text{m}$  fiber
- PC software and manual downloadable via USB



### Angled Cleaving

Angled cleaving up to 15° (only CT-116)

### CT-115 Features

- 80-1,250  $\mu\text{m}$  cladding diameter
- Automatic fiber clamping, backstop adjustment and blade position change
- RFID fiber holder identification
- 200,000 cleaves per blade for 250  $\mu\text{m}$  fiber
- PC software and manual downloadable via USB

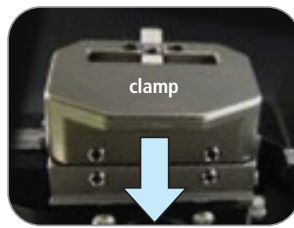

### Automatic Clamp Function

CT-115 and CT-116 self-optimizes and applies the clamp force automatically for best cleave results without trial and error.

### CT-116 Features

- 80-1,250  $\mu\text{m}$  cladding diameter
- Automatic fiber clamping, backstop adjustment and blade position change
- RFID fiber holder identification
- 200,000 cleaves per blade for 250  $\mu\text{m}$  fiber
- Angled cleaving function (up to 15°)
- PC software and manual downloadable via USB



### Backstop

CT-115 and CT-116 automated backstop prevents time and fiber waste with self-optimized positioning for best cleave results.

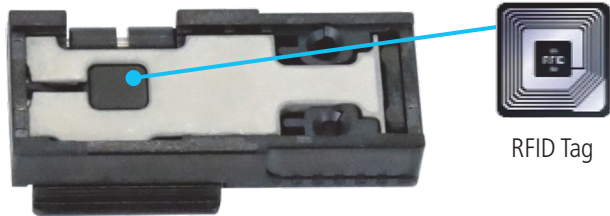

RFID Tag

### RFID Fiber Holder System

RFID identification with FH-110 series fiber holders improves quality control in manufacturing and when changing applications in an R&D environment.



### Automatic Blade Position Change

Cleaver blade position indexing driven by a motor to remove user error from this critical process.

*continued*  
→

## CT-114, CT-115 and CT-116 Fiber Cleavers

### Specifications

PARAMETER	CT-114	CT-115	CT-116
Fiber type	Silica optical fibers and capillary tubes		
Fiber count	Single		
Cladding diameter	80-660 $\mu\text{m}$	80-1,250 $\mu\text{m}$	
Coating diameter	81-3,182 $\mu\text{m}$		
Fiber clamping	Manual <sup>1</sup>	Automatic via motor	
Backstop adjustment	Manual	Automatic via motor	
Tension range <sup>2</sup>	0 to 3,000 gf (29.4 N)	0 to 10,000 gf (98.1 N)	
Cleaving length <sup>3</sup>	30-75 mm		
Cleaving angle	Average 0.2° (Cladding diameter 125 $\mu\text{m}$ )		
	Average 0.3° (Cladding diameter 400 $\mu\text{m}$ )		
	Average 0.4° (Cladding diameter 660 $\mu\text{m}$ ) <sup>5</sup>	Average 1.0° (Cladding diameter 1,000 $\mu\text{m}$ ) <sup>5</sup>	
Angled cleaving	–	–	0-15° (0 to 180° on cleaver rotator) <sup>6</sup>
Blade life <sup>7</sup>	200,000 fibers (10,000 fibers x 20 positions for 250 $\mu\text{m}$ cladding fiber)		
Dimensions (WxDxH)	240 x 133 x 142 mm without projections		240 x 133 x 151 mm without projections
Weight	3.6 kg without inserts and with fiber holder adapter	3.9 kg without inserts and with fiber holder adapter	4.2 kg without inserts and with fiber holder adapter
Humidity	0 to 95% RH, non-condensing (operation and storage)		
Temperature	0°C to 40°C (operation) -40°C to 80°C (storage)		
Number of cleaving modes	Maximum 100		
Cleave results	10,000 cleave data		
AC Adapter	Input: AC 100 V to 240 V (50 or 60 Hz) (max. 1.5 A) Output: DC 19 V, Max. 2.1 A		
Display	TFT 4.95" touch screen LCD monitor		
Interface	PC	USB 2.0 (Mini-B type) for PC communication	
	Ground point	Applicable by M3 size truss screw	
Wireless communication	RFID	Compliant with ISO 15693	
Other Features	Automatic Functions	Automatic cleave mode selection via RFID tag	
		Motorized blade position change	
		Automatic tension adjustment	
PC Software	Firmware update via internet		
	Cleave mode and parameter upload and download		

#### Notes:

1. For cladding diameter less than 400  $\mu\text{m}$ , use magnets. For cladding diameter 400-660  $\mu\text{m}$ , use both magnets and clamp lid screw. Clamp lid screw may be necessary depending on the fiber type when it is also under 400  $\mu\text{m}$ .
2. There are some cases where the set tension is different from the actual tension.
3. Cleave length is defined as the distance between the left-side fiber clamp and the end-face of the cleaved fiber.
4. Measured with an interferometer at room temperature. A new blade was used to cleave each fiber. The average cleave angle changes depending on operational conditions such as blade condition, operation method and cleanliness.
5. Measured with an FSM-100P+ splicer at room temperature. A new blade was used to cleave each fiber. The average cleave angle changes depending on operational conditions such as blade condition, operating method and cleanliness.
6. Maximum angled cleave changes depending on the fiber type cleaved and clamp position.
7. The blade life changes depending on the operational conditions such as blade condition, operating method, cleanliness and fiber type cleaved.

continued  
→

## CT-114, CT-115 and CT-116 Fiber Cleavers

### Ordering Information

DESCRIPTION	AFL NO.
<b>CT-114 LDF Cleaver</b> includes: ADC-21 AC adapter; ACC-09 AC power cord; FHA-CT115 fiber holder adapter; CM-CT115 fiber height mirror; x3 each SPA-CT105-30, 50 and 100 shims; x15 set screws for inserts; HEX-01 hex wrench; USB-01 USB Cable; TR-CT115-E Technical reference manual; and One year factory warranty	S018182
<b>CT-115 LDF Cleaver</b> includes: ADC-21 AC adapter; ACC-09 AC power cord; FHA-CT115 fiber holder adapter; CM-CT115 fiber height mirror; x3 each SPA-CT105-30, 50 and 100 shims; x15 set screws for inserts; HEX-01 hex wrench; USB-01 USB Cable; TR-CT115-E Technical reference manual; and One year factory warranty	S018183
<b>CT-116 Angled LDF Cleaver</b> includes: ADC-21 AC adapter; ACC-09 AC power cord; FHA-CT115 fiber holder adapter; CM-CT115 fiber height mirror; x3 each SPA-CT105-30, 50 and 100 shims; x15 set screws for inserts; HEX-01 hex wrench; USB-01 USB Cable; TR-CT115-E Technical reference manual; and One year factory warranty	S018184

### Accessories

DESCRIPTION	AFL NO.
<b>Fiber Holder Inserts</b>	
Master fiber holder insert kit (includes upper and lower inserts from 80-1750)	S016098
INSERT-L-80	S016085
INSERT-L-125	S016086
INSERT-L-160	S016087
INSERT-L-250	S016088
INSERT-L-400	S016089
INSERT-L-500-750	S016090

DESCRIPTION	AFL NO.
<b>Fiber Holder Inserts (continued)</b>	
INSERT-L-1000-1250	S016091
INSERT-L-1500-1750	S016092
INSERT-L-2000-2250	S016093
INSERT-L-2500-3000	S016094
INSERT-U-80-400	S016079
INSERT-U-500-750	S016080
INSERT-U-1000-1250	S016081
INSERT-U-1500-1750	S016082
INSERT-U-2000-2250	S016083
INSERT-U-2500-3000	S016084

DESCRIPTION	AFL NO.
<b>Height adjusting shim (10-piece pack)</b>	
SPA-CT105-30 (30 µm)	S016095
SPA-CT105-50 (50 µm)	S016096
SPA-CT105-100 (100 µm)	S016097
<b>Miscellaneous Items</b>	
FHA-CT115 Fiber holder adapter	S018211
CM-CT115 Fiber height mirror	S018212
TD-01 Torque Driver	S016738
CB-06A Replacement Blade	S016078
AC adapter ADC-21	S018168
AC power cord ACC-09	S014390

### Fiber Holders

DESCRIPTION	AFL NO.
FH-110-60 Fiber Holder	S018215
FH-110-100 Fiber Holder	S018216
FH-110-125 Fiber Holder	S018217
FH-110-150 Fiber Holder	S018218
FH-110-180 Fiber Holder	S018219
FH-110-210 Fiber Holder	S018220
FH-110-250 Fiber Holder	S018221
FH-110-300 Fiber Holder	S018222
FH-110-350 Fiber Holder	S018223
FH-110-400 Fiber Holder	S018224
FH-110-500 Fiber Holder	S018225
FH-110-600 Fiber Holder	S018226
FH-110-700 Fiber Holder	S018227

DESCRIPTION	AFL NO.
FH-110-800 Fiber Holder	S018228
FH-110-900 Fiber Holder	S018229
FH-110-1000 Fiber Holder	S018230
FH-110-1100 Fiber Holder	S018231
FH-110-1200 Fiber Holder	S018232
FH-110-1300 Fiber Holder	S018233
FH-110-1400 Fiber Holder	S018234
FH-110-1500 Fiber Holder	S018235
FH-110-1600 Fiber Holder	S018236
FH-110-1700 Fiber Holder	S018237
FH-110-1800 Fiber Holder	S018238
FH-110-1900 Fiber Holder	S018239
FH-110-2000 Fiber Holder	S018240

continued  
→

## CT-114, CT-115 and CT-116 Fiber Cleavers

### Insert Selection Guide

LOWER INSERT	UPPER INSERT											
	INSERT-U-80-400	INSERT-U-500-750 <sup>1</sup>		INSERT-U-1000-1250 <sup>1</sup>		INSERT-U-1500-1750 <sup>1</sup>		INSERT-U-2000-2250 <sup>1</sup>		INSERT-U-2500-3000 <sup>1</sup>		
		500	750	1000	1250	1500	1750	2000	2250	2500	3000	
INSERT-L-80	54-107											
INSERT-L-125	84-167											
INSERT-L-160	115-213											
INSERT-L-250	167-333											
INSERT-L-400	267-533	400-533										
INSERT-L-500-750 <sup>1</sup>	500	334-667	467-667	550-667								
	750		634-868	717-1000	787-1000							
INSERT-L-1000-1250 <sup>1</sup>	1000			884-1118	954-1188	1037-1272						
	1250					1120-1355	1204-1438	1287-1522				
INSERT-L-1500-1750 <sup>1</sup>	1500					1370-1605	1454-1688	1537-1772				
	1750							1620-1855	1704-1938	1780-2015		
INSERT-L-2000-2250 <sup>1</sup>	2000							1870-2115	1947-2288	2030-2265		
	2250								2114-2348	2197-2432	2280-2515	
INSERT-L-2500-3000 <sup>1</sup>	2500									2364-2598	2447-2682	2614-2848
	3000										2780-3015	2947-3182

**Note:**

1. Each side of this insert is equipped with a groove that is marked with the size of the fiber diameter on the table.

### Upper and lower inserts can be changed up or down depending on required fiber fit into the V-groove.

Inserts 500 μm and above are double-sided. Therefore, the visible label when inserted indicates the size of the insert you are using.

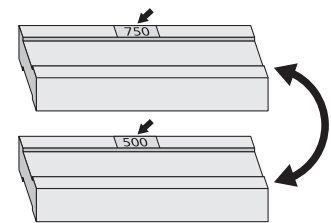

### Upper and lower inserts are necessary for both left and right side clamps.

Case 1: Cleaving coating-stripped fiber

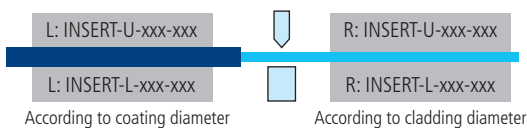

Inserts according to both coating diameter and cladding diameter are necessary.

Case 2: Cleaving glass rod

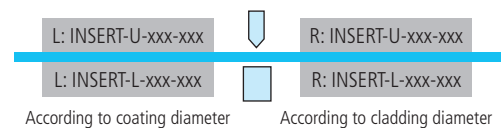

Two insert pairs of the same size according to rod diameter are necessary.



## CT-110 and CT-111 Tension-Method Fiber Cleavers

The CT-110 tension-method cleaver and CT-111 tension-method cleaver with additional angled cleaving features are built to provide precision cleaves for a vast array of fiber types. These cleavers are heavily relied upon for fiber preparation of standard data communication fibers, polarization maintaining fibers, photonic crystal fibers, and even component manufacturing of ball lenses, end caps, and more. Leveraging the success of their predecessors, the CT-110 and CT-111 achieve industry leading performance in a small form factor, and with the option to operate cordless. With the industry leading blade life of both cleavers, blade position changes are infrequent, but when needed, the blade will index to the next position automatically driven by a motorized blade assembly. A record of the cleave count by blade position is displayed via the accompanying PC software for maximizing blade life.

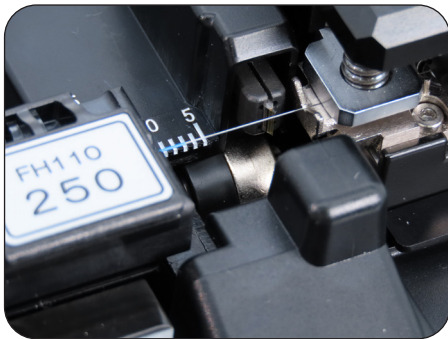

CT-110 Blade

As an industry first, these tension-method cleavers possess an RFID sensor which matches the RFID tag on the new FH-110 series fiber holders. The PC software for these cleavers has a new fiber holder management menu, where users can pair a fiber holder to a cleave mode. In this menu, each fiber holder's unique RFID and user defined name are used for assigning fiber holder and cleave mode combinations. The cleaver utilizes the assignments in this menu to automatically change the cleave mode based on the fiber holder recognized by the cleaver's RFID sensor. This can be used as either a process control measure, or to aid in cleave optimization. Cleave mode parameters can also be edited, uploaded, or downloaded to & from the cleaver via this software.

This category of tension-method cleavers brings exciting benefits to the specialty fiber optic industry. Fujikura continues to lead with innovation and value in the quality solutions they develop. Put our cleavers to the test by contacting us at 1-800-235-3423.



### Features

- RFID fiber holder identification and cleave mode selection
- Lightweight and cordless operation
- Motorized blade changes with no manual disassembly or adjustments
- Angled cleaves up to 15 degrees with CT-111
- Fine-tuned coating and total length adjustments post-cleave
- Tension digitally adjusted and automatically applied according to cleave mode
- PC Software for blade & fiber holder management downloaded from CT-110/111

*continued*  
→



## CT-110 and CT-111 Tension-Method Fiber Cleavers

### Specifications

PARAMETER		CT-110	CT-111
Applicable Fiber	Fiber Type	Silica Fiber	
	Fiber Count	Single Fiber	
	Cladding Diameter	80 to 250 µm	
	Coating Diameter	81 to 2,000 µm	
Applicable Fiber Holder		FH-100, FH-110, and optional FH-70 series <sup>1</sup>	
Tension range <sup>2</sup>		0 to 900 gf	
Total fiber length <sup>3</sup>		Approx. 11-44 mm	
Cleave angle <sup>4</sup>		Average 0.3° for 125 µm cladding diameter	
Angled cleaving		N/A	Approx 0° to 15°
Blade life <sup>5</sup>		Approx. 200,000 fiber cleaves for cladding diameter 250 µm	
Physical	Width	Approx. 140 mm without protrusions	
	Depth	Approx. 106 mm without protrusions	
	Height	Approx. 103.5 mm without protrusions	
	Weight	Approx. 810g without batteries	Approx. 850g without batteries
Environmental Conditions	Temperature	Operate: 0°C to 40°C	
		Storage: -40°C to 80°C	
	Humidity	Operate: 0 to 95% RH non-condensing	
		Storage: 0 to 95% RH non-condensing	
AC Adapter	Input	AC 100V to 240V, 50/60 Hz, Max. 1.5A	
	Output	Approx. DC 19V, Max 2.1A	
Battery	Type	X4 AA batteries (ANSI AA / IEC LR6)	
	Life	Approx. 250 fiber cleaves with standard 125 µm cladding dia. at 25°C	
Connection Terminals	PC	USB 2.0 Mini Type-B <sup>7</sup>	
	Ground	Applicable by M3 truss screw	
Wireless Communication	RFID	Compliant with ISO 15693 <sup>7</sup>	
PC Software		Firmware update via internet	
		Cleave mode edit, upload, download and export	

#### Notes:

1. Holder Adapter Plate (AD-CT110-FH70) is necessary to use FH-70 series holders.
2. There are some cases where the set tension is different than actual tension.
3. Total fiber length is the distance between cleaved fiber end-face and the nearest leading edge of the fiber holder.
4. Measured with an interferometer at room temperature, not with a splicer. The average cleave angle changes depending on the environmental conditions, blade condition, operating method, and cleanliness.
5. Maximum cleave angle changes depending on the fiber type and clamp position.
6. Supports 10,000 cleaves per position at cladding dia. 250 µm. 20 positions x 10,000 cleaves = 200,000 cleaves. The blade life changes depending on the environmental conditions, operating method, and the fiber type.
7. Unavailable with battery.

continued  
→

## CT-110 and CT-111 Tension-Method Fiber Cleavers

### Ordering Information

DESCRIPTION	AFL NO.
<b>CT-110 Tension-Method Fiber Cleaver</b> includes: ADC-21 AC Adapter, ACC—09 power cord, USB cable, two hex wrenches, instruction manual stored on cleaver, quick reference guide, and 1 year factory warranty.	S018320
<b>CT-111 Tension-Method Angled Fiber Cleaver</b> includes: ADC-21 AC Adapter, ACC—09 power cord, USB cable, two hex wrenches, instruction manual stored on cleaver, quick reference guide, and 1 year factory warranty.	S018321
CB-06A Replacement Blade	S016078
FH-70 series adapter plate (AD-CT110-FH70)	S018322
ADC-21 AC Adapter	S018168
ACC-09 Power Cord	S014390

### Fiber Holders

DESCRIPTION	AFL NO.
FH-110-60 Fiber Holder	S018215
FH-110-100 Fiber Holder	S018216
FH-110-125 Fiber Holder	S018217
FH-110-150 Fiber Holder	S018218
FH-110-180 Fiber Holder	S018219
FH-110-210 Fiber Holder	S018220
FH-110-250 Fiber Holder	S018221
FH-110-300 Fiber Holder	S018222
FH-110-350 Fiber Holder	S018223
FH-110-400 Fiber Holder	S018224
FH-110-500 Fiber Holder	S018225
FH-110-600 Fiber Holder	S018226
FH-110-700 Fiber Holder	S018227

DESCRIPTION	AFL NO.
FH-110-800 Fiber Holder	S018228
FH-110-900 Fiber Holder	S018229
FH-110-1000 Fiber Holder	S018230
FH-110-1100 Fiber Holder	S018231
FH-110-1200 Fiber Holder	S018232
FH-110-1300 Fiber Holder	S018233
FH-110-1400 Fiber Holder	S018234
FH-110-1500 Fiber Holder	S018235
FH-110-1600 Fiber Holder	S018236
FH-110-1700 Fiber Holder	S018237
FH-110-1800 Fiber Holder	S018238
FH-110-1900 Fiber Holder	S018239
FH-110-2000 Fiber Holder	S018240



## PowerCleave®

To complement the line of world class splicing systems, AFL’s PowerCleave combines the precision of an ultrasonic cleaver with the ease and improved fiber management of the Fujikura fiber holder system. The PowerCleave utilizes the tensile stress method to avoid touching or damaging the bare glass surface during cleaving, ensuring highly robust, reliable and durable splice results. The PowerCleave provides consistent flat ends even at cleave lengths as short as 3 mm. Specially designed for use with Fujikura’s specialty market splicers, this advanced cleaving system allows for more reliability and greater splicing consistency with less dependence on operator technique.

### Features

- Tensile cleaving with ultrasonic blade
- Consistent, low-angle cleaves of short cleave-length fibers
- Fiber holder system reduces fiber handling
- Clean, reliable quality

### Specifications

PARAMETER	VALUE
Fibers Cleaved	80 μm - 200 μm (cladding diameter)
Minimum Cleave Length	3 mm
Cleave Angle	<0.6 typical
Blade	Diamond with an estimated life of over 20,000 cleaves
Clamping System	Compatible with Fujikura specialty market fiber holder systems
Case	ABS impact resistant with non-slip feet and a 6.25 mm (.24 inch) BSW thread tripod mount for hard mounting to a workstation
Battery	9V alkaline (MN 1604), battery life approximately 10,000 cleaves
Dimensions (L x W x D)	75 mm x 153 mm x 150 mm (3.0 x 6.0 x 5.9 inches)
Weight	1.1 kg (2.4 lbs)
Operating Temperature	0°C to 45°C (32°F to 113°F)
Storage Temperature	-20°C to 60°C (-4°F to 140°F)

### Ordering Information

DESCRIPTION	AFL NO.
<b>PowerCleave Kit</b> Includes: PowerCleave, Instruction manual, 2.5 mm x 60 mm Screwdriver and 2 mm Allen wrench	S009972

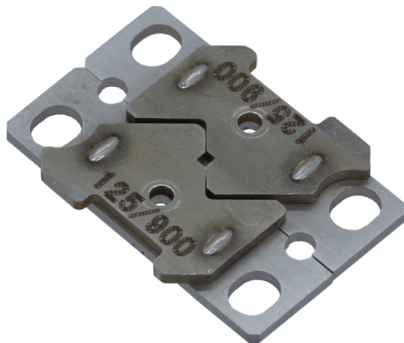
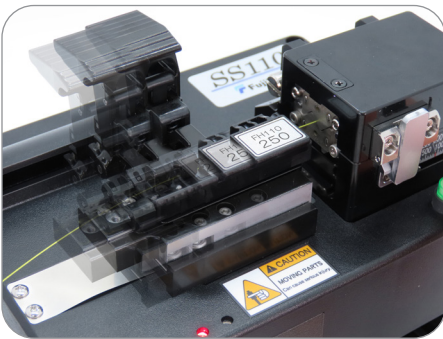
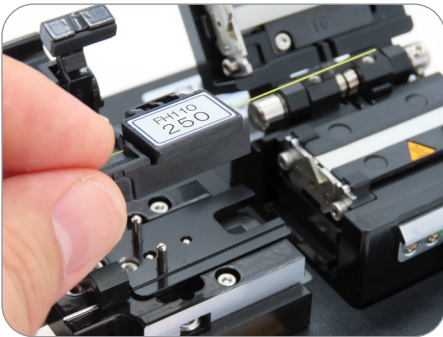

## SS-110 Specialty Fiber Stripper

The Fujikura SS-110 specialty fiber stripper is designed for high reliability fiber splicing in several applications. The centralizing features of the replaceable blades position the optical fiber to both prevent contact of the blades with the fiber cladding and sufficiently remove the fiber coating in one pass. This prevents damage to the glass and leaves little to no debris behind for easy cleaning. In addition, the combined centralizing and blade assembly removes the need for an external guide, making replacement or exchange of the blades quick and simple. Temperature, time, stripping length, and the motorized pull speed are adjustable to optimize thermal stripping for a variety of buffer materials and sizes.

As an industry first, this thermal stripper has an RFID sensor which matches the RFID tag on every FH-110 series fiber holder. This tag and sensor are tied to a new fiber holder management capability in the SS-110. Users can pair a fiber holder to a thermal stripping mode via PC software. Each fiber holder has a unique RFID and a user defined name for simple setup of fiber holder and thermal stripping mode combinations. The SS-110 utilizes the pairings setup in the PC software to automatically change the thermal stripping mode based on the fiber holder recognized by the SS-110's RFID sensor. This can be used as either a process control measure, or to aid in thermal stripping optimizations.

This specialty thermal stripper brings exciting benefits at a greater value to the specialty fiber optic industry. Fujikura continues to lead with innovation and value in the quality solutions they develop. Put our SS-110 to the test by contacting us at 1-800-235-3423.

### Features

- RFID fiber holder identification and thermal stripping mode selection.
- Heating temperature, time, length, and pull speed are all adjustable.
- Heater height adjustable depending on fiber coating diameter.
- Standard blade sizes of common fiber types with custom options available.
- PC Software downloaded from SS-110

### Specifications

PARAMETER		VALUE
Applicable Fiber	Fiber Type	Silica Fiber
	Fiber Count	Single Fiber
	Cladding/Coating Diameter	Dictated by blade option selected. Standard offerings are 80/160 μm, 125/250 μm, 125/900 μm, 250/400 μm and 400/550 μm
Stripping Length		Max 35 mm in One Pass
Heating Time		1 to 60 seconds
Heating Temperature		60°C to 200°C
Stripping speed		Approx. 5 to 15 mm/sec
Fiber Holders		FH-110 series, FH-100 series, FH-70 series, FH-60 series
Physical	Width	Approx. 140 mm without protrusions
	Depth	Approx. 106 mm without protrusions
	Height	Approx. 103 mm without protrusions
	Weight	Approx. 900 g

*continued* →

## SS-110 Specialty Fiber Stripper

### Specifications (cont.)

PARAMETER		VALUE
Environmental Conditions	Temperature	Operate: 0°C to 40°C Storage: -40°C to 80°C
	Humidity	Operate: 0 to 95% RH non-condensing Storage: 0 to 95% RH non-condensing
AC Adapter	Input	AC 100 V to 240 V, 50/60 Hz, Max. 1.5 A
	Output	Approx. DC 19 V, Max 2.1 A
Connection Terminals	PC	USB 2.0 Mini Type-B
	Ground	Applicable by M3 truss screw
Wireless Communication	RFID	Compliant with ISO 15693
PC Software		Firmware update via internet
		Thermal stripping mode setup, upload, download and export

### Ordering Information

DESCRIPTION	AFL NO.
SS-110 Specialty Fiber Stripper with 125/250 Blades and One year factory warranty	S018251
80/160 µm Blades	S018252
125/250 µm Blades	S018253
125/900 µm Blades	S018254
250/400 µm Blades	S018255
400/550 µm Blades	S018256
Fiber Holder Adapter for FH-70 Series Fiber Holders	S018257
AC Adapter – ADC-21	S018168
AC Power Cord – ACC-09	S014390

### Fiber Holders

DESCRIPTION	AFL NO.
FH-110-60 Fiber Holder	S018215
FH-110-100 Fiber Holder	S018216
FH-110-125 Fiber Holder	S018217
FH-110-150 Fiber Holder	S018218
FH-110-180 Fiber Holder	S018219
FH-110-210 Fiber Holder	S018220
FH-110-250 Fiber Holder	S018221
FH-110-300 Fiber Holder	S018222
FH-110-350 Fiber Holder	S018223
FH-110-400 Fiber Holder	S018224
FH-110-500 Fiber Holder	S018225
FH-110-600 Fiber Holder	S018226
FH-110-700 Fiber Holder	S018227

DESCRIPTION	AFL NO.
FH-110-800 Fiber Holder	S018228
FH-110-900 Fiber Holder	S018229
FH-110-1000 Fiber Holder	S018230
FH-110-1100 Fiber Holder	S018231
FH-110-1200 Fiber Holder	S018232
FH-110-1300 Fiber Holder	S018233
FH-110-1400 Fiber Holder	S018234
FH-110-1500 Fiber Holder	S018235
FH-110-1600 Fiber Holder	S018236
FH-110-1700 Fiber Holder	S018237
FH-110-1800 Fiber Holder	S018238
FH-110-1900 Fiber Holder	S018239
FH-110-2000 Fiber Holder	S018240



## AFL PowerStrip®

AFL PowerStrip is a thermal stripper used in high strength splicing. Using the proven blade and centering design of the Schleuniger FiberStrip 7030 in addition to the fiber holder system, the AFL PowerStrip automatically centers the fiber, heats the buffer or coating and strips the buffer at a controlled rate with perfect alignment. The fiber holder system reduces fiber handling, making this tool ideal for any production environment.

### Features

- 250 µm and 900 µm fiber capability
- Short cycle time
- Lightweight and portable

### Specifications

PARAMETER	VALUE
Fibers Stripped - Single Buffered Fiber	Cladding diameter: 125 µm standard, 80 µm optional Coating diameter: 250 µm and 900 µm standard, 160 µm and 400 µm optional
Clamping System	Fujikura fiber holder clamp; compatible with FSM-45F/PM and 100 series fiber holders
Stripping Length	Up to 35 mm
Heater Temperature Range	110°C to 150°C (230°F to 302°F)
Heating Time	1.5 to 13 seconds
Cycle Time	Approximately 5 seconds/cycle (after heating)
Power Supply	Input: 100 to 240 V AC, 50/60 ± 3 Hz; Output: 12 V DC, 12 W, 1 A
Dimensions (L x W x D)	209 mm x 57 mm x 45 mm (8.25 x 2.25 x 1.8 inches)
Weight	0.7 kg (1.5 lbs)

### Ordering Information

DESCRIPTION	AFL NO.
<b>AFL PowerStrip Kit</b> Carrying case, fiber holder clamping system, blades and centralizers for 125/250 µm and 125/900 µm fiber, power supply 230 V AC or 100/120 V AC, power cord 2 m (6.5 feet), cleaning brush and tool set (hex keys, adjustment screwdriver)	S012808
<b>Coating Blades</b>	
80/125 µm	S014859
80/160 µm	S012656
125/250 µm	S012596
125/400 µm	S012628
125/500 µm	S014865
125/900 µm	S012604
204/360 µm	S014734
220/350 µm	S017002
230/500 µm	S014863
250/400 µm	S014400
250/900 µm	S014866
400/600 µm	S014719
420/550 µm	S018023
500/615 µm	S017003
600/800 µm	S014736
660/800 µm	S017086
1000/1400 µm	S014737

Blade Removal Tool	
PowerStrip Blade Removal Tool	S012704

Centralizers	
125 µm	S014860
160 µm	S012652
200 µm	S017889
250 µm	S012600
360 µm	S014738
400 µm	S012624
450 µm	S014739
500 µm	S014864
600 µm	S014718
680 µm	S017009
800 µm	S014740
900 µm	S012608
1400 µm	S014741

Power Supply	
12 V DC W/PLUG ADPT	S015185

\* Custom blades and centralizers available on request.



## High Tensile Stripper

The Fujikura high tensile stripper HTS-12 provides excellent strength performance when removing 250 µm and 400 µm buffer from optical fibers. Heating temperature and duration are fully adjustable for a variety of buffer materials. Self centering blades eliminate the need for an external guide and make replacement quick and easy. Designed for use with the FSM-40F/PM fiber holder system, the HTS-12 is an ideal solution for stripping when high strength fusion splices are a must.



### Specifications

PARAMETER	VALUE
Applicable Fiber:	
Cladding Diameter	125 µm (80 µm optional with 160 µm coating)
Coating Diameter	250 µm (160 µm / 400 µm optional)
Fiber Count	Single
Stripping Length	35 mm max
Temperature Settings	120°, 140°, 160°, or 180° C (adjustable)
Heating Time	3 seconds approximate
Applicable Fiber Holders	FH-40 & FH-100 series
Power Supply	100 to 240 VAC (50 to 60 Hz)
Dimensions (W x D x H)	140 x 60 x 60 (mm) / 5.51 x 2.36 x 2.36 (inches)
Weight	600 g / 1.3 lbs

### Ordering Information

DESCRIPTION	AFL NO.
HTS-12 High Tensile Stripper w/ 250 µm Blades and One year factory warranty	S012094
80/160 µm Blade for HTS-12	S016841
125/400 µm Blade for HTS-12	S011946
125/250 µm Blade for HTS-12	S011942
ADC-08 AC Adapter	S010996
ACC-09 AC Power Cord	S014390



## PCS-100 Polyimide Coating Stripper

Polyimide coated optical fiber are now widely used in the oil and gas and medical industries. The polyimide coating has superior heat and chemical resistance to conventional UV curable coating material, but the coating requires additional care to remove. Dangerous chemical stripping using hot sulfuric acid or burning the coating off are common methods to strip the fiber due to the thin coating and strong coating adhesion to the fiber cladding. AFL's PCS-100 Polyimide Fiber Coating Stripper is the first tool that uses a mechanical stripping method, providing a safe, consistent and quick stripping solution.

### Features

- Quick stripping** – A razorblade is applied to the fiber with specific tension and the coating is precisely planed along the fiber automatically. The process requires less time than the conventional methods of acid or heat. For a 125 µm fiber, 4 stripping passes at 90° rotational positions are typically required, and complete stripping is accomplished within 25 seconds. Larger fiber sizes require more stripping passes (at smaller rotational angle increments).
- Safe, high quality stripping** – Because hot acid is not used, the operation is much safer. In addition, the fiber quality degradation is kept at a minimum as the glass surface is not damaged by oxidization of the coating during burning or arcing.
- Flexible** – Many parameters, such as the razor blade position and stroke, and fiber rotation angle are all adjustable for various fiber sizes and coating materials.

### Specifications

STRIPPING PERFORMANCE	
Applicable Fiber	Silica based Single-mode and Multimode glass fiber
Fiber Count	Single
Applicable Coating	Polyimide coating and UV curable resin coating
Cladding Diameter Range	60 to 1200 µm
Coating Diameter Range	60 to 1,500 µm
Fiber Clamping	Adaptable to range of fiber/coating sizes by selection of applicable pair of FH-100-XXX series fiber holders
Strip Length	1 to 35 mm (Window stripping: 1 to 33 mm)
Stripping Time	4 stripping passes: 20 seconds
	8 stripping passes: 35 seconds
	12 stripping passes: 50 seconds
Blade Life	350 fibers / blade (In the case of 4 strips per fiber)
Stripping Modes	30 user-programmable modes
Proof Modes	30 user-programmable modes
PROOF TEST FUNCTION	
Maximum Proof Test Force	2 kgf
Typical Proof Test Cycle Time	3 seconds
DIMENSIONAL DATA	
Dimensions	230 mm (W) x 214 mm (D) x 151 mm (H)
Weight	5.0 kg excluding AC adapter
POWER SOURCE	
Power Input	AC100 to 240 V (50 Hz to 60 Hz)
OPERATION AND STORAGE CONDITIONS	
Operating Conditions	Temperature: 0 to 40°C, Humidity: 0 to 95% RH (Non-condensing)
Storage Conditions	Temperature: -40 to 80°C, Humidity: 0 to 95% RH (Non-condensing)

### Ordering Information

DESCRIPTION	AFL NO.
PCS-100 Polyimide Coating Stripper Includes: FH-100-150, ADC-15 AC Adapter, ACC-02, Instruction manual and PCB-01 replacement blades	S014973

### Accessories

DESCRIPTION	AFL NO.
FH-100-150	S014861
ADC-15	S014826
ACC-02	S001171
PCB-01 (Box of 50)	S015018



## APM-101 and APM-102 Automatic Preparation Machine

The APM-101 and APM-102 provide fiber optic preparation automation for assembly operations in a factory environment. Both perform all the operational steps required to strip, clean and cleave the fiber, automatically and with high repeatability. This includes stripping the fiber without degrading fiber quality, cleaning fiber with alcohol to remove coating residue, and cleaving consistently at a right angle to the fiber axis. The entire process is complete in as little as 21 seconds.

The APM-101 is designed to accept the FH-100-250 fiber holder that is a component of Fujikura's FSM-100 series and LZM-100 splicing platforms. It can also accept the FH-40/45-250 fiber holder used with the FSM-40/45F and FSM-40/45PM splicing platforms. The APM-102 is designed to accept the FH-70-250 fiber holder used with Fujikura models 70S, 19S and 12S.

### Features

- **Automatic cleaning** – main components in the machine are automatically cleaned allowing a continuous sequence of fiber preparation operations.
- **Automatic residue collector** – coating residue and glass scraps are collected in separate containers.
- **Alcohol circulation system** – alcohol for cleaning is circulated in a closed system enabling a lengthy refill-free operation.
- **Diamond blade** – a diamond blade is used for cleaving in the tension method cleaving process and provides consistent cleave quality.
- **Reliable stripping method** – contact of the stripping blade to the fiber is prevented using guides in conjunction with the blade, minimizing damage to fiber during the stripping process.
- **Production-friendly design** – provides ergonomic, smooth and simple operation.

### Specifications

PARAMETER	VALUE
Applicable fiber	Single-mode and Multimode glass fiber
Applicable cladding diameter	125 µm
Applicable coating	UV curable resin coating
Applicable coating diameter	250 µm
Fiber clamping for APM-101	FH-100-250 series or FH-70-250 fiber holder
Fiber clamping for APM-102	FH-70-250
Cleave length	3 to 10 mm
Cleave angle	Typical 0.5°
Operating time	Typical 23 seconds (in the case of 125 µm diameter fiber with 250 µm coating)
Daily maintenance	Typically every 150 cycles
Operation action	1 step (Press start button only)
Air pressure	4 bar
Operating Condition	0 to 40°C at 0 to 95% RH (non-dew)
Storage condition	-40 to 80°C at 0 to 95% RH (non-dew)
Dimensions	170W x 370D x 120 H (MM)
Weight	5.1 kg

### Ordering Information

DESCRIPTION	AFL NO.
APM-101 Automatic Preparation Machine (requires FH-100-250 or FH-70-250 Fiber Holders) Includes: ADC-15 AC Adapter, ACC-02 Power Cord, ALC-01 Alcohol Container and REG-01 Air Pressure Regulator	S014974
APM-102 Automatic Preparation Machine (requires FH-70-250 Fiber Holder) Includes: ADC-15 AC Adapter, ACC-02 Power Cord, ALC-01 Alcohol Container and REG-01 Air Pressure Regulator	S015904

### Optional Accessories

DESCRIPTION	AFL NO.
ADC-15 AC Adapter	S014826
ACC-02 AC Cord	S001171
CSB-250 Coating Strip Blade	S017348
CB-04A Cleaver Blade	S015030
ALC-01 Alcohol Container	S015026
REG-01 Air Pressure Regulator	S015028



Included Accessories

## USC-03 Ultrasonic Cleaner

The Fujikura ultrasonic cleaner model USC-03 provides a simple and cost effective method for cleaning optical fibers when high strength fusion splices are required. This ultrasonic cleaner readily accepts all FH-40-XXX, FH-50-XXX, FH-70-XXX and FH-100-XXX series fiber holders. The Universal Fiber Holder Adapter, available as an optional accessory, enables the use of FH-XXX series fiber holders.

The high frequency ultrasonic action cleans debris and coating residue without damaging the exposed cladding and a built-in timer ensures that the required cleaning time is consistently used for all fibers processed. This cleaner, when used in conjunction with high strength stripping and cleaving accessories, produces outstanding results for the most demanding high strength applications.

### Features

- Built-in timer assures correct cleaning time
- Adjustable high intensity vibratory cleaning action
- Adjustment knob allows fine-tuning of fiber submersion depth
- Alcohol bath lid prevents cleaning fluid evaporation when machine is idle

### Specifications

PARAMETER	VALUE
Applicable Fibers	Single optical fiber
Applicable Fiber Holders	FH-40, 50, 70 and 100 series
Recommended Fluid	≥99% Ethyl alcohol or Isopropyl alcohol
Tank Capacity	43 - 53 cm <sup>3</sup>
Ultrasonic Frequency	50 kHz
Fiber Cleaning Length	49 mm (max), adjustable
Output Power	3.0 W (max)
Timer Range	1 to 99 seconds
Power Requirement	AC 100 to 240 V / 50 Hz to 60 Hz
Operating Environment	0°C to 40°C, 0 to 95% RH, non-condensing
Storage Environment	-20°C to 60°C, non-condensing humidity
Dimensions (W x D x H)	95 x 190 x 162 (mm) / 3.74 x 7.48 x 6.38 (inches)
Weight	1 kg / 2.2 lbs

### Ordering Information

DESCRIPTION	AFL NO.
USC-03	S014783
Universal Fiber Holder Adapter	S013568
ADC-10 Power Adapter	S012548
ACC-09 Power Cord	S014390

**Please Contact your AFL Sales Rep for information about any of our other products or services.**

**TEST & INSPECTION**



FOCIS Lightning<sup>®</sup>2, FOCIS WiFi2 and FOCIS Flex Fiber Optic Connector Inspection Systems



FlexScan<sup>®</sup> OTDR



OPM5 Optical Power Meter and OLS4 Light Source

**FIBER INSIDE PLANT**

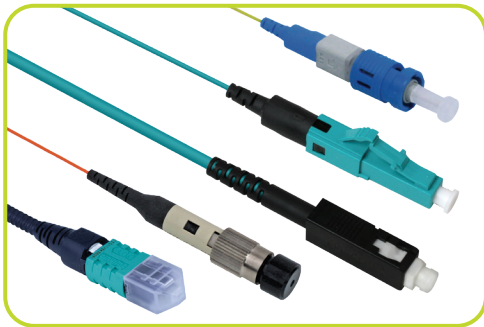

FUSEConnect<sup>®</sup>  
MPO, FC, SC, LC and ST Connectors

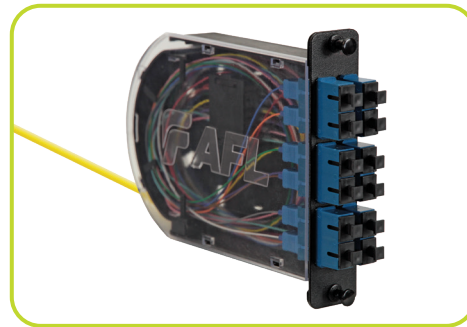

Poli-MOD<sup>®</sup>  
Patch and Splice Module





