

F AFL

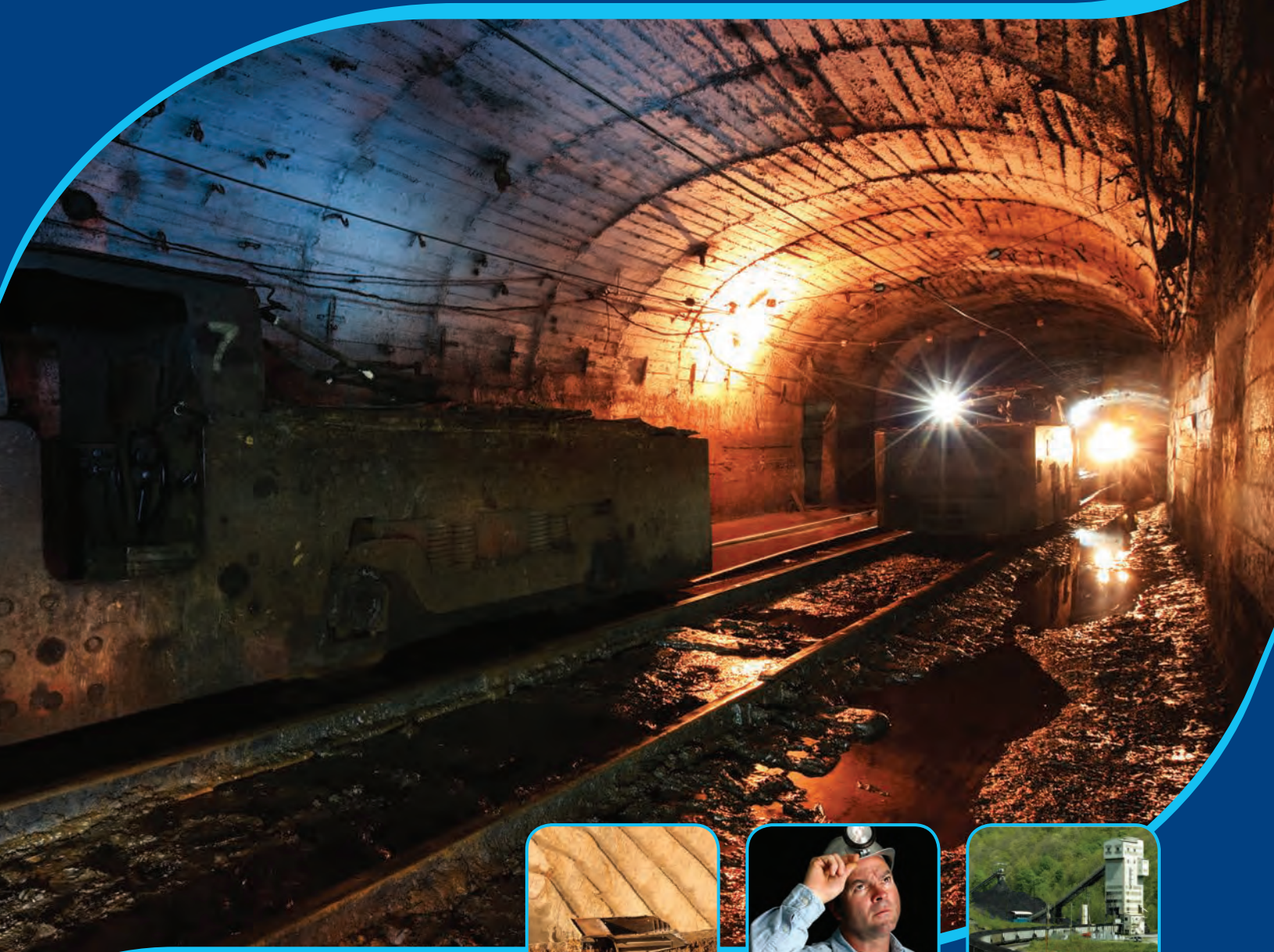

**FIBER OPTIC PRODUCTS
FOR THE MINING INDUSTRY**

Founded in 1984, AFL is an international manufacturer providing end-to-end solutions to the energy, service provider, enterprise and industrial markets as well as several emerging markets.

AFL's products are in use in over 130 countries and include fiber optic cable and hardware, transmission and substation accessories, outside plant equipment, connectivity, test and inspection equipment, fusion splicers and training.

AFL also offers a wide variety of services supporting data center, enterprise, wireless and outside plant applications.

AFL is dedicated to bringing our customers a quality product as well as delivering superior value.



Table of Contents

Fiber Optic Cable

Premise Cable

Breakout Cable	3
Indoor/Outdoor Riser Tight Buffered Cable	5
Indoor/Outdoor Multi-unit Riser Tight Buffered Cable	7
Armored Tight Buffered Circular Premise Cable	9
Copper/Fiber Composite Cable	11

Tactical Cable

Tactical Tight Buffered Cable	13
---	----

Optical Ground Wire (OPGW)

AlumaCore OPGW	15
CentraCore OPGW	17
HexaCore OPGW	19

All-Dielectric Self Supporting Cable (AFL-ADSS®)

Mini-Span® ADSS Cable	21
All-Dielectric Self-Supporting (AFL-ADSS®) Fiber Optic Cable	26
SkyWrap®	43

All-Dielectric Self Supporting Cable Accessories

Mini-Bracket	45
Mini Formed Wire Tangent Support (FTS)	45
Mini-Dead Ends	46
Trunnion Assemblies—Single and Double Cables	47
Wedge Dead End	49
AVD Series Spiral Vibration Dampers	51
SVD Series Spiral Vibration Dampers	53

Loose Tube Cable

All-Dielectric Armored Rodent-Resistant OSP Loose Tube (LN Series)	55
Riser Single-Jacket Non-Armored I/O Loose Tube (LV Series SJ)	57

Fiber Management

Rack Mount Panels

LS Series 1RU Fiber Termination Patch/Splice Panel	59
LS Series 2RU Fiber Termination Patch/Splice Panel	61
LS Series 4RU Fiber Termination Patch Panel	63
Xpress Fiber Management® (XFM®) 4RU Patch Panel	65

Indoor Splicing and Distribution Enclosures

LightLink 500 Optical Splicing and Distribution Enclosure	66
---	----

Fiber Demarcation

OptiNID® Duo Optical Demarcation Enclosure	67
OptiNID® 760XL Optical Demarcation Closure	69
OptiNID® 500 Optical Demarcation Closure	70
OptiNID® Optical Demarcation Accessories	71

Panel Accessories

LightLink Adapter Plates	73
Pigtail Assemblies for Patch and Splice Panels	76

Optical Interconnect Modules

Poli-MOD® Patch and Splice Module	77
---	----

Fiber Optic Connectors and Components

Field Master® Field-Installable Connectors	79
Field Master Tool Kit	80
Crimp Tool for Field Master Connectors	80
FASTConnect® Field-Installable Connectors	81
FUSEConnect® Field-Installable Connectors	83
FUSEConnect Tool Kit and Accessories	85
Optical Terminators	86
Fanout Kits	87

Fiber Optic Cable Assemblies

Duplex Cable Assemblies	88
Multi-Fiber Cable Assemblies	89

Splice Closures and Accessories

Sealed Fiber Optic Splice Closures	91
Apex® X-2 Sealed Splice Closure NEW	92
Apex X-2S Sealed Splice Closure NEW	98
LightGuard® (LG) Peel & Seal Grommet Systems for Sealed Closures	104
LG-55 Sealed Fiber Optic Splice Closure	105
LG-55-SC Sealed Fiber Optic Splice Closure	106
LG-150 Sealed Fiber Optic Splice Closure	107
LG-250 Sealed Fiber Optic Splice Closure	109
LG-350 Sealed Fiber Optic Splice Closure	112
LG-350-AC Drop Access Sealed Fiber Optic Splice Closure	114
LG-350XL Sealed Fiber Optic Splice Closure	116
LG-Sealed Splice Closure Accessories	118
LG-Aerial Weathertight Fiber Optic Splice Closures	121
LG-410 Aerial Weathertight Fiber Optic Splice Closure	122
LG-420 Aerial Weathertight Fiber Optic Splice Closure	124
LG-420 FTTx Aerial Weathertight Closure	126

Table of Contents (cont.)

Splice Closures and Accessories (cont.)

LG-500 Aerial Weathertight Fiber Optic Splice Closure 128
 LG-500 FTTx Aerial Weathertight Closure 130
 LG-600 Aerial Weathertight Fiber Optic Splice Closure 132
 LG-600 FTTx Aerial Weathertight Closure 134
 LG Aerial Splice Closure Accessories 136

Splice Closure Accessories

Interchangeable Grommets for Splice Closures & Fiber Enclosures. . . 138
 LightLink Fiber Optic Splice Trays. 140
 Fiber Storage Units. 148
 Fiber Storage Units for ADSS Fiber Optic Cable. 149

Fusion Splicers and Accessories

Fujikura 90S+ Fusion Splicer **NEW** 150
 Fujikura 41S+ Fusion Splicer **NEW** 153
 Portable Tripod Workstation 156
 ASW-02 Splicing Workstation 157
 CT08 Fiber Cleaver. 158
 CT50 Fiber Cleaver. 160
 Splice Protection Sleeves 162

Fiber Optic Test and Inspection Equipment

OTDRs and Accessories

FlexScan® FS300 Quad OTDR **NEW** 164
 FlexScan® FS200 Single-mode OTDR 171
 OTDR Fiber Rings 177

Optical Power Meters

OPM5 and OPM4 Optical Power Meters 181

Fiber Optic Loss Test Kits

Optical Loss Test Kits 185

Visual Fault Identifiers

VFI4 Visual Fault Identifier **NEW** 189

Fiber Optic Connector Inspection

FOCIS Lightning® Multi-Fiber Optic Connector Inspection System . . . 191
 OFS300 Optical Microscope 195

Fiber Identifiers

OFI-BIPM and OFI-BIPMe Optical Fiber Identifiers **NEW** 197

Cleaning Accessories

One-Click® Cleaners. 200
 NEOCLEAN Cleaners 202
 Cletop Optical Fiber Connector Cleaner. 203
 Cleaning Fluids and Wipes 204
 FCC2 Enhanced Fiber Connector Cleaner and Preparation Fluid 204
 Debris Destroyer® Fiber Cleaning Pen 205
 Optical Cloth Wipes 206
 Cleaning Kits 207



Breakout Cable

Breakout cables combine multiple fiber flexibility with the strength of individually jacketed fibers. Breakout cables from AFL can be terminated for fanout assemblies. Breakout cable is available in counts of 2-24 fibers.

Features

- Fiber count 2-24
- Sub-units printed every 6 inches
- Tight buffer and sub-unit jacket are available in a variety of colors

Applications

- Rugged multi-fiber cross-connects
- Intrabuilding "backbone"
- Fiber "backbone" to communications closet

Cable Components

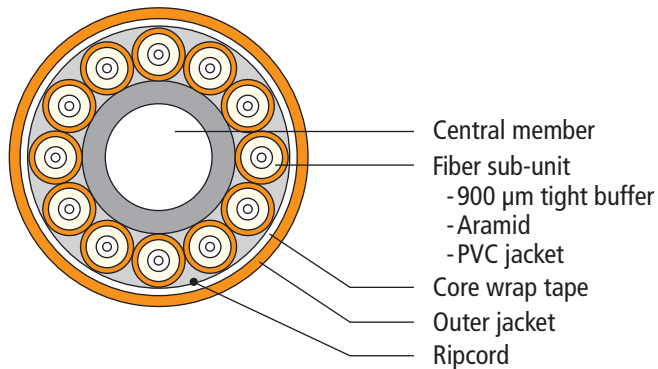

Fiber Specifications

CORE SIZE/FIBER TYPE	ISO/IEC	MAXIMUM ATTENUATION (DB/KM)			OVERFILL LAUNCH MIN. BANDWIDTH (MHZ•KM)		EMB _c (MHZ•KM)	GIGABIT ETHERNET MIN. LINK DISTANCE (METERS)		10 GIGABIT ETHERNET MIN. LINK DISTANCE (METERS)	
		850 NM	1300 NM	1550 NM	850 NM	1300 NM		850 NM	1300 NM	850 NM	1300 NM
(6) 62.5 Giga-Link™ 300	OM1	3.5	1.2	N/A	200	600	N/A	300	550	32	—
(5) 50 Giga-Link™ 600	OM2	3.5	1.5	N/A	500	500	N/A	600	600	82	—
(L) 50 Laser-Link 300	OM3	3.0	1.2	N/A	1,500	500	2,000	1,000	550	300	—
(C) 50 Laser-Link 550	OM4	3.0	1.2	N/A	3,500	500	4,700	1,040	550	550	—
(W) AFL Wideband Multimode	OM5	3.0	1.2	N/A	3,500	500	4,700	1,040	550	550	—
(9) Single-mode (ITU G.652.D/G.657.A1)	OS2	N/A	0.5	0.5	N/A	N/A	N/A	N/A	5,000	N/A	10,000



Breakout Cable

Mechanical Data

CABLE TYPE	AFL NO.	FIBER COUNT	NOMINAL DIAMETER INCHES (MM)	WEIGHT LBS/1000FT (KG/KM)	TENSION		BENDING RADIUS	
					LBS (N)		INCHES (CM)	
					INSTALLATION	LONG TERM	INSTALLATION	LONG TERM
Riser Breakout Cable	BR004★241##1	4	0.33 (8.5)	44 (65)	150 (660)	45 (198)	5.1 (12.8)	3.4 (8.5)
	BR006★241##1	6	0.40 (10.1)	64 (95)	150 (660)	45 (198)	6.0 (15.2)	4.0 (10.1)
	BR008★241##1	8	0.46 (11.6)	84 (125)	150 (660)	45 (198)	6.9 (17.4)	4.6 (11.6)
	BR012★241##1	12	0.58 (14.7)	138 (205)	150 (660)	45 (198)	8.7 (22.1)	5.8 (14.7)
	BR024★241##1	24	0.65 (16.6)	118 (175)	300 (1320)	90 (396)	11.4 (29.0)	7.6 (19.3)
Plenum Breakout Cable	BP004★301##1	4	0.36 (9.0)	57 (85)	100 (440)	30 (132)	5.3 (13.5)	3.6 (9.0)
	BP006★301##1	6	0.42 (10.6)	79 (118)	100 (440)	30 (132)	6.3 (15.9)	4.2 (10.6)
	BP008★301##1	8	0.48 (12.2)	105 (156)	100 (440)	30 (132)	7.2 (18.3)	4.8 (12.2)
	BP012★301##1	12	0.61 (15.5)	169 (252)	100 (440)	30 (132)	9.2 (23.2)	6.1 (15.5)

★ Fiber Types – please specify fiber type with number in the Fiber Specifications table on previous page.

Outer Jacket/Sub-unit Color – please specify outer jacket/sub-unit color when ordering (see below)

Cable Jacket Color Options

1 - Blue	7 - Red
2 - Orange	8 - Black
3 - Green	9 - Yellow
4 - Brown	A - Violet
5 - Slate	B - Rose
6 - White	C - Aqua

Qualifications

GOVERNING BODY	STANDARD CODE
MSHA	
NFPA	
RoHS	2002/95/EC
EIA/TIA	568-A
ICEA	
ISO	
ITU	
Telcordia	GR-409-CORE

Temperature Specifications

TEMPERATURE RANGE	
INSTALLATION	0°C to +70°C
OPERATING	0°C to +70°C
STORAGE	-40°C to +75°C

Contact AFL for further details.

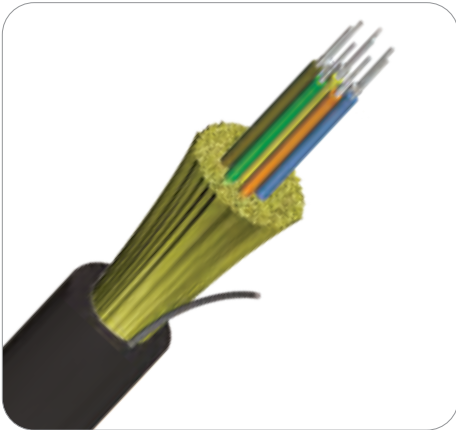

Indoor/Outdoor Riser Tight Buffered Cable

Indoor/Outdoor Tight Buffered cables are specified for campus network cabling between buildings where interbuilding lengths are short enough that the installer can recognize savings from the lower costs of terminating tight buffered cables.

For indoor applications the cable is OFNR listed. For outdoor applications the cable is manufactured with an outer jacket that incorporates a UV stabilizer for protection against exposure to the sun plus an anti-fungus protection for use in underground applications.

Features

- Available with 2 to 24 fibers
- 12-fiber water-blocked sub-units
- Moisture-resistant, fungus-resistant and UV-resistant outer jacket

Applications

- ONFR inside plant and outside plant environments
- Campus LAN
- Building Interconnections
- Mining

Cable Components

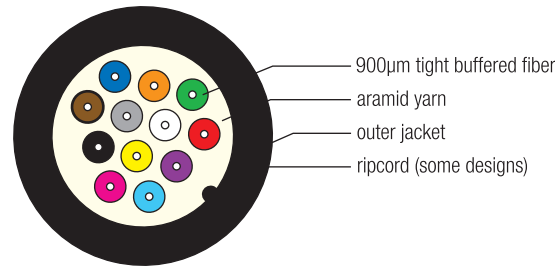

Fiber Specifications

CORE SIZE/FIBER TYPE	ISO/IEC	MAXIMUM ATTENUATION (DB/KM)			OVERFILL LAUNCH MIN. BANDWIDTH (MHZ•KM)		EMB _C (MHZ•KM)	GIGABIT ETHERNET MIN. LINK DISTANCE (METERS)		10 GIGABIT ETHERNET MIN. LINK DISTANCE (METERS)	
		850 NM	1300 NM	1550 NM	850 NM	1300 NM		850 NM	1300 NM	850 NM	1300 NM
(6) 62.5 Giga-Link™ 300	OM1	3.5	1.2	N/A	200	600	N/A	300	550	32	—
(5) 50 Giga-Link™ 600	OM2	3.5	1.5	N/A	500	500	N/A	600	600	82	—
(L) 50 Laser-Link 300	OM3	3.0	1.2	N/A	1,500	500	2,000	1,000	550	300	—
(C) 50 Laser-Link 550	OM4	3.0	1.2	N/A	3,500	500	4,700	1,040	550	550	—
(W) AFL Wideband Multimode	OM5	3.0	1.2	N/A	3,500	500	4,700	1,040	550	550	—
(9) Single-mode (ITU G.652.D/G.657.A1)	OS2	N/A	0.5	0.5	N/A	N/A	N/A	N/A	5,000	N/A	10,000



STOCK ITEM

Indoor/Outdoor Riser Tight Buffered Cable

Mechanical Data

CABLE TYPE	AFL NO.	FIBER COUNT	NOMINAL DIAMETER	WEIGHT	TENSION		BENDING RADIUS	
					LBS (N)		INCHES (CM)	
					INSTALLATION	LONG TERM	INSTALLATION	LONG TERM
Indoor/Outdoor Tight Buffered Cable	KR002★481#01	2	0.19 (4.8)	14 (21)	150 (660)	45 (198)	2.8 (7.2)	1.9 (4.8)
	KR004★481#01	4	0.19 (4.8)	15 (23)	150 (660)	45 (198)	2.8 (7.2)	1.9 (4.8)
	KR006★531#01	6	0.21 (5.3)	19 (28)	150 (660)	45 (198)	3.1 (8.0)	2.1 (5.3)
	KR008★561#01	8	0.22 (5.6)	23 (33)	150 (660)	45 (198)	3.3 (8.4)	2.2 (5.6)
	KR012★651#01	12	0.26 (6.5)	26 (38)	150 (660)	45 (198)	3.5 (9.0)	2.6 (6.5)
	KR018★801#01	18	0.31 (8.0)	40 (59)	300 (1320)	90 (396)	4.7 (12.0)	3.1 (8.0)
	KR024★871#01	24	0.33 (8.7)	46 (69)	300 (1320)	90 (396)	5.2 (13.1)	3.4 (8.7)

★ Fiber Types – Replace asterisk (★) in AFL number with number in the Fiber Specifications table on previous page.

Outer Jacket Color – Replace hashtag (#) in AFL number with number in the Cable Jacket Color table below.

Cable Jacket Color* Options

1 - Blue	8 - Black
2 - Orange	9 - Yellow
3 - Green	A - Violet
4 - Brown	B - Rose
5 - Slate	C - Aqua
6 - White	K - Erika Violet (RAL 4003)
7 - Red	

* All jacket colors are UV stable and contain anti-fungal additive.
For best performance, AFL recommends Black Outer Jacket.

Qualifications

GOVERNING BODY	STANDARD CODE	COMPONENT
Telcordia	GR-20-CORE GR-409-CORE	Water-Blocked Cabled Buffer Tube Core Sub-units
EIA/TIA	598-A	Sub-units
ICEA	S-104-696	Sub-units
MSHA		
RoHS	2002/95/EC	Cable

Temperature Specifications

TEMPERATURE RANGE	
Installation	-20°C to +75°C
Operation	-40°C to +75°C
Storage	-40°C to +75°C

Contact AFL for further details.



Indoor/Outdoor Multi-unit Riser Tight Buffered Cable

AFL now offers high fiber count Indoor/Outdoor Riser Cables. Waterblocked 12-fiber sub-units are helically stranded to provide sub-unitized cables ranging from 24 to 72 fiber counts. These cables are OFNR listed for indoor applications. Both the sub-unit jackets and outer sheath contain a UV stabilizer and anti-fungus protection for use in outdoor applications. Sub-units contain a water-swellable aramid and 12 tight buffered fibers.

Features

- Available with 24 to 72 fibers
- 12-fiber water-blocked sub-units
- Moisture-resistant, fungus-resistant and UV-resistant sub-unit jackets and outer sheath

Applications

- ONFR inside plant and outside plant environments

Cable Components

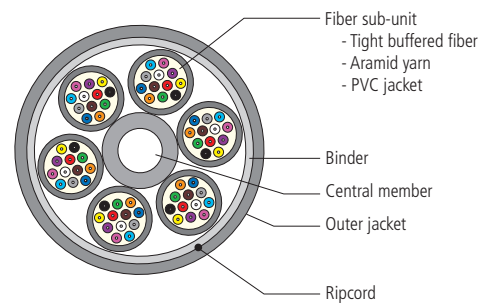

Fiber Specifications

CORE SIZE/FIBER TYPE	ISO/IEC	MAXIMUM ATTENUATION (DB/KM)			OVERFILL LAUNCH MIN. BANDWIDTH (MHZ•KM)		EMB _c (MHZ•KM)	GIGABIT ETHERNET MIN. LINK DISTANCE (METERS)		10 GIGABIT ETHERNET MIN. LINK DISTANCE (METERS)	
		850 NM	1300 NM	1550 NM	850 NM	1300 NM		850 NM	1300 NM	850 NM	1300 NM
(6) 62.5 Giga-Link™ 300	OM1	3.5	1.2	N/A	200	600	N/A	300	550	32	—
(5) 50 Giga-Link™ 600	OM2	3.5	1.5	N/A	500	500	N/A	600	600	82	—
(L) 50 Laser-Link 300	OM3	3	1.2	N/A	1,500	500	2,000	1,000	550	300	—
(C) 50 Laser-Link 550	OM4	3	1.2	N/A	3,500	500	4,700	1,040	550	550	—
(W) AFL Wideband Multimode	OM5	3	1.2	N/A	3,500	500	4,700	1,040	550	550	—
(9) Single-mode (ITU G.652.D/G.657.A1)	OS2	N/A	0.5	0.5	N/A	N/A	N/A	N/A	5,000	N/A	10,000



Indoor/Outdoor Multi-unit Riser Tight Buffered Cable

Mechanical Data

CABLE TYPE	AFL NO.	FIBER COUNT	NOMINAL DIAMETER	WEIGHT	TENSION		BENDING RADIUS	
			INCHES (MM)	LBS/1000 FT (KG/KM)	LBS (N)		INCHES (CM)	
	RISER				INSTALLATION	LONG TERM	INSTALLATION	LONG TERM
Indoor/Outdoor Tight Buffered Cable	KR024★611##1	24	0.67 (16.9)	169 (252)	300 (1320)	90 (396)	10.0 (25.3)	6.7 (16.9)
	KR036★611##1	36	0.67 (16.9)	178 (265)	300 (1320)	90 (396)	10.0 (25.3)	6.7 (16.9)
	KR048★611##1	48	0.67 (16.9)	187 (278)	300 (1320)	90 (396)	10.0 (25.3)	6.7 (16.9)
	KR060★611##1	60	0.76 (19.2)	197 (293)	300 (1320)	90 (396)	11.3 (28.8)	7.6 (19.2)
	KR072★611##1	72	0.81 (20.7)	233 (346)	300 (1320)	90 (396)	12.2 (31.0)	8.1 (20.7)

★ Fiber Types – Replace asterisk (★) in AFL number with number in the Fiber Specifications table on previous page.

Outer Jacket Color – Replace hashtag (#) in AFL number with number in the Cable Jacket Color table below.

Cable Jacket Color Options

1 - Blue	8 - Black
2 - Orange	9 - Yellow
3 - Green	A - Violet
4 - Brown	B - Rose
5 - Slate	C - Aqua
6 - White	K - Erika Violet (RAL 4003)
7 - Red	

Qualifications

GOVERNING BODY	STANDARD CODE	COMPONENT
Telcordia	GR-20-CORE GR-409-CORE	Water-Blocked Cabled Buffer Tube Core Sub-units
EIA/TIA	598-A	Sub-units
ICEA	S-104-696	Sub-units
RoHS	2002/95/EC	Cable

Temperature Specifications

TEMPERATURE RANGE	
Installation	-20°C to +75°C
Operation	-40°C to +75°C
Storage	-40°C to +75°C

Contact AFL for further details.

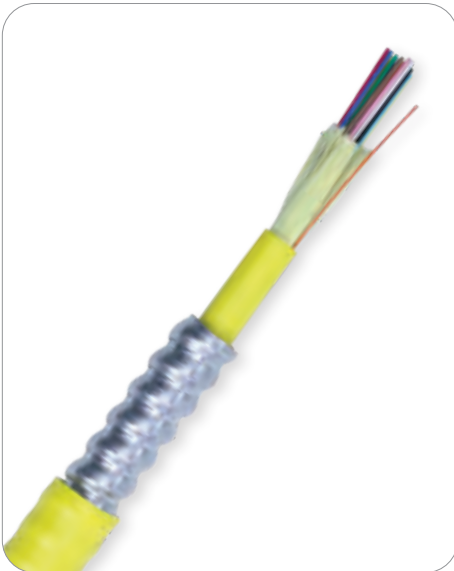

Armored Tight Buffered Circular Premise Cable

Armored Tight Buffered CPC Cables incorporate 4 to 144 fiber count CPC cables in a jacketed, aluminum interlocking armor. Jacketed aluminum interlocking armor provides the best balance of ruggedness, flexibility, and low weight. Flame rated armored cables with no outer jacket and flame rated armored cables with steel interlocking armor are also available. Interlocking armor can also be used with other types of trunk cables, including Indoor/Outdoor Distribution, Breakout and Premise MicroCore®.

Features

- Fiber counts 4-144
- Aluminum interlocking armor

Applications

- Routing inside of buildings where additional ruggedness is required or where increased rodent resistance is required
- Extra protection for fiber optic cables in harsh industrial environments
- Manufacturing plants
- High-density routings in data center applications

Cable Components

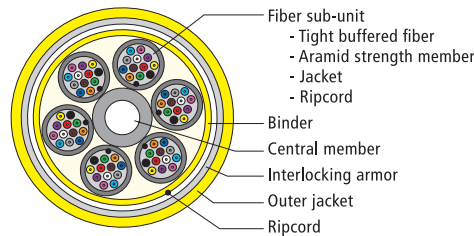

High Fiber Count Circular Premise Cable

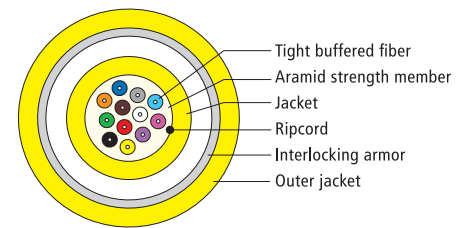

Circular Premise Cable

Fiber Specifications

CORE SIZE/FIBER TYPE	ISO/IEC	MAXIMUM ATTENUATION (DB/KM)			OVERFILL LAUNCH MIN. BANDWIDTH (MHZ•KM)		EMB _c (MHZ•KM)	GIGABIT ETHERNET MIN. LINK DISTANCE (METERS)		10 GIGABIT ETHERNET MIN. LINK DISTANCE (METERS)	
		850 NM	1300 NM	1550 NM	850 NM	1300 NM		850 NM	1300 NM	850 NM	1300 NM
(6) 62.5 Giga-Link™ 300	OM1	3.5	1.2	N/A	200	600	N/A	300	550	32	—
(5) 50 Giga-Link™ 600	OM2	3.5	1.5	N/A	500	500	N/A	600	600	82	—
(L) 50 Laser-Link 300	OM3	3.0	1.2	N/A	1,500	500	2,000	1,000	550	300	—
(C) 50 Laser-Link 550	OM4	3.0	1.2	N/A	3,500	500	4,700	1,040	550	550	—
(W) AFL Wideband Multimode	OM5	3.0	1.2	N/A	3,500	500	4,700	1,040	550	550	—
(9) Single-mode (ITU G.652.D/G.657.A1)	OS2	N/A	0.5	0.5	N/A	N/A	N/A	N/A	5,000	N/A	10,000



Armored Tight Buffered Circular Premise Cable

Mechanical Data

AFL NO.		FIBER COUNT	NOMINAL DIAMETER	WEIGHT		TENSION				BENDING RADIUS	
RISER	PLENUM			RISER	PLENUM	RISER		PLENUM		INSTALLATION	LONG TERM
				LBS/1000 FT (KG/KM)	LBS/1000 FT (KG/KM)	INSTALLATION	LONG TERM	INSTALLATION	LONG TERM		
			INCHES (MM)			LBS (N)	LBS (N)	LBS (N)	LBS (N)	INCHES (CM)	INCHES (CM)
UA004★481#01-AIAR	UP004★481#01-AIAP	4	0.46 (11.8)	79 (117)	89 (132)	150 (660)	45 (198)	100 (440)	30 (132)	7.0 (17.7)	5.0 (12.7)
CRO06★441#01-AIAR	CP006★441#01-AIAP	6	0.46 (11.8)	74 (109)	82 (122)	150 (660)	45 (198)	100 (440)	30 (132)	7.0 (17.7)	4.8 (12.2)
CRO12★551#01-AIAR	CP012★551#01-AIAP	12	0.51 (13.0)	79 (117)	89 (132)	150 (660)	45 (198)	100 (440)	30 (132)	7.0 (17.7)	5.0 (12.7)
CRO24★891#01-AIAR	CP024★841#01-AIAP	24	0.62 (15.7)	129 (193)	144 (215)	300 (1320)	90 (396)	150 (660)	45 (198)	9.3 (23.6)	5.3 (13.4)
CRO36★501##1-AIAR	CP036★551##1-AIAP	36	0.94 (24)	250 (370)	294 (439)	300 (1320)	90 (396)	150 (660)	45 (198)	14.2 (36.0)	9.4 (24.0)
CRO48★501##1-AIAR	CP048★551##1-AIAP	48	0.94 (24)	250 (370)	294 (439)	300 (1320)	90 (396)	150 (660)	45 (198)	14.2 (36.0)	9.4 (24.0)
CRO72★501##1-AIAR	CP072★551##1-AIAP	72	1.10 (27.9)	314 (465)	401 (597)	300 (1320)	90 (396)	150 (660)	45 (198)	16.5 (41.9)	11.0 (27.9)
CRO96★501##1-AIAR	CP096★551##1-AIAP	96	1.21 (30.7)	460 (680)	507 (755)	300 (1320)	90 (396)	150 (660)	45 (198)	18.1 (46.1)	12.1 (30.7)
CR144★501##1-AIAR	CP144★551##1-AIAP	144	1.37 (34.8)	460 (680)	534 (796)	300 (1320)	90 (396)	150 (660)	45 (198)	19.8 (50.3)	13.2 (33.5)

★ Fiber Types – Replace asterisk (★) in AFL number with number in the Fiber Specifications table on previous page.

Outer Jacket Color – Replace hashtag (#) in AFL number with number in the Cable Jacket Color table below.

Cable Jacket Color Options

1 - Blue	8 - Black
2 - Orange	9 - Yellow
3 - Green	A - Violet
4 - Brown	B - Rose
5 - Slate	C - Aqua
6 - White	K - Erika Violet (RAL 4003)
7 - Red	

Qualifications

GOVERNING BODY	STANDARD CODE
MSHA	
NFPA	
RoHS	2002/95/EC
EIA/TIA	
ICEA	
ISO	
ITU	
Telcordia	GR-409-CORE

Temperature Specifications

	PLENUM	RISER
INSTALLATION	0°C to +70°C	-10°C to +70°C
OPERATING	0°C to +70°C	-10°C to +70°C
STORAGE	-40°C to +75°C	-40°C to +75°C

Contact AFL for further details.

Premise Cable



Copper/Fiber Composite Cable

Rugged easy to use composite cable consisting of flexible stranded Copper conductors and integrating communications links utilizing fiber optic technologies. The breakout design provides additional protection for both the copper and fiber channels by individually protecting each with insulated jackets and all-dielectric strength members. For applications requiring remote low-voltage power and high-speed communications, these designs provide an efficient single-installation option where space is of a premium and devices are not easily accessed.

Features

- Rugged Riser rated constructions
- Water-blocked fiber units and cable core
- Flexible, stranded Copper, max 6 conductors (12AWG, 14AWG, 16AWG and 18AWG options available)
- High-speed fiber optics

Applications

- Remote application of low-voltage power
- Security networks
- IP enable appliances
- Wireless Access Points

Cable Components

12 Fiber

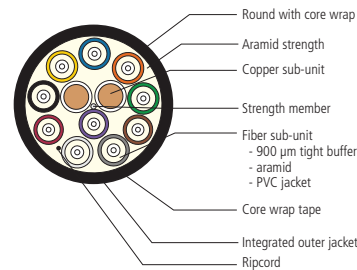

4 Fiber

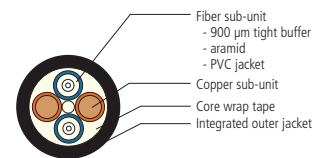

Fiber Specifications

CORE SIZE/FIBER TYPE	ISO/IEC	MAXIMUM ATTENUATION (dB/km)			OVERFILL LAUNCH MIN. BANDWIDTH (MHz•km)		EMBC (MHz•km)	GIGABIT ETHERNET MIN. LINK DISTANCE (meters)		10 GIGABIT ETHERNET MIN. LINK DISTANCE (meters)	
		850 nm	1300 nm	1550 nm	850 nm	1300 nm		850 nm	1300 nm	850 nm	1300 nm
(6) 62.5 Giga-Link™ 300	OM1	3.5	1.2	N/A	200	600	N/A	300	550	32	—
(5) 50 Giga-Link™ 600	OM2	3.5	1.5	N/A	500	500	N/A	600	600	82	—
(L) 50 Laser-Link 300	OM3	3.0	1.2	N/A	1,500	500	2,000	1,000	550	300	—
(C) 50 Laser-Link 550	OM4	3.0	1.2	N/A	3,500	500	4,700	1,040	550	550	—
(W) AFL Wideband Multimode	OM5	3.0	1.2	N/A	3,500	500	4,700	1,040	550	550	—
(9) Single-mode (ITU G.652.D/G.657.A1)	OS2	N/A	0.5	0.5	N/A	N/A	N/A	N/A	5,000	N/A	10,000

Qualifications

GOVERNING BODY	STANDARD CODE
Telcordia	GR-409-CORE
IECA	S-104-696
UL	13, 1666 rated, CL2R-OF Classified
MSHA	Approved
NEC	725 Classified

Temperature Specifications

TEMPERATURE RANGE	
INSTALLATION	-20°C to +70°C
OPERATING	-40°C to +70°C
STORAGE	-40°C to +70°C



Copper/Fiber Composite Cable

Mechanical Data

NO. OF POSITIONS	NO. OF FIBERS	NO. OF CONDUCTORS	CONDUCTOR SIZE	FIBER SUB-UNIT SIZE (mm)	AFL NO.	NOMINAL DIAMETER		WEIGHT	TENSION lbs (N)		BENDING RADIUS inches (cm)	
						Inches (mm)	lbs/1000 ft (kg/km)		INSTALL.	LONG TERM	INSTALL.	LONG TERM
4	2	2	18	2.0	BR002*2018X1-2CU18	0.35 (8.8)	50 (75)	300 (1334)	90 (400)	5.2 (13.2)	3.5 (8.8)	
			16	2.4	BR002*2418X1-2CU16	0.37 (9.4)	61 (91)			5.6 (14.1)	3.7 (9.4)	
			14	3.0	BR002*3018X1-2CU14	0.41 (10.5)	77 (115)			6.2 (15.8)	4.1 (10.5)	
			12	3.0	BR002*3018X1-2CU12	0.46 (11.6)	110 (160)			6.9 (17.4)	4.6 (11.6)	
6	2	4	18	2.0	BR002*2018X1-4CU18	0.39 (9.9)	78 (116)	300 (1334)	90 (400)	5.8 (14.9)	3.9 (9.9)	
			16	2.4	BR002*2418X1-4CU16	0.42 (10.7)	94 (140)			6.3 (16.1)	4.2 (10.7)	
			14	3.0	BR002*3018X1-4CU14	0.46 (11.7)	114 (170)			6.9 (17.6)	4.6 (11.7)	
			12	3.0	BR002*3018X1-4CU12	0.50 (12.6)	146 (218)			7.4 (18.9)	5.0 (12.6)	
6	3	3	18	2.0	BR003*2018X1-3CU18	0.39 (9.9)	71 (106)	300 (1334)	90 (400)	5.8 (14.9)	3.9 (9.9)	
			16	2.4	BR003*2418X1-3CU16	0.42 (10.7)	83 (124)			6.3 (16.1)	4.2 (10.7)	
			14	3.0	BR003*3018X1-3CU14	0.46 (11.7)	98 (146)			6.9 (17.6)	4.6 (11.7)	
			12	3.0	BR003*3018X1-3CU12	0.50 (12.6)	122 (182)			7.4 (18.9)	5.0 (12.6)	
6	4	2	18	2.0	BR004*2018X1-2CU18	0.39 (9.9)	64 (95)	300 (1334)	90 (400)	5.8 (14.9)	3.9 (9.9)	
			16	2.4	BR004*2418X1-2CU16	0.42 (10.7)	72 (107)			6.3 (16.1)	4.2 (10.7)	
			14	3.0	BR004*3018X1-2CU14	0.46 (11.7)	82 (122)			6.9 (17.6)	4.6 (11.7)	
			12	3.0	BR004*3018X1-2CU12	0.50 (12.6)	98 (146)			7.4 (18.9)	5.0 (12.6)	
8	2	6	18	2.0	BR002*2018X1-6CU18	0.49 (12.4)	94 (140)	300 (1334)	90 (400)	7.3 (18.6)	4.9 (12.4)	
			16	2.4	BR002*2418X1-6CU16	0.47 (11.9)	105 (150)			7.0 (17.9)	4.7 (11.9)	
			14	3.0	BR002*3018X1-6CU14	0.61 (15.6)	175 (255)			9.2 (23.4)	6.1 (15.6)	
			12	3.0	BR002*3018X1-6CU12	0.58 (14.7)	223 (332)			8.7 (22.1)	5.8 (14.7)	
8	4	4	18	2.0	BR004*2018X1-4CU18	0.49 (12.4)	80 (119)	300 (1334)	90 (400)	7.3 (18.6)	4.9 (12.4)	
			16	2.4	BR004*2418X1-4CU16	0.47 (11.9)	83 (124)			7.0 (17.9)	4.7 (11.9)	
			14	3.0	BR004*3018X1-4CU14	0.61 (15.6)	143 (213)			9.2 (23.4)	6.1 (15.6)	
			12	3.0	BR004*3018X1-4CU12	0.58 (14.7)	175 (261)			8.7 (22.1)	5.8 (14.7)	
8	6	2	18	2.0	BR006*2018X1-2CU18	0.49 (12.4)	66 (98)	300 (1334)	90 (400)	7.3 (18.6)	4.9 (12.4)	
			16	2.4	BR006*2418X1-2CU16	0.47 (11.9)	61 (91)			7.0 (17.9)	4.7 (11.9)	
			14	3.0	BR006*3018X1-2CU14	0.61 (15.6)	111 (165)			9.2 (23.4)	6.1 (15.6)	
			12	3.0	BR006*3018X1-2CU12	0.58 (14.7)	127 (189)			8.7 (22.1)	5.8 (14.7)	
12	6	6	18	2.0	BR006*2018X1-6CU18	0.57 (14.4)	105 (150)	300 (1334)	90 (400)	8.5 (21.6)	5.7 (14.4)	
			16	2.4	BR006*2418X1-6CU16	0.55 (13.9)	142 (211)			8.2 (20.9)	5.5 (13.9)	
			14	3.0	BR006*3018X1-6CU14	0.65 (16.5)	185 (275)			9.7 (24.8)	6.5 (16.5)	
			12	3.0	BR006*3018X1-6CU12	0.61 (15.4)	230 (335)			9.1 (23.1)	6.1 (15.4)	
12	8	4	18	2.0	BR008*2018X1-4CU18	0.57 (14.4)	91 (136)	300 (1334)	90 (400)	8.5 (21.6)	5.7 (14.4)	
			16	2.4	BR008*2418X1-4CU16	0.55 (13.9)	120 (179)			8.2 (20.9)	5.5 (13.9)	
			14	3.0	BR008*3018X1-4CU14	0.65 (16.5)	153 (228)			9.7 (24.8)	6.5 (16.5)	
			12	3.0	BR008*3018X1-4CU12	0.61 (15.4)	182 (271)			9.1 (23.1)	6.1 (15.4)	
12	10	2	18	2.0	BR010*2018X1-2CU18	0.57 (14.4)	77 (115)	300 (1334)	90 (400)	8.5 (21.6)	5.7 (14.4)	
			16	2.4	BR010*2418X1-2CU16	0.55 (13.9)	98 (146)			8.2 (20.9)	5.5 (13.9)	
			14	3.0	BR010*3018X1-2CU14	0.65 (16.5)	121 (180)			9.7 (24.8)	6.5 (16.5)	
			12	3.0	BR010*3018X1-2CU12	0.61 (15.4)	134 (200)			9.1 (23.1)	6.1 (15.4)	

* Fiber Types – Replace asterisk (*) in AFL number with number in the Fiber Specifications table on previous page.
 AFL No. is specified with Black jacket and color coded sub-units. Other jacket colors available – please contact AFL for updated AFL No.

Contact AFL for further details.

Premise Cable

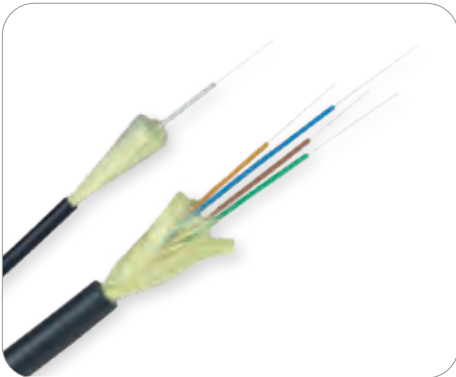

Tactical Tight Buffered Cable

AFL Tactical Tight Buffered Cables are ideal for use in installations where extreme environmental conditions are present. Designed to be deployed and retrieved in the field, AFL's Tactical Tight Buffered Cables are highly resistant to damage caused by repeated impacts crushing forces, abrasion and extreme temperatures.

Features

- Cut resistant polyurethane jacket with flame retardant options available
- Highly flexible construction allows for multiple deployments
- All aramid strength members
- Performance in wide temperature range
- UV, Fungus and water resistant
- High impact and crush resistance
- Durable in high traffic areas
- MIL-PRF-49291 qualified fiber available (-RH designation)

Applications

- Field deployment in abusive environments
- Temporary installation of critical communications lines where quick retrieval and re-use is necessary
- High Traffic areas
- Security and Sensing applications
- Broadcast deployments
- Installations in harsh environments

Cable Components

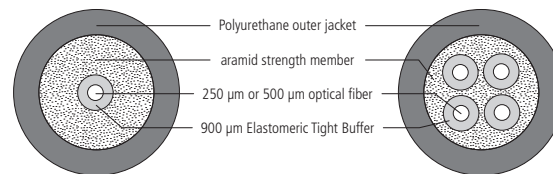

Specifications

CHARACTERISTIC	TEST PROCEDURE	PERFORMANCE
Tensile and elongation	EIA/TIA-455-33	
Operating tensile strength	EIA/TIA-455-33	
Low-temp flexibility	EIA/TIA-455-37	
Cyclic flexing	EIA/TIA-455-104	2000
Crush resistance	EIA/TIA-455-41	1800 N/cm or greater
Impact	EIA/TIA-455-25	200
Temperature cycling	EIA/TIA-455-3	-46°C to 85°C
Temperature/humidity cycling	EIA/TIA-455-5 Method B	
Life aging	EIA/TIA-455-4	
Freezing water immersion	EIA/TIA-455-98	

Tactical Tight Buffered Cable

Mechanical Data

AFL NO.	FIBER COUNT	NOMINAL DIAMETER		NOMINAL WEIGHT		MAXIMUM TENSILE LOAD		MINIMUM BEND RADIUS	
		INCHES	(MM)	LBS/1000FT	(KG/KM)	LBS (N)		INCHES (CM)	
						INSTALLATION	LONG TERM	INSTALLATION	LONG TERM
X%002*551#0H	2	0.22	(5.5)	16.2	(25)	400 (1780)	130 (578)	2.2 (5.5)	1.1 (2.8)
X%004*551#0H	4	0.22	(5.5)	16.2	(25)	400 (1780)	130 (578)	2.2 (5.5)	1.1 (2.8)
X%002*581#0H	2	0.23	(5.8)	21.5	(32)	400 (1780)	130 (578)	3.4 (8.7)	2.3 (5.8)
X%004*581#0H	4	0.23	(5.8)	21.5	(32)	400 (1780)	130 (578)	3.4 (8.7)	2.3 (5.8)
X%006*611#0H	6	0.24	(6.1)	22.2	(33)	400 (1780)	130 (578)	3.6 (9.2)	2.4 (6.1)
X%008*641#0H	8	0.25	(6.4)	28.8	(44)	470 (2090)	160 (712)	2.5 (6.4)	1.3 (3.2)
X%012*641#0H	12	0.25	(6.4)	30.8	(47)	470 (2090)	160 (712)	2.5 (6.4)	1.3 (3.2)

Note: Diameter and weight subject to change without notice

Note: For fiber counts other than those listed, please contact AFL

Replace percent (%) in AFL No. with corresponding jacket type below.

- 1 = Tactical Polyurethane
- 2 = Flame Retardant Polyurethane
- 3 = LSZH Polyurethane

500 µm primary coated fiber available, replace H in AFL number with number corresponding below.

- G = 500 µm Coated Optical Fiber
- H = 250 µm Coated Optical Fiber

Replace asterisk (*) in AFL No. with corresponding fiber type below.

- 5 = 50/125 µm multimode GIGA-Link™ 600
- 6 = 62.5/125 µm multimode GIGA-Link™ 300
- K = Bend Insensitive G.657A1 single-mode
- L = 50/125 µm OM3
- C = 50/125 µm OM4

Replace hashtag (#) in AFL No. with jacket color. See Tactical Cable Ordering Guide on page 17.

Customer specified print available.

See Tactical Cable Ordering Guide on page 17 for AFL No. designations.

Qualifications

GOVERNING BODY	STANDARD CODE	COMPONENT
EIA/TIA	EIA/TIA-455-33, EIA/TIA-455-37, EIA/TIA-455-104, EIA/TIA-455-41, EIA/TIA-455-25, EIA/TIA-455-3, EIA/TIA-455-5 Method B, EIA/TIA-455-4, EIA/TIA-455-98	Fiber Optic Cable
U.S. Department of Defense	MIL-PRF-49291 MIL-PRF-85045	Optical Fiber Fiber Optic Cable

Temperature Specifications

TEMPERATURE RANGE	
INSTALLATION	-46°C to +85°C
OPERATION	-46°C to +85°C
STORAGE	-55°C to +85°C

Contact AFL for further details.



AlumaCore OPGW

The AlumaCore Optical Ground Wire was AFL’s original OPGW design family dating back to 1984. OPGW provides all of the benefits of a traditional shield wire, such as providing short circuits a path to ground and protecting the circuits from lightning strikes, in addition to providing an optical pathway for communication.

Features

- Fiber counts up to 144
- Fiber bearing units similar to that of other fiber optic cable such as ADSS and underground cable
- Splicer familiarity and less splicing prep time required
- Aluminum pipe provides high crush resistance and good electrical performance
- Ability to be sectionalized

Applications

- Energy Market
- Transmission
- Right-of-Way
- Topmost part of the structure (shield wire position)

Cable Components

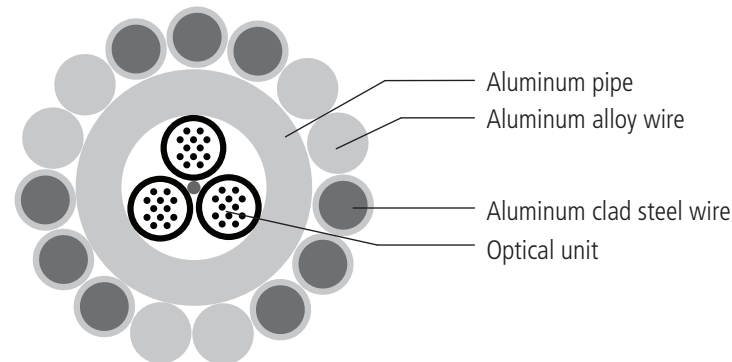

Typical Designs

FIBERS (MAX)	OPGW SIZE	FAULT CURRENT	TOTAL CONDUCTOR AREA		OVERALL DIAMETER		WEIGHT		APPROXIMATE RBS		SAG10 CHART #	MAX SHIP LENGTH (PER REEL TYPE)	
		(KA) ² SEC	IN ²	MM ²	IN	MM	LBS/FT	KG/M	LBS	KG		WOOD (M)	STEEL (M)
24	AC-64/528	68	0.1510	97.43	0.528	13.4	0.359	0.535	18,000	8,100	1-1450	6,700	7,000
24	AC-29/34/528	81	0.1510	97.43	0.528	13.4	0.281	0.418	12,000	5,440	1-1439	7,000	7,000
24	AC-74/552	81	0.1666	107.51	0.552	14.0	0.405	0.602	20,500	9,300	1-1453	6,000	7,000
24	AC-37/37/552	98	0.1666	107.51	0.552	14.0	0.306	0.455	13,000	6,000	1-1438	7,000	7,000
36	AC-71/571	95	0.1758	113.39	0.571	14.5	0.411	0.611	20,000	9,050	1-1461	5,900	7,000
36	AC-33/38/571	110	0.1758	113.39	0.571	14.5	0.323	0.478	13,250	6,000	1-1438	7,000	7,000
36	AC-86/607	118	0.2002	129.14	0.607	15.4	0.481	0.713	24,250	11,000	1-1457	5,000	6,900
36	AC-40/47/607	141	0.2002	129.14	0.607	15.4	0.375	0.558	16,000	7,250	1-1439	6,500	7,000
48	AC-86/646	151	0.2208	142.43	0.646	16.4	0.509	0.757	24,500	11,100	1-1461	4,700	6,600
48	AC-34/52/646	172	0.2208	142.43	0.646	16.4	0.417	0.621	17,250	7,800	1-1439	5,800	7,000
48	AC-129/724	239	0.2876	185.57	0.724	18.4	0.703	1.046	34,250	15,500	1-1453	3,400	4,700
48	AC-65/65/724	292	0.2876	185.57	0.724	18.4	0.530	0.789	21,900	9,900	1-1438	4,500	5,500

continued
→

AlumaCore OPGW

Typical Designs (cont.)

FIBERS (MAX)	OPGW SIZE	FAULT CURRENT (KA) ² SEC	TOTAL CONDUCTOR AREA		OVERALL DIAMETER		WEIGHT		APPROXIMATE RBS		SAG10 CHART #	MAX SHIP LENGTH (PER REEL TYPE)	
			IN ²	MM ²	IN	MM	LBS/FT	KG/M	LBS	KG		WOOD (M)	STEEL (M)
72	AC-88/659	154	0.2232	143.98	0.659	16.7	0.516	0.768	25,000	11,250	1-1461	4,700	6,500
72	AC-38/49/659	177	0.2232	143.98	0.659	16.7	0.414	0.615	17,000	7,750	1-1438	5,800	6,800
72	AC-102/691	182	0.2460	158.96	0.691	17.5	0.582	0.866	28,750	13,000	1-1450	4,100	5,700
72	AC-44/58/691	212	0.2460	158.96	0.691	17.5	0.465	0.692	19,900	9,000	1-1439	5,200	6,800
144	AC-82/646	144	0.2147	138.52	0.646	16.4	0.498	0.741	23,250	10,500	1-1461	4,800	6,500
144	AC-39/43/646	166	0.2147	138.52	0.646	16.4	0.395	0.588	15,500	7,000	1-355	6,100	6,500
144	AC-125/726	230	0.2813	181.48	0.726	18.4	0.6919	1.030	34,250	15,000	1-1453	3,500	4,800
144	AC-58/67/726	277	0.2813	181.48	0.726	18.4	0.5378	0.800	22,500	10,250	1-1439	4,500	6,100

This information denotes the input data needed for Sag10™ (sag and tension calculation) software. WIR files of all these catalog designs can be found on PLS-CADD web page.

NOTES:

Data contained in the table are approximations. Please reference the exact cable data sheet for the most up-to-date information.

The designs above are only a sampling of the options available from AFL. Contact customer service for a cable designed to your exact specifications.

Recommended Products for AlumaCore OPGW

DESCRIPTION	AFL NO.
Fiber Optic Cable Accessories	
OPGW Bolted Deadend	Refer to the Fiber Optic Cable Hardware catalog for specific AFL No.
OPGW Mechanical Suspension	Refer to the Fiber Optic Cable Hardware catalog for specific AFL No.
SB01 Splice Enclosure	Refer to the Fiber Optic Cable Hardware catalog for specific AFL No.
Motion Control	
Stockbridge Vibration Damper	Refer to the Transmission & Distribution catalog, Motion Control section , for specific AFL No.

Temperature Specifications

TEMPERATURE RANGE	
Operation	-40°C to +85°C
Storage	-50°C to +85°C
Installation	-30°C to +85°C

Qualifications

GOVERNING BODY	STANDARD CODE	COMPONENT
IEEE	1138	Cable
IEC	60794-4	Cable
TIA	598-D	Fiber
ASTM	B415	Alumium Clad Steel Wire (ACS wire)

Contact AFL for your customized OPGW solution.

Fiber Optic Cable



CentraCore OPGW

OPGW provides all of the benefits of a traditional shield wire, such as providing short circuits a path to ground and protecting the circuits from lightning strikes, in addition to providing an optical pathway for communication. The CentraCore design family can provide these features in a compact, light weight, high fiber density OPGW.

Features

- Fiber counts up to 96
- Light weight and compact yet robust design offering high fiber density
- Central stainless steel tube housing the fibers inserted into an aluminum pipe provides crush resistance and thermal protection for fibers

Applications

- Energy Market
- Transmission
- Right-of-Way
- Topmost part of the structure (shield wire position)

Cable Components

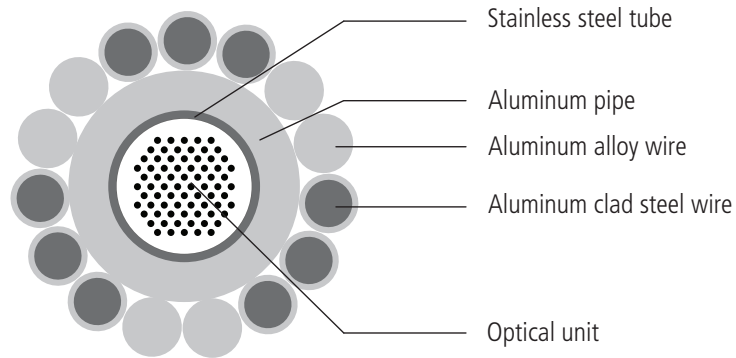

Typical Designs

FIBERS (MAX)	OPGW SIZE	FAULT CURRENT (KA) ² SEC	TOTAL CONDUCTOR AREA		OVERALL DIAMETER		WEIGHT		APPROXIMATE RBS		SAG10 CHART #	MAX SHIP LENGTH (PER REEL TYPE)	
			IN ²	MM ²	IN	MM	LBS/FT	KG/M	LBS	KG		WOOD (M)	STEEL (M)
48	CC-57/465	43	0.1248	80.52	0.465	11.80	0.314	0.467	16,250	7,400	1-1421	7000	7000
48	CC-29/29/465	54	0.1248	80.52	0.465	11.80	0.238	0.354	10,500	4,700	1-1455	7000	7000
48	CC-54/472	53	0.1334	86.09	0.472	12.00	0.316	0.470	15,750	7,100	1-1450	7000	7000
48	CC-27/27/472	63	0.1334	86.09	0.472	12.00	0.244	0.362	10,000	4,600	1-1438	7000	7000
48	CC-72/504	58	0.1482	95.64	0.504	12.80	0.382	0.568	20,500	9,300	1-1442	6350	7000
48	CC-32/40/504	73	0.1482	95.64	0.504	12.80	0.296	0.441	13,750	6,300	1-1440	7000	7000
48	CC-75/528	77	0.1663	107.28	0.528	13.40	0.411	0.612	21,500	9,700	1-1453	5950	7000
48	CC-38/38/528	96	0.1663	107.28	0.528	13.40	0.310	0.462	13,750	6,200	1-1439	7000	7000
72	CC-54/472	51	0.1318	85.01	0.472	12.00	0.316	0.470	15,750	7,100	1-1457	7000	7000
72	CC-27/27/472	61	0.1318	85.01	0.472	12.00	0.243	0.362	10,000	4,600	1-1438	7000	7000
72	CC-63/507	71	0.1547	99.80	0.507	12.90	0.367	0.546	18,250	8,300	1-1450	6650	7000
72	CC-32/32/507	85	0.1547	99.80	0.507	12.90	0.282	0.420	11,750	5,300	1-1438	7000	7000

CentraCore OPGW

Typical Designs (cont.)

FIBERS (MAX)	OPGW SIZE	FAULT CURRENT (KA) ² SEC	TOTAL CONDUCTOR AREA		OVERALL DIAMETER		WEIGHT		APPROXIMATE RBS		SAG10 CHART #	MAX SHIP LENGTH (PER REEL TYPE)	
			IN ²	MM ²	IN	MM	LBS/FT	KG/M	LBS	KG		WOOD (M)	STEEL (M)
72	CC-75/528	75	0.1646	106.20	0.528	13.40	0.410	0.611	21,500	9,700	1-1421	5950	7000
72	CC-38/38/528	94	0.1646	106.20	0.528	13.40	0.310	0.461	13,750	6,200	1-1455	7000	7000
96	CC-65/500	51	0.1393	89.86	0.500	12.70	0.385	0.573	18,900	8,600	1-1442	4800	4800
96	CC-30/36/500	64	0.1393	89.86	0.500	12.70	0.306	0.456	12,750	5,800	1-1440	4800	4800
96	CC-75/528	62	0.1550	100.00	0.528	13.40	0.431	0.641	21,500	9,800	1-1442	4800	4800
96	CC-38/38/528	81	0.1550	100.00	0.528	13.40	0.331	0.492	14,000	6,300	1-917	4800	4800
96	CC-86/563	86	0.1803	116.31	0.563	14.30	0.488	0.726	24,500	11,100	1-1425	4800	4800
96	CC-34/51/563	106	0.1803	116.31	0.563	14.30	0.340	0.591	17,400	7,900	1-1460	4800	4800

This information denotes the input data needed for Sag10™ (sag and tension calculation) software. WIR files of all these catalog designs can be found on PLS-CADD web page.

NOTES:

Data contained in the table are approximations. Please reference the exact cable data sheet for the most up-to-date information.

The designs above are only a sampling of the options available from AFL. Contact customer service for a cable designed to your exact specifications.

Recommended Products for CentraCore OPGW

DESCRIPTION	AFL NO.
Fiber Optic Cable Accessories	
OPGW Bolted Deadend	Refer to the Fiber Optic Cable Hardware catalog for specific AFL No.
OPGW Mechanical Suspension	Refer to the Fiber Optic Cable Hardware catalog for specific AFL No.
SBO1 Splice Enclosure	Refer to the Fiber Optic Cable Hardware catalog for specific AFL No.
Motion Control	
Stockbridge Vibration Damper	Refer to the Transmission & Distribution catalog, Motion Control section , for specific AFL No.

Temperature Specifications

TEMPERATURE RANGE	
Operation	-40°C to +85°C
Storage	-50°C to +85°C
Installation	-30°C to +85°C

Qualifications

GOVERNING BODY	STANDARD CODE	COMPONENT
IEEE	1138	Cable
IEC	60794-4	Cable
TIA	598-D	Fiber
ASTM	B415	Alumium Clad Steel Wire (ACS wire)

Contact AFL for your customized OPGW solution.

Fiber Optic Cable



HexaCore OPGW

Optical Ground Wire provides all of the benefits of a traditional shield wire, such as providing short circuits a path to ground and protecting the circuits from lightning strikes, in addition to providing an optical pathway for communication. The HexaCore, being that it is a multi-layer stranded design, is familiar in that it is similar to a conductor.

Features

- Fiber counts up to 432
- Capable of high environmental loading and long spans Anti-rotational device (ARD) typically not required for installation

Applications

- Energy Market
- Transmission
- Right-of-Way
- Topmost part of the structure (shield wire position)

Cable Components

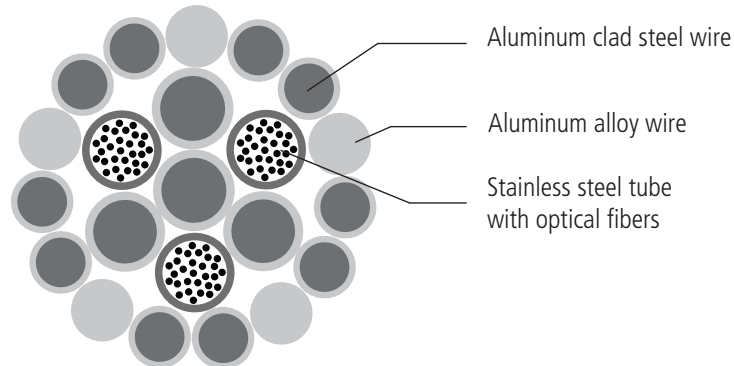

Typical Designs

FIBERS (MAX)	OPGW SIZE	FAULT CURRENT	TOTAL CONDUCTOR AREA		OVERALL DIAMETER		WEIGHT		APPROXIMATE RBS		SAG10 CHART #	MAX SHIP LENGTH (PER REEL TYPE)	
		(KA) ² SEC	IN ²	MM ²	IN	MM	LBS/FT	KG/M	LBS	KGF		WOOD (M)	STEEL (M)
24	SX-32/45/472	41	0.1235	79.67	0.472	12.0	0.281	0.418	14,750	6,700	1-1461	7000	7000
36	SX-41/32/472	41	0.1186	76.53	0.472	12.0	0.247	0.368	12,000	5,400	1-350	7000	7000
24	SX-75/37/555	96	0.1757	113.37	0.555	14.1	0.317	0.471	15,250	6,900	1-1438	7000	7000
24	SX-90/30/575	116	0.1889	121.86	0.575	14.6	0.313	0.466	14,250	6,400	1-430	7000	7000
96	S1-82/52/630	137	0.2131	137.45	0.630	16.0	0.417	0.621	20,000	9,000	1-1170	5800	7000
96	S1-83/59/647	152	0.2265	146.13	0.647	16.4	0.453	0.674	22,000	9,900	1-917	5300	7000
96	S1-91/61/668	177	0.2429	156.69	0.668	17.0	0.479	0.712	23,250	10,500	1-917	5100	6450
144	S1-71/52/630	118	0.2006	129.41	0.630	16.0	0.416	0.619	19,750	8,950	1-1440	5950	7000
144	S1-73/59/647	132	0.2140	138.09	0.647	16.4	0.452	0.673	21,750	9,800	1-350	5400	6850
144	S1-81/61/668	155	0.2304	148.65	0.668	17.0	0.472	0.702	23,000	10,400	1-1440	5150	6450

HexaCore OPGW

Typical Designs (cont.)

FIBERS (MAX)	OPGW SIZE	FAULT CURRENT (KA) ² SEC	TOTAL CONDUCTOR AREA		OVERALL DIAMETER		WEIGHT		APPROXIMATE RBS		SAG10 CHART #	MAX SHIP LENGTH (PER REEL TYPE)	
			IN ²	MM ²	IN	MM	LBS/FT	KG/M	LBS	KGF		WOOD (M)	STEEL (M)
288	S1-41/52/630	68	0.1632	105.28	0.630	16.0	0.414	0.616	19,000	8,600	1-1461	5890	7000
288	S1-42/59/647	79	0.1766	113.96	0.647	16.4	0.450	0.670	21,000	9,500	1-1461	5400	6850
288	S1-50/61/668	97	0.1930	124.52	0.668	17.0	0.476	0.708	22,250	10,000	1-1461	5125	6450

This information denotes the input data needed for Sag10™ (sag and tension calculation) software. WIR files of all these catalog designs can be found on PLS-CADD web page.

NOTES:

Data contained in the table are approximations. Please reference the exact cable data sheet for the most up-to-date information.

The designs above are only a sampling of the options available from AFL. Contact customer service for a cable designed to your exact specifications.

Recommended Products for HexaCore OPGW

DESCRIPTION	AFL NO.
Fiber Optic Cable Accessories	
OPGW Bolted Deadend	Refer to the Fiber Optic Cable Hardware catalog for specific AFL No.
OPGW Mechanical Suspension	Refer to the Fiber Optic Cable Hardware catalog for specific AFL No.
OG03 Opti-Guard Splice Enclosure	Refer to the Fiber Optic Cable Hardware catalog for specific AFL No.
Motion Control	
Stockbridge Vibration Damper	Refer to the Transmission & Distribution catalog, Motion Control section , for specific AFL No.

Temperature Specifications

TEMPERATURE RANGE	
Operation	-40°C to +85°C
Storage	-50°C to +85°C
Installation	-30°C to +85°C

Qualifications

GOVERNING BODY	STANDARD CODE	COMPONENT
IEEE	1138	Cable
IEC	60794-4	Cable
TIA	598-D	Fiber
ASTM	B415	Alumium Clad Steel Wire (ACS wire)

Contact AFL for your customized OPGW solution.

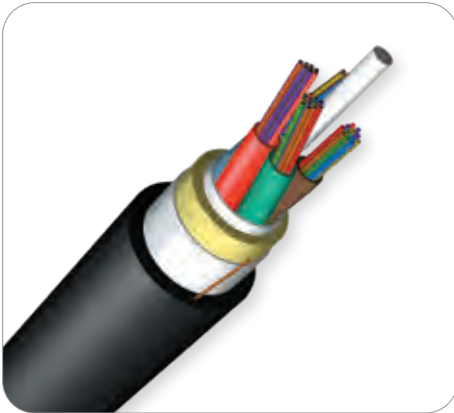

Mini-Span® ADSS Cable

AFL Mini-Span All-Dielectric Self-Supporting (ADSS) cable is designed for aerial distribution power lines. As its name indicates, there are no metallic components and the cable does not require a support or messenger wire. Mini-Span ADSS cables are a single jacket design intended for the shorter pole-to-pole span lengths in a distribution environment. The Mini-Span product families streamline aerial fiber optic hardware selection with various fiber counts in standardized diameters.

Features

- Gel-filled tubes are reverse-oscillated to allow slack for mid-span access
- Up to 144 fibers in cable
- Pole-to-pole span lengths range from 50 feet to over 1000 feet
- Single jacket design decreases the diameter and weight when compared to double jacket ADSS cable
- No separation requirement of ADSS from conductors per National Electric Safety Code (NESC) section 235

Applications

- Electric utility distribution power lines
 - Framed-in supply or communications space
- Underground duct
- Enterprise OSP networks
- Fiber-to-the-X networks

Typical Cable Components

4 Position 383

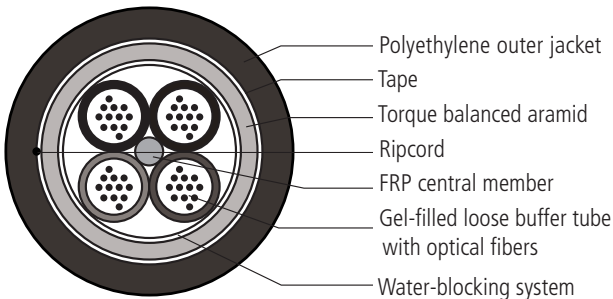

5 Position 424

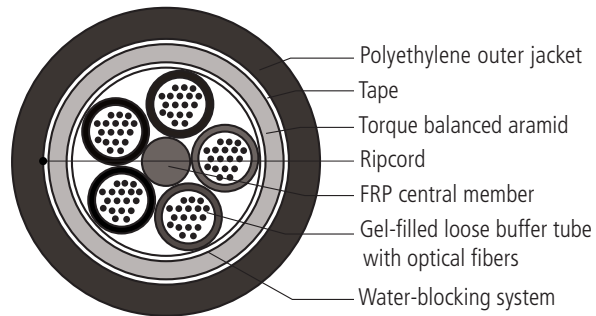

8 Position 535

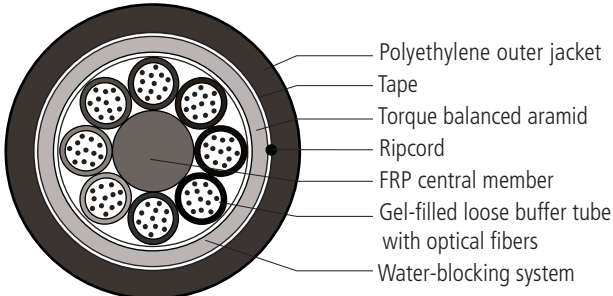

6 Position 535

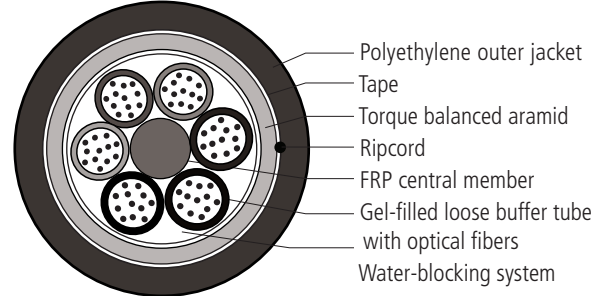

Installation Information

CABLE	NESC SPANS (@ 1.5% INITIAL SAG) FEET (METERS)			MAX. SAGGING TENSION		MAX. LOADING OPERATING TENSION		MIN. BENDING RADIUS (DYNAMIC)		MIN. BENDING RADIUS (STATIC)	
	LIGHT	MEDIUM	HEAVY	lbs	N	lbs	N	inches	cm	inches	cm
Mini-Span 383	450 (137)	300 (91)	180 (55)	183	814	402	1,785	8	20	6	15
Mini-Span 424	600 (183)	440 (134)	275 (84)	424	1886	707	3145	9	22	6.5	16.5
Mini-Span 535	1050 (320)	850 (259)	575 (175)	1,306	5,809	1,783	7,936	13	27	8	20.5

continued →

Mini-Span® ADSS Cable

Optical Information

CABLE	MAXIMUM ATTENUATION (db/km)			BANDWIDTH (MHz•km)		
	SINGLE-MODE (1310 nm/1550 nm)	MULTIMODE *62.5/125 µm (850 nm/1300 nm)	MULTIMODE 50/125 µm (850 nm/1300 nm)	SINGLE-MODE (1310 nm/1550 nm)	MULTIMODE *62.5/125 µm (850 nm/1300 nm)	MULTIMODE 50/125 µm (850 nm/1300 nm)
Mini-Span 383	0.35/0.25	3.5/1.2	2.9/0.9	n/a	200/600	500/500
Mini-Span 424						
Mini-Span 535						

* All 62.5/125 µm multimode ADSS cable transmission performances meet or exceed FDDI requirements. Premium transmission performance fibers available on request.

Mechanical Data

CABLE	FIBER COUNT	NOMINAL DIAMETER		NOMINAL WEIGHT		MAXIMUM LENGTHS*			
		inches	mm	lbs/1000' ft	kg/km	SINGLE-MODE		MULTIMODE	
						feet	meters	feet	meters
Mini-Span 383	2-48	0.383	9.7	49	72	32,800	10,000	26,250	8,000
Mini-Span 424	2-60	0.424	10.8	57	84	32,800	10,000	26,250	8,000
Mini-Span 535	2-144	0.535	13.6	100	148	32,800	10,000	26,250	8,000

* Longer lengths may be available upon request.

Recommended Products for ADSS Fiber Optic Cable

DESCRIPTION	AFL NO.
Fiber Optic Cable Accessories	
ADSS Mini Deadends	Refer to the ADSS Mini Deadends spec sheet for specific AFL No.
ADSS Formed Wire Deadends	Refer to the ADSS Formed Wire Deadends spec sheet for specific AFL No.
ADSS Suspension Unit	Refer to the ADSS Suspension Unit spec sheet for specific AFL No.
ADSS Trunnion Assemblies	Refer to the ADSS Trunnion Assemblies spec sheet for specific AFL No.
ADSS Temporary Grip	Refer to the ADSS Temporary Grip spec sheet for specific AFL No.
AGC Downlead Clamp for ADSS	Refer to the AGC Downlead Clamp for ADSS spec sheet for specific AFL No.
AVD Series Spiral Vibration Dampers	Refer to the AVD Series Spiral Vibration Dampers spec sheet for specific AFL No.
Coil Brackets	Refer to the Coil Brackets spec sheet for specific AFL No.

Temperature Specifications

TEMPERATURE RANGE	
Operation	-40°C to +70°C
Storage	-50°C to +70°C
Installation	-30°C to +70°C

Qualifications

GOVERNING BODY	STANDARD CODE	COMPONENT
IEEE	1222	Cable
TIA	598-D	Fiber

Contact AFL for your customized ADSS solution.

continued
→



Mini-Span® ADSS Cable

Ordering Information

CABLE	FIBER COUNT	FIBERS PER TUBE	NUMBER OF TUBES / FIBERS	AFL NO.		
				SINGLE-MODE	MULTIMODE 62.5/125	MULTIMODE 50/125
Mini-Span 383	6	6	1 w/6 (3 fillers)	AE0069C420AA0	AE0066C420AA0	AE0065C420AA0
	12	12	1 w/12 (3 fillers)	AE0129C420AA0	AE0126C420AA0	AE0125C420AA0
	18	12	1 w/12, 1 w/6 (2 fillers)	AE0189C420AA0	AE0186C420AA0	AE0185C420AA0
	24	12	2 w/12 (2 fillers)	AE0249C420AA0	AE0246C420AA0	AE0245C420AA0
	30	12	2 w/12, 1 w/6 (1 filler)	AE0309C420AA0	AE0306C420AA0	AE0305C420AA0
	36	12	3 w/12 (1 filler)	AE0369C420AA0	AE0366C420AA0	AE0365C420AA0
	48	12	4 w/12	AE0489C420AA0	AE0486C420AA0	AE0485C420AA0
Mini-Span 424	6	6	1 w/6 (4 fillers)	AE0069C520AA4	AE0066C520AA4	AE0065C520AA4
	12	12	1 w/12 (4 fillers)	AE0129C520AA4	AE0126C520AA4	AE0125C520AA4
	18	12	1 w/12, 1 w/6 (3 fillers)	AE0189C520AA4	AE0186C520AA4	AE0185C520AA4
	24	12	2 w/12 (3 fillers)	AE0249C520AA4	AE0246C520AA4	AE0245C520AA4
	30	12	2 w/12, 1 w/6 (2 fillers)	AE0309C520AA4	AE0306C520AA4	AE0305C520AA4
	36	12	3 w/12 (2 fillers)	AE0369C520AA4	AE0366C520AA4	AE0365C520AA4
	48	12	4 w/12 (1 filler)	AE0489C520AA4	AE0486C520AA4	AE0485C520AA4
Mini-Span 535	60	12	5 w/12 (no fillers)	AE0609C520AA4	AE0606C520AA4	AE0605C520AA4
	6	6	1 w/6 (7 fillers)	AE0069C820EA7	AE0066C820EA7	AE0065C820EA7
	12	12	1 w/12 (7 fillers)	AE0129C820EA7	AE0126C820EA7	AE0125C820EA7
	18	12	1 w/12, 1 w/6 (6 fillers)	AE0189C820EA7	AE0186C820EA7	AE0185C820EA7
	24	12	2 w/12 (6 fillers)	AE0249C820EA7	AE0246C820EA7	AE0245C820EA7
	30	12	2 w/12, 1 w/6 (5 fillers)	AE0309C820EA7	AE0306C820EA7	AE0305C820EA7
	36	12	3 w/12 (5 fillers)	AE0369C820EA7	AE0366C820EA7	AE0365C820EA7
	48	12	4 w/12 (4 fillers)	AE0489C820EA7	AE0486C820EA7	AE0485C820EA7
	60	12	5 w/12 (3 fillers)	AE0609C820EA7	AE0606C820EA7	AE0605C820EA7
	72	12	6 w/12 (2 fillers)	AE0729C820EA7	AE0726C820EA7	AE0725C820EA7
	84	12	7 w/12 (1 filler)	AE0849C820EA7	AE0846C820EA7	AE0845C820EA7
96	12	8 w/12 (no fillers)	AE0969C820EA7	AE0966C820EA7	AE0965C820EA7	
144	24	6 w/24 (no fillers)	AE1449O620EB0	AE1446O620EB0	AE1445O620EB0	

Contact customer service for price and availability. Non-zero dispersion-shifted fibers are also available.

Fiber Optic Cable

continued
→



Mini-Span® ADSS Cable

Sag and Tension Information

CABLE	SPAN		INITIAL	INITIAL		NESC LIGHT LOADING			NESC MEDIUM LOADING			NESC HEAVY LOADING		
	feet	meters	SAG	TENSION		SAG	TENSION		SAG	TENSION		SAG	TENSION	
			%	lbs	N		%	lbs		N	%		lbs	N
MINI-SPAN 383	50	15	1.5	20	89	0.5	76	337	2.2	108	482	3.2	161	717
	75	23	1.5	30	133	0.5	103	457	2.4	146	648	3.6	215	956
	100	30	1.5	41	182	0.6	128	568	2.6	179	798	4.0	263	1,171
	125	38	1.5	51	227	0.6	151	671	2.8	211	938	4.2	308	1,370
	150	46	1.5	61	271	0.6	173	768	2.9	240	1,070	4.5	350	1,558
	175	53	1.5	71	316	0.6	194	862	3.0	269	1,196	4.7	390	1,736
	200	61	1.5	81	360	0.7	214	952	3.2	296	1,317	—	—	—
	225	69	1.5	91	405	0.7	234	1,040	3.3	322	1,434	—	—	—
	250	76	1.5	101	449	0.7	253	1,125	3.4	348	1,547	—	—	—
	275	84	1.5	112	498	0.7	272	1,209	3.5	372	1,657	—	—	—
	300	91	1.5	122	543	0.7	290	1,290	3.5	397	1,765	—	—	—
	325	99	1.5	132	587	0.8	308	1,370	—	—	—	—	—	—
	350	107	1.5	142	632	0.8	325	1,448	—	—	—	—	—	—
	375	114	1.5	152	676	0.8	343	1,525	—	—	—	—	—	—
	400	122	1.5	162	721	0.8	360	1,601	—	—	—	—	—	—
	425	130	1.5	172	765	0.8	377	1,676	—	—	—	—	—	—
450	137	1.5	183	814	0.8	393	1,750	—	—	—	—	—	—	
MINI-SPAN 424	50	15	1.0	35	156	0.4	104	463	1.7	142	632	2.6	207	921
	75	23	1.0	53	236	0.4	142	632	1.9	191	850	3.0	275	1,223
	100	30	1.0	71	316	0.5	176	783	2.1	235	1,095	3.2	337	1,499
	125	38	1.0	88	391	0.5	208	925	2.2	276	1,228	3.4	395	1,757
	150	46	1.0	106	472	0.5	238	1,059	2.4	315	1,401	3.6	449	1,997
	175	53	1.0	124	552	0.5	268	1,192	2.5	353	1,570	3.8	501	2,229
	200	61	1.0	141	627	0.6	296	1,317	2.6	389	1,730	4.0	50	2,447
	225	69	1.0	159	707	0.6	324	1,441	2.7	424	1,886	4.1	598	2,660
	250	76	1.0	177	787	0.6	351	1,561	2.7	458	2,037	4.2	645	2,869
	275	84	1.0	194	863	0.6	378	1,681	2.8	491	2,184	4.3	690	3,069
	300	91	1.0	212	943	0.6	404	1,737	2.8	524	2,331	—	—	—
	325	99	1.0	230	1,023	0.6	429	1,908	2.9	556	2,473	—	—	—
	350	107	1.0	247	1,099	0.6	455	2,024	3.0	587	2,611	—	—	—
	375	114	1.0	265	1,179	0.6	479	2,131	3.0	618	2,749	—	—	—
	400	122	1.0	283	1,259	0.6	504	2,242	3.1	648	2,882	—	—	—
	425	130	1.0	300	1,334	0.7	528	2,349	3.1	678	3,016	—	—	—
	450	137	1.0	318	1,415	0.7	552	2,455	3.2	703	3,145	—	—	—
	475	145	1.0	336	1,495	0.7	576	2,562	—	—	—	—	—	—
	500	152	1.0	353	1,570	0.7	600	2,669	—	—	—	—	—	—
	525	160	1.0	371	1,650	0.7	623	2,771	—	—	—	—	—	—
550	168	1.0	389	1,730	0.7	646	2,874	—	—	—	—	—	—	
575	175	1.0	406	1,806	0.7	669	2,976	—	—	—	—	—	—	
600	183	1.0	424	1,886	0.7	692	3,078	—	—	—	—	—	—	

continued
→

Fiber Optic Cable



Mini-Span® ADSS Cable

Sag and Tension Information

CABLE	SPAN		INITIAL	INITIAL		NESC LIGHT LOADING			NESC MEDIUM LOADING			NESC HEAVY LOADING		
	feet	meters	SAG	TENSION*		SAG	TENSION*		SAG	TENSION*		SAG	TENSION*	
			%	lbs	N	%	lbs	N	%	lbs	N	%	lbs	N
MINI-SPAN 535	50	15	1	62	276	0.4	160	713	1.5	206	918	2.1	297	1,319
	100	30	1	124	552	0.5	274	1,220	1.7	347	1,542	2.5	489	2,176
	150	46	1	187	832	0.6	375	1,670	1.9	469	2,087	2.8	655	2,915
	200	61	1	249	1,108	0.6	469	2,088	2.1	582	2,590	3.1	807	3,588
	250	76	1	311	1,383	0.6	559	2,486	2.2	689	3,063	3.3	948	4,217
	300	91	1	373	1,659	0.6	645	2,868	2.3	790	3,515	3.4	1,082	4,813
	350	107	1	435	1,935	0.7	728	3,239	2.4	888	3,951	3.6	1,210	5,384
	400	122	1	497	2,211	0.7	810	3,601	2.5	983	4,374	3.7	1,334	5,935
	450	137	1	560	2,491	0.7	889	3,956	2.5	1,076	4,785	3.8	1,454	6,469
	500	152	1	622	2,767	0.7	968	4,304	2.6	1,166	5,188	3.9	1,571	6,988
	550	168	1	684	3,043	0.7	1,045	4,647	2.7	1,255	5,583	4.0	1,685	7,495
	575	175	1	715	3,180	0.7	1,083	4,817	2.7	1,299	5,778	4.1	1,741	7,745
	600	183	1	746	3,318	0.7	1,121	4,985	2.7	1,342	5,971	—	—	—
	650	198	1	808	3,594	0.8	1,196	5,320	2.8	1,428	6,353	—	—	—
	700	213	1	870	3,870	0.8	1,270	5,650	2.8	1,513	6,730	—	—	—
	750	229	1	933	4,150	0.8	1,344	5,978	2.8	1,597	7,102	—	—	—
	800	244	1	995	4,426	0.8	1,417	6,303	2.9	1,679	7,469	—	—	—
	850	259	1	1,057	4,702	0.8	1,489	6,625	2.9	1,761	7,833	—	—	—
900	274	1	1,119	4,978	0.8	1,561	6,945	—	—	—	—	—	—	
950	290	1	1,181	5,253	0.8	1,633	7,263	—	—	—	—	—	—	
1,000	305	1	1,243	5,529	0.8	1,704	7,579	—	—	—	—	—	—	
1,050	320	1	1,306	5,809	0.8	1,775	7,894	—	—	—	—	—	—	

* Tensions based on 8 position core used in 96 and fewer fiber designs.

Reel Information

REEL SPECS	REEL A		REEL B		REEL C		REEL D		REEL E	
ITEM	inches	cm	inches	cm	inches	cm	inches	cm	inches	cm
Reel Height	42	106.7	58	147.3	66	167.6	72	182.8	84	213.4
Reel Width Outside	36	91.4	38	96.5	42	106.7	42	106.7	40	101.6
Reel Width Inside	32	81.6	32	81.3	36	91.4	36	91.4	34	86.4
Drum Diameter	23	58.7	28	71.1	36	91.4	36	91.4	35	88.9
Arbor Hole Diameter	3	7.9	3	7.9	3	7.9	3	7.9	3	7.9
Reel Weight with Lagging	180 lbs	82 kg	420 lbs	191 kg	685 lbs	311 kg	710 lbs	320 kg	950 lbs	431 kg
Maximum Cable Length (feet/meters)										
Mini-Span 383	10,827 ft	3,300 m	25,202 ft	7,700 m	32,800 ft	10,000 m	—	—	—	—
Mini-Span 424	8,850 ft	2,700 m	20,250 ft	6,200 m	26,250 ft	8,000 m	32,800 ft	10,000 m	—	—
Mini-Span 535	5,500 ft	1,675 m	12,800 ft	3,900 m	17,225 ft	5,250 m	26,000 ft	6,920 m	32,800 ft	10,000 m

AFL provides ADSS cable on several standard sizes of non-returnable wooden reels. Non-standard reel sizes are available on request.

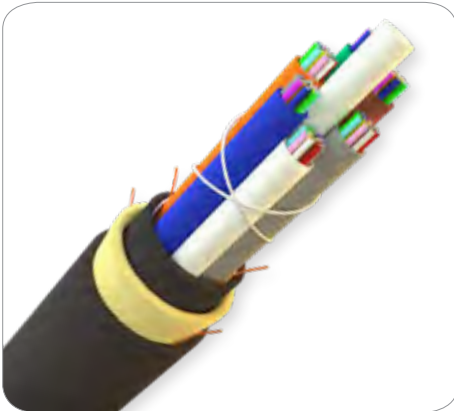

All-Dielectric Self-Supporting (AFL-ADSS®) Fiber Optic Cable

AFL-ADSS® (All-Dielectric Self-Supporting) fiber optic cable is designed for outside plant aerial transmission and distribution environments. As its name indicates, there are no metallic components and the cable does not require a support or messenger wire. These attributes allow the cable to be installed live-line and in the power space of distribution lines.

Features

- Up to 432 fibers in cable
- Designs listed below for span lengths up to 1500 ft (457 m), custom designs available for longer span lengths
- Double jacket designs provide additional protection to the fibers for longer span lengths and higher strength requirements
- Track-resistant outer jacket available for high voltage transmission lines for space potential values up to 25 kV
- Gel-filled tubes are reverse-oscillated (SZ stranded) to allow slack for mid-span access

Applications

- Electric utility transmission and distribution power lines
 - Typically framed under conductors
- Underground duct
- Enterprise OSP networks
- Fiber-to-the-X networks

Cable Components

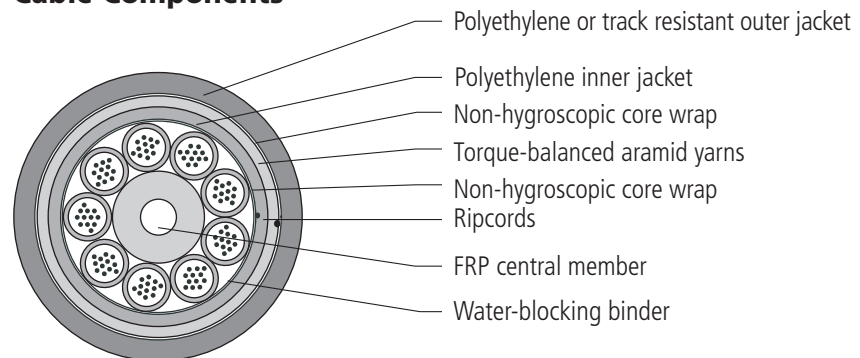

Quote Request Information

NOTE: The designs listed are only a sampling of the options available from AFL. Contact customer service for a cable designed to your exact specifications.

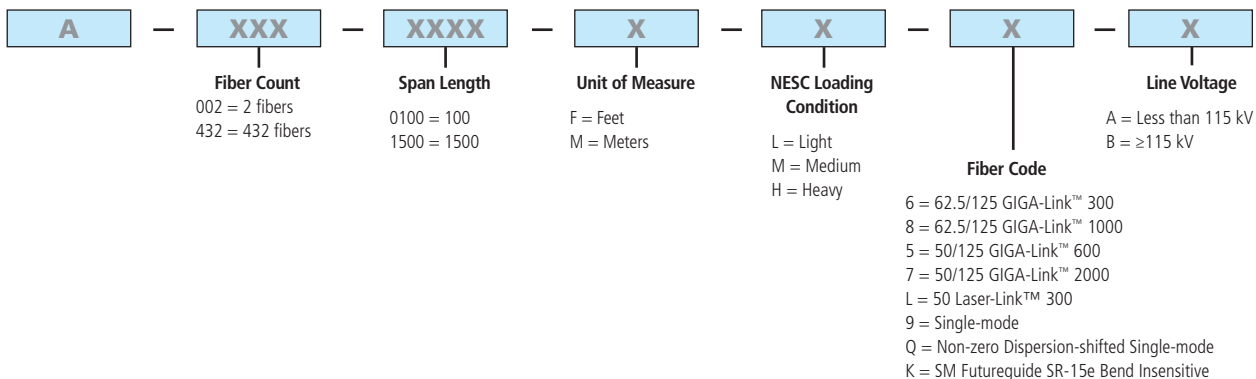

continued
→



All-Dielectric Self-Supporting (AFL-ADSS®) Fiber Optic Cable

Optical Information

FIBER TYPE	MAXIMUM ATTENUATION (dB/km)				OVERFILL LAUNCH MIN. BANDWIDTH (MHz•km)		GIGABIT ETHERNET MINIMUM LINK DISTANCE (meters)	
	850 nm	1300 nm	1310 nm	1550 nm	850 nm	1300 nm	850 nm	1300 nm
(6) 62.5/125 GIGA-Link™ 300	3.5	1.2	N/A	N/A	200	600	300	550
(8) 62.5/125 GIGA-Link™ 1000	3.5	1.2	N/A	N/A	350	600	500	1000
(5) 50/125 GIGA-Link™ 600	2.9	0.9	N/A	N/A	500	500	600	600
(7) 50/125 GIGA-Link™ 2000	2.9	0.9	N/A	N/A	500	800	750	2000
(L) 50 Laser-Link™ 300	3.5	1.2	N/A	N/A	1500	500	900	550
(9) Single-mode	N/A	N/A	0.35	0.25	N/A	N/A	N/A	5000
(Q) Non-zero Dispersion-shifted Single-mode	N/A	N/A	N/A	0.25	N/A	N/A	N/A	N/A
(K) SM Futureguide SR-15e Bend Insensitive	N/A	N/A	0.35	0.25	N/A	N/A	N/A	5000

Gigabit Ethernet Minimum Link Distances are based on "bandwidth"/modal dispersion constraints. Actual link distances may be constrained by attenuation, depending on specific loss budget.

Reel Information

ITEM	REEL A		REEL B		REEL C		REEL D		REEL E	
	INCHES	CM	INCHES	CM	INCHES	CM	INCHES	CM	INCHES	CM
Reel Height	42	106.7	58	147.3	66	167.6	72	167.6	84	213.4
Reel Width Outside	36	91.4	38	96.5	42	106.7	42	106.7	40	101.6
Reel Width Inside	32	81.6	32	81.3	36	91.4	36	91.4	34	86.4
Drum Diameter	23	58.7	28	71.1	36	91.4	36	91.4	35	88.9
Arbor Hole Diameter	3	7.9	3	7.9	3	7.9	3	7.9	3	7.9
Reel Weight with Lagging	180 lbs	82 kg	420 lbs	191 kg	685 lbs	311 kg	710 lbs	311 kg	950 lbs	431 kg

AFL provides ADSS cable on several standard sizes of non-returnable wooden reels. Non-standard reel sizes are available upon request.

Recommended Products for ADSS Fiber Optic Cable

DESCRIPTION	AFL NO.
Fiber Optic Cable Accessories	
ADSS Wedge Deadend	Refer to the ADSS Wedge Deadend spec sheet for specific AFL No.
ADSS Suspension Unit	Refer to the ADSS Suspension Unit spec sheet for specific AFL No.
ADSS Trunnion Assemblies	Refer to the ADSS Trunnion Assemblies spec sheet for specific AFL No.
ADSS Temporary Grip	Refer to the ADSS Temporary Grip spec sheet for specific AFL No.
AGC Downlead Clamp for ADSS	Refer to the AGC Downlead Clamp for ADSS spec sheet for specific AFL No.
AVD Series Spiral Vibration Dampers	Refer to the AVD Series Spiral Vibration Dampers spec sheet for specific AFL No.
Coil Brackets	Refer to the Coil Brackets spec sheet for specific AFL No.
Standoff Bracket for ADSS Hardware Clamps	Refer to the Standoff Bracket for ADSS Hardware Clamps spec sheet for specific AFL No.

Temperature Specifications

TEMPERATURE RANGE	
Operation	-40°C to +70°C
Storage	-50°C to +70°C
Installation	-30°C to +70°C

Qualifications

GOVERNING BODY	STANDARD CODE	COMPONENT
IEEE	1222	Cable
TIA	598-D	Fiber

Contact AFL for your customized ADSS solution.

continued
→



All-Dielectric Self-Supporting (AFL-ADSS®) Fiber Optic Cable

Fiber Optic Cable

NEC LIGHT LOADING @ 1% INSTALLATION SAG												
SPAN		WEIGHT		DIAMETER		MRCL		INITIAL TENSION				
FEET	METERS	LBS/FT	KG/KM	INCHES	MM	LBS	N	UNLOADED		LOADED		
								LBS	N	SAG %	LBS	N
12 FIBERS												
100	30	0.080	119	0.500	12.7	539	2398	100	446	0.6	194	862
200	61	0.080	119	0.500	12.7	539	2398	201	892	0.7	333	1479
300	91	0.080	119	0.500	12.7	539	2398	301	1338	0.7	459	2043
400	122	0.080	119	0.500	12.7	628	2793	401	1785	0.8	597	2654
500	152	0.080	119	0.500	12.7	746	3320	502	2232	0.8	739	3286
600	183	0.080	119	0.500	12.7	936	4162	602	2679	0.8	894	3976
700	213	0.084	125	0.512	13.0	1126	5008	737	3280	0.8	1079	4800
800	244	0.084	125	0.512	13.0	1253	5572	843	3750	0.8	1227	5459
900	274	0.084	126	0.512	13.0	1569	6981	949	4221	0.8	1409	6269
1000	305	0.084	126	0.512	13.0	1569	6981	1054	4690	0.8	1535	6829
1100	335	0.085	126	0.512	13.0	1823	8108	1162	5171	0.8	1708	7595
1200	366	0.090	134	0.528	13.4	1950	8672	1350	6005	0.8	1926	8569
1300	396	0.090	134	0.528	13.4	2203	9799	1463	6508	0.8	2103	9356
1400	427	0.090	134	0.528	13.4	2330	10363	1576	7010	0.8	2258	10044
1500	457	0.090	134	0.528	13.4	2456	10927	1689	7512	0.8	2412	10731
24 FIBERS												
100	30	0.081	121	0.500	12.7	539	2398	102	452	0.6	194	865
200	61	0.081	121	0.500	12.7	539	2398	203	904	0.7	334	1486
300	91	0.081	121	0.500	12.7	539	2398	305	1356	0.7	462	2053
400	122	0.081	121	0.500	12.7	628	2793	407	1808	0.8	600	2668
500	152	0.081	121	0.500	12.7	746	3320	508	2261	0.8	743	3304
600	183	0.081	121	0.500	12.7	936	4162	610	2714	0.8	899	3998
700	213	0.085	127	0.512	13.0	1126	5008	747	3322	0.8	1085	4826
800	244	0.085	127	0.512	13.0	1253	5572	854	3797	0.8	1234	5489
900	274	0.085	127	0.512	13.0	1569	6981	961	4274	0.8	1416	6301
1000	305	0.085	127	0.512	13.0	1696	7545	1068	4750	0.8	1566	6965
1100	335	0.086	127	0.512	13.0	1823	8108	1177	5236	0.8	1717	7635
1200	366	0.091	135	0.528	13.4	1950	8672	1366	6075	0.8	1937	8614
1300	396	0.091	136	0.528	13.4	2203	9799	1480	6584	0.8	2114	9405
1400	427	0.091	136	0.528	13.4	2456	10927	1595	7094	0.8	2292	10194
1500	457	0.091	136	0.528	13.4	2583	11490	1709	7602	0.8	2447	10886
36 FIBERS												
100	30	0.082	123	0.500	12.7	539	2398	103	458	0.6	195	867
200	61	0.082	123	0.500	12.7	598	2661	206	916	0.7	343	1526
300	91	0.082	123	0.500	12.7	598	2661	309	1375	0.8	464	2064
400	122	0.082	123	0.500	12.7	598	2661	412	1833	0.8	598	2660
500	152	0.082	123	0.500	12.7	776	3452	515	2291	0.8	752	3345
600	183	0.082	123	0.500	12.7	999	4444	618	2749	0.8	915	4070
700	213	0.086	129	0.512	13.0	1189	5290	756	3363	0.8	1102	4902
800	244	0.086	129	0.512	13.0	1253	5572	864	3843	0.8	1241	5520
900	274	0.086	129	0.512	13.0	1569	6981	973	4328	0.8	1424	6334
1000	305	0.086	129	0.512	13.0	1569	6981	1081	4809	0.8	1552	6904
1100	335	0.087	129	0.512	13.0	1823	8108	1192	5302	0.8	1726	7678
1200	366	0.092	137	0.528	13.4	2076	9236	1382	6147	0.8	1969	8759
1300	396	0.092	137	0.528	13.4	2203	9799	1497	6659	0.8	2125	9452
1400	427	0.092	137	0.528	13.4	2330	10363	1613	7175	0.8	2281	10146
1500	457	0.092	137	0.528	13.4	2456	10927	1728	7687	0.8	2438	10845

* Initial tension indicates tension before 10 year creep.

continued
→



All-Dielectric Self-Supporting (AFL-ADSS®) Fiber Optic Cable

NEC LIGHT LOADING @ 1% INSTALLATION SAG												
SPAN		WEIGHT		DIAMETER		MRCL		INITIAL TENSION				
FEET	METERS	LBS/FT	KG/KM	INCHES	MM	LBS	N	UNLOADED		LOADED		
								LBS	N	SAG %	LBS	N
48 FIBERS												
100	30	0.083	124	0.500	12.7	539	2398	104	463	0.6	196	872
200	61	0.083	124	0.500	12.7	598	2661	209	930	0.7	344	1530
300	91	0.083	124	0.500	12.7	598	2661	313	1392	0.7	476	2117
400	122	0.083	124	0.500	12.7	628	2793	417	1855	0.8	606	2696
500	152	0.083	124	0.500	12.7	776	3452	522	2322	0.8	756	3363
600	183	0.083	124	0.500	12.7	999	4444	626	2785	0.8	920	4092
700	213	0.087	130	0.512	13.0	1189	5290	765	3403	0.8	1108	4929
800	244	0.087	130	0.512	13.0	1253	5572	875	3892	0.8	1247	5547
900	274	0.088	130	0.512	13.0	1569	6981	985	4381	0.8	1431	6365
1000	305	0.088	130	0.512	13.0	1569	6981	1094	4866	0.8	1560	6939
1100	335	0.088	131	0.512	13.0	1823	8108	1206	5365	0.8	1735	7718
1200	366	0.093	139	0.528	13.4	2076	9236	1398	6219	0.8	1979	8803
1300	396	0.093	139	0.528	13.4	2330	10363	1515	6739	0.8	2158	9599
1400	427	0.093	139	0.528	13.4	2456	10927	1632	7259	0.8	2315	10298
1500	457	0.093	139	0.528	13.4	2456	10927	1748	7775	0.8	2450	10898
60 FIBERS												
100	30	0.084	126	0.500	12.7	539	2398	106	472	0.6	197	876
200	61	0.084	126	0.500	12.7	539	2398	211	939	0.7	339	1508
300	91	0.084	126	0.500	12.7	539	2398	317	1410	0.8	469	2086
400	122	0.084	126	0.500	12.7	628	2793	422	1877	0.8	610	2713
500	152	0.085	126	0.500	12.7	809	3599	528	2349	0.8	766	3407
600	183	0.085	126	0.500	12.7	936	4162	634	2820	0.8	914	4066
700	213	0.089	132	0.512	13.0	1126	5008	775	3447	0.8	1102	4902
800	244	0.089	132	0.512	13.0	1316	5854	885	3937	0.8	1265	5627
900	274	0.089	132	0.512	13.0	1569	6981	997	4435	0.8	1439	6401
1000	305	0.089	132	0.512	13.0	1569	6981	1107	4924	0.8	1568	6975
1100	335	0.089	132	0.512	13.0	1823	8108	1221	5431	0.8	1744	7758
1200	366	0.094	140	0.528	13.4	2076	9236	1414	6290	0.8	1989	8848
1300	396	0.094	140	0.528	13.4	2330	10363	1532	6815	0.8	2169	9648
1400	427	0.094	140	0.528	13.4	2330	10363	1650	7340	0.8	2305	10253
1500	457	0.094	140	0.528	13.4	2710	12054	1769	7869	0.8	2507	11152
72 FIBERS												
100	30	0.100	148	0.535	13.6	854	3797	125	556	0.6	235	1045
200	61	0.100	148	0.535	13.6	854	3797	249	1108	0.7	405	1802
300	91	0.100	148	0.535	13.6	854	3797	374	1664	0.7	561	2495
400	122	0.100	148	0.535	13.6	854	3797	499	2220	0.8	709	3154
500	152	0.100	148	0.535	13.6	854	3797	623	2771	0.8	853	3794
600	183	0.100	149	0.535	13.6	1031	4587	748	3327	0.8	1025	4559
700	213	0.108	161	0.559	14.2	1314	5843	949	4221	0.8	1280	5694
800	244	0.108	161	0.559	14.2	1504	6689	1084	4822	0.8	1464	6512
900	274	0.108	161	0.559	14.2	1884	8380	1221	5431	0.8	1677	7460
1000	305	0.108	161	0.559	14.2	1884	8380	1356	6032	0.8	1831	8145
1100	335	0.109	161	0.559	14.2	2011	8943	1492	6637	0.8	2004	8914
1200	366	0.109	162	0.559	14.2	2264	10071	1628	7242	0.8	2198	9777
1300	396	0.109	162	0.559	14.2	2391	10634	1767	7860	0.8	2374	10560
1400	427	0.109	162	0.559	14.2	2644	11762	1903	8465	0.8	2568	11423
1500	457	0.109	162	0.559	14.2	2771	12326	2040	9074	0.8	2741	12193

* Initial tension indicates tension before 10 year creep.

continued
→

All-Dielectric Self-Supporting (AFL-ADSS®) Fiber Optic Cable

Fiber Optic Cable

NEC LIGHT LOADING @ 1% INSTALLATION SAG												
SPAN		WEIGHT		DIAMETER		MRCL		INITIAL TENSION				
FEET	METERS	LBS/FT	KG/KM	INCHES	MM	LBS	N	UNLOADED		LOADED		
								LBS	N	SAG %	LBS	N
84 FIBERS												
100	30	0.131	195	0.610	15.5	1296	5763	164	730	0.6	295	1312
200	61	0.131	195	0.610	15.5	1296	5763	328	1459	0.7	512	2277
300	91	0.131	195	0.610	15.5	1296	5763	492	2189	0.8	712	3167
400	122	0.131	195	0.610	15.5	1296	5763	656	2918	0.8	903	4017
500	152	0.131	195	0.610	15.5	1296	5763	820	3648	0.8	1089	4844
600	183	0.131	195	0.610	15.5	1296	5763	984	4377	0.9	1270	5649
700	213	0.131	195	0.610	15.5	1503	6685	1148	5107	0.9	1481	6588
800	244	0.131	195	0.610	15.5	1692	7528	1313	5841	0.9	1689	7513
900	274	0.131	195	0.610	15.5	1946	8655	1477	6570	0.9	1907	8483
1000	305	0.138	205	0.626	15.9	2326	10346	1725	7673	0.9	2216	9857
1100	335	0.138	205	0.626	15.9	2453	10910	1898	8443	0.9	2422	10774
1200	366	0.138	205	0.626	15.9	2706	12037	2071	9212	0.9	2647	11774
1300	396	0.138	206	0.626	15.9	2960	13165	2244	9982	0.9	2872	12775
1400	427	0.138	206	0.626	15.9	3086	13728	2417	10751	0.9	3079	13696
1500	457	0.138	206	0.626	15.9	3340	14856	2590	11521	0.9	3304	14697
96 FIBERS												
100	30	0.132	197	0.610	15.5	1296	5763	165	734	0.6	296	1317
200	61	0.132	197	0.610	15.5	1296	5763	331	1472	0.7	514	2286
300	91	0.132	197	0.610	15.5	1296	5763	496	2206	0.8	715	3180
400	122	0.132	197	0.610	15.5	1296	5763	661	2940	0.8	907	4035
500	152	0.132	197	0.610	15.5	1296	5763	827	3679	0.8	1093	4862
600	183	0.132	197	0.610	15.5	1296	5763	992	4413	0.9	1276	5676
700	213	0.132	197	0.610	15.5	1503	6685	1158	5151	0.9	1488	6619
800	244	0.132	197	0.610	15.5	1756	7810	1324	5889	0.9	1706	7589
900	274	0.132	197	0.610	15.5	1946	8655	1489	6623	0.9	1915	8518
1000	305	0.139	207	0.626	15.9	2326	10346	1738	7731	0.9	2225	9897
1100	335	0.139	207	0.626	15.9	2453	10910	1912	8505	0.9	2433	10823
1200	366	0.139	207	0.626	15.9	2706	12037	2087	9283	0.9	2659	11828
1300	396	0.139	207	0.626	15.9	2960	13165	2261	10057	0.9	2885	12833
1400	427	0.139	207	0.626	15.9	3213	14292	2436	10836	0.9	3111	13838
1500	457	0.139	207	0.626	15.9	3340	14856	2610	11610	0.9	3319	14764
108 FIBERS												
100	30	0.170	254	0.685	17.4	2070	9207	213	947	0.6	371	1650
200	61	0.170	254	0.685	17.4	2070	9207	426	1895	0.7	648	2882
300	91	0.170	254	0.685	17.4	2070	9207	639	2842	0.8	904	4021
400	122	0.170	254	0.685	17.4	2070	9207	852	3790	0.8	1149	5111
500	152	0.170	254	0.685	17.4	2070	9207	1065	4737	0.8	1387	6170
600	183	0.170	254	0.685	17.4	2070	9207	1278	5685	0.9	1621	7211
700	213	0.170	254	0.685	17.4	2070	9207	1491	6632	0.9	1851	8234
800	244	0.170	254	0.685	17.4	2129	9470	1704	7580	0.9	2087	9283
900	274	0.178	264	0.701	17.8	2467	10972	1999	8892	0.9	2430	10809
1000	305	0.178	265	0.701	17.8	2720	12099	2222	9884	0.9	2698	12001
1100	335	0.178	265	0.701	17.8	3100	13790	2447	10885	0.9	2984	13273
1200	366	0.178	265	0.701	17.8	3354	14918	2670	11877	0.9	3252	14466
1300	396	0.178	265	0.701	17.8	3607	16045	2893	12869	0.9	3520	15658
1400	427	0.178	265	0.701	17.8	3860	17172	3117	13865	0.9	3789	16854
1500	457	0.178	265	0.701	17.8	4114	18300	3340	14857	0.9	4057	18046

* Initial tension indicates tension before 10 year creep.

continued
→



All-Dielectric Self-Supporting (AFL-ADSS®) Fiber Optic Cable

NEC LIGHT LOADING @ 1% INSTALLATION SAG												
SPAN		WEIGHT		DIAMETER		MRCL		INITIAL TENSION				
FEET	METERS	LBS/FT	KG/KM	INCHES	MM	LBS	N	UNLOADED		LOADED		
								LBS	N	SAG %	LBS	N
120 FIBERS												
100	30	0.171	255	0.685	17.4	2070	9207	214	952	0.6	371	1650
200	61	0.171	255	0.685	17.4	2070	9207	429	1908	0.7	650	2891
300	91	0.171	255	0.685	17.4	2070	9207	643	2860	0.8	906	4030
400	122	0.171	255	0.685	17.4	2070	9207	857	3812	0.8	1152	5124
500	152	0.171	255	0.685	17.4	2070	9207	1072	4768	0.8	1392	6192
600	183	0.171	255	0.685	17.4	2070	9207	1286	5720	0.9	1627	7237
700	213	0.171	255	0.685	17.4	2070	9207	1501	6677	0.9	1858	8265
800	244	0.172	255	0.685	17.4	2129	9470	1715	7629	0.9	2095	9319
900	274	0.179	266	0.701	17.8	2467	10972	2011	8945	0.9	2440	10854
1000	305	0.179	266	0.701	17.8	2720	12099	2235	9942	0.9	2709	12050
1100	335	0.179	266	0.701	17.8	3100	13790	2462	10952	0.9	2995	13322
1200	366	0.179	267	0.701	17.8	3354	14918	2686	11948	0.9	3264	14519
1300	396	0.179	267	0.701	17.8	3607	16045	2911	12949	0.9	3533	15716
1400	427	0.179	267	0.701	17.8	3860	17172	3136	13950	0.9	3803	16917
1500	457	0.179	267	0.701	17.8	4114	18300	3360	14946	0.9	4072	18113
132 FIBERS												
100	30	0.208	310	0.764	19.4	2070	9207	260	1157	0.7	415	1846
200	61	0.208	310	0.764	19.4	2070	9207	520	2313	0.8	734	3265
300	91	0.208	310	0.764	19.4	2070	9207	780	3470	0.8	1031	4586
400	122	0.208	310	0.764	19.4	2070	9207	1040	4626	0.9	1318	5863
500	152	0.208	310	0.764	19.4	2070	9207	1300	5783	0.9	1599	7113
600	183	0.208	310	0.764	19.4	2070	9207	1560	6939	0.9	1875	8340
700	213	0.208	310	0.764	19.4	2188	9734	1821	8100	0.9	2163	9622
800	244	0.208	310	0.764	19.4	2530	11253	2081	9257	0.9	2476	11014
900	274	0.208	310	0.764	19.4	2783	12381	2342	10418	0.9	2778	12357
1000	305	0.216	322	0.780	19.8	3227	14354	2704	12028	0.9	3194	14208
1100	335	0.216	322	0.780	19.8	3607	16045	2975	13233	0.9	3521	15662
1200	366	0.217	322	0.780	19.8	3860	17172	3248	14448	0.9	3835	17059
1300	396	0.217	322	0.780	19.8	4241	18863	3520	15658	0.9	4162	18513
1400	427	0.217	322	0.780	19.8	4494	19991	3792	16868	0.9	4475	19906
1500	457	0.217	323	0.780	19.8	4874	21682	4064	18078	0.9	4802	21360
144 FIBERS												
100	30	0.209	311	0.764	19.4	2070	9207	261	1161	0.7	416	1850
200	61	0.209	311	0.764	19.4	2070	9207	523	2326	0.8	736	3274
300	91	0.209	311	0.764	19.4	2070	9207	784	3487	0.8	1034	4599
400	122	0.209	311	0.764	19.4	2070	9207	1046	4653	0.9	1322	5881
500	152	0.209	311	0.764	19.4	2070	9207	1307	5814	0.9	1604	7135
600	183	0.209	311	0.764	19.4	2070	9207	1568	6975	0.9	1882	8372
700	213	0.209	311	0.764	19.4	2188	9734	1830	8140	0.9	2170	9653
800	244	0.209	311	0.764	19.4	2530	11253	2092	9306	0.9	2484	11049
900	274	0.209	311	0.764	19.4	2847	12663	2354	10471	0.9	2795	12433
1000	305	0.217	324	0.780	19.8	3227	14354	2717	12086	0.9	3205	14257
1100	335	0.217	324	0.780	19.8	3607	16045	2990	13300	0.9	3533	15716
1200	366	0.218	324	0.780	19.8	3860	17172	3265	14523	0.9	3848	17117
1300	396	0.218	324	0.780	19.8	4241	18863	3538	15738	0.9	4176	18576
1400	427	0.218	324	0.780	19.8	4494	19991	3811	16952	0.9	4489	19968
1500	457	0.218	324	0.780	19.8	4874	21682	4084	18167	0.9	4818	21432

* Initial tension indicates tension before 10 year creep.

continued
→



All-Dielectric Self-Supporting (AFL-ADSS®) Fiber Optic Cable

NEC LIGHT LOADING @ 1% INSTALLATION SAG

SPAN		WEIGHT		DIAMETER		MRCL		INITIAL TENSION				
FEET	METERS	LBS/FT	KG/KM	INCHES	MM	LBS	N	UNLOADED		LOADED		
								LBS	N	SAG %	LBS	N
216 FIBERS												
100	30	0.202	301	0.780	19.8	854	3797	253	1125	0.8	353	1570
200	61	0.202	301	0.780	19.8	854	3797	505	2246	0.9	635	2825
300	91	0.202	301	0.780	19.8	913	4060	758	3372	0.9	911	4052
400	122	0.202	301	0.780	19.8	1250	5561	1011	4497	0.9	1219	5422
500	152	0.202	301	0.780	19.8	1630	7252	1264	5623	0.9	1533	6819
600	183	0.202	301	0.780	19.8	1884	8380	1517	6748	0.9	1831	8145
700	213	0.211	313	0.795	20.2	2264	10071	1843	8198	0.9	2208	9822
800	244	0.211	313	0.795	20.2	2517	11198	2106	9368	0.9	2516	11192
900	274	0.211	314	0.795	20.2	2898	12889	2371	10547	0.9	2839	12629
1000	305	0.211	314	0.795	20.2	3151	14017	2634	11717	0.9	3147	13999
1100	335	0.211	314	0.795	20.2	3531	15708	2899	12895	0.9	3470	15435
1200	366	0.211	314	0.795	20.2	3785	16835	3163	14070	0.9	3778	16805
1300	396	0.219	326	0.811	20.6	4292	19090	3564	15853	0.9	4238	18852
1400	427	0.220	327	0.811	20.6	4689	20857	3845	17103	0.9	4577	20360
1500	457	0.220	327	0.811	20.6	5069	22548	4121	18331	0.9	4909	21836
288 FIBERS												
100	30	0.259	385	0.890	22.6	1296	5763	323	1439	0.8	444	1975
200	61	0.259	385	0.890	22.6	1296	5763	647	2878	0.9	802	3569
300	91	0.259	385	0.890	22.6	1296	5763	970	4317	0.9	1146	5096
400	122	0.259	385	0.890	22.6	1566	6964	1294	5757	0.9	1511	6723
500	152	0.259	385	0.890	22.6	2072	9219	1618	7198	0.9	1901	8457
600	183	0.259	385	0.890	22.6	2326	10346	1942	8639	0.9	2265	10077
700	213	0.259	385	0.890	22.6	2706	12037	2267	10082	0.9	2643	11755
800	244	0.259	386	0.890	22.6	3086	13728	2591	11525	0.9	3020	13434
900	274	0.269	400	0.906	23.0	3593	15983	3023	13447	0.9	3507	15602
1000	305	0.269	400	0.906	23.0	3973	17674	3360	14945	0.9	3896	17330
1100	335	0.269	400	0.906	23.0	4354	19365	3697	16444	0.9	4284	19058
1200	366	0.269	400	0.906	23.0	4734	21056	4034	17943	0.9	4673	20787
1300	396	0.268	399	0.921	23.4	5069	22548	4354	19368	0.9	5062	22516
1400	427	0.268	399	0.921	23.4	5576	24803	4691	20865	0.9	5464	24307
1500	457	0.268	399	0.921	23.4	5956	26494	5027	22361	0.9	5854	26039
432 FIBERS												
100	30	0.298	444	0.953	24.2	1296	5763	373	1658	0.8	487	2168
200	61	0.298	444	0.953	24.2	1296	5763	745	3316	0.9	890	3959
300	91	0.298	444	0.953	24.2	1296	5763	1118	4974	0.9	1279	5689
400	122	0.298	444	0.953	24.2	1756	7810	1491	6634	0.9	1708	7598
500	152	0.298	444	0.953	24.2	2326	10346	1865	8295	0.9	2148	9554
600	183	0.298	444	0.953	24.2	2579	11474	2238	9956	0.9	2558	11379
700	213	0.299	444	0.953	24.2	3086	13728	2612	11619	0.9	2992	13310
800	244	0.299	444	0.953	24.2	3466	15419	2986	13281	0.9	3415	15189
900	274	0.309	459	0.969	24.6	3973	17674	3473	15448	0.9	3952	17580
1000	305	0.309	460	0.969	24.6	4480	19929	3860	17170	0.9	4398	19564
1100	335	0.309	460	0.969	24.6	4860	21620	4247	18891	0.9	4832	21496
1200	366	0.320	476	0.984	25.0	5449	24239	4796	21333	0.9	5433	24168
1300	396	0.320	476	0.984	25.0	5956	26494	5197	23118	0.9	5892	26208
1400	427	0.319	474	0.984	25.0	6336	28185	5576	24804	0.9	6321	28118
1500	457	0.319	474	0.984	25.0	6970	31003	5977	26585	0.9	6791	30207

* Initial tension indicates tension before 10 year creep.

continued
→



All-Dielectric Self-Supporting (AFL-ADSS®) Fiber Optic Cable

NESC MEDIUM LOADING @ 1% INSTALLATION SAG													
SPAN		WEIGHT		DIAMETER		MRCL		INITIAL TENSION					
FEET	METERS	LBS/FT	KG/KM	INCHES	MM	LBS	N	UNLOADED		LOADED			
								LBS	N	SAG %	LBS	N	
12 FIBERS													
100	30	0.08	119	0.5	12.7	539	2398	100	446	2.3	242	1074	
200	61	0.08	119	0.5	12.7	539	2398	201	892	2.8	406	1807	
300	91	0.08	119	0.5	12.7	598	2661	301	1339	3.0	518	2304	
400	122	0.08	119	0.5	12.7	746	3320	401	1785	3.0	744	3311	
500	152	0.08	120	0.5	12.7	999	4444	502	2232	3.0	946	4206	
600	183	0.084	125	0.512	13	1189	5290	632	2812	2.9	1055	4694	
700	213	0.084	126	0.512	13	1569	6981	738	3283	2.9	1387	6168	
800	244	0.084	126	0.512	13	1569	6981	844	3752	3.0	1536	6834	
900	274	0.085	126	0.512	13	1823	8108	951	4231	3.0	1742	7751	
1000	305	0.09	134	0.528	13.4	2076	9236	1125	5005	2.9	1825	8118	
1100	335	0.09	134	0.528	13.4	2203	9799	1238	5506	3.0	2180	9698	
1200	366	0.09	134	0.528	13.4	2456	10927	1351	6010	2.9	2391	10634	
1300	396	0.09	134	0.528	13.4	2583	11490	1464	6512	3.0	2573	11444	
1400	427	0.09	134	0.528	13.4	2837	12618	1577	7016	3.0	2783	12380	
1500	457	0.09	134	0.528	13.4	3090	13745	1691	7520	2.9	2994	13316	
M E D I U M	24 FIBERS												
	100	30	0.081	121	0.5	12.7	539	2398	102	452	2.3	242	1078
	200	61	0.081	121	0.5	12.7	539	2398	203	904	2.8	408	1813
	300	91	0.081	121	0.5	12.7	598	2661	305	1356	3.0	520	2314
	400	122	0.081	121	0.5	12.7	776	3452	407	1809	3.0	754	3355
	500	152	0.081	121	0.5	12.7	999	4444	508	2262	3.0	950	4224
	600	183	0.085	127	0.512	13	1189	5290	640	2847	3.0	1060	4717
	700	213	0.085	127	0.512	13	1569	6981	747	3324	2.9	1392	6192
	800	244	0.085	127	0.512	13	1696	7545	854	3800	2.9	1571	6986
	900	274	0.086	127	0.512	13	1823	8108	963	4284	3.0	1750	7782
	1000	305	0.091	136	0.528	13.4	2076	9236	1138	5064	2.9	1833	8152
	1100	335	0.091	136	0.528	13.4	2203	9799	1252	5571	3.0	2189	9737
	1200	366	0.091	136	0.528	13.4	2456	10927	1367	6080	2.9	2400	10676
	1300	396	0.091	136	0.528	13.4	2583	11490	1481	6588	3.0	2583	11490
	1400	427	0.091	136	0.528	13.4	2837	12618	1596	7098	2.9	2794	12490
	1500	457	0.091	136	0.528	13.4	3090	13745	1710	7608	2.9	3006	13369
		36 FIBERS											
		100	30	0.082	123	0.500	12.7	539	2398	103	458	2.3	243
200		61	0.082	123	0.500	12.7	598	2661	206	916	2.7	420	1868
300		91	0.082	123	0.500	12.7	598	2661	309	1375	3.0	572	2544
400		122	0.082	123	0.500	12.7	776	3452	412	1833	3.0	757	3367
500		152	0.082	123	0.500	12.7	999	4444	515	2291	3.0	953	4239
600		183	0.086	129	0.512	13.0	1189	5290	648	2882	3.0	1164	5178
700		213	0.086	129	0.512	13.0	1506	6699	756	3363	2.9	1384	6156
800		244	0.087	129	0.512	13.0	1823	8108	867	3857	2.9	1604	7135
900		274	0.087	129	0.512	13.0	1823	8108	975	4337	2.9	1757	7816
1000		305	0.092	137	0.528	13.4	2076	9236	1152	5124	2.9	2014	8959
1100		335	0.092	137	0.528	13.4	2456	10927	1268	5640	2.9	2252	10017
1200	366	0.092	137	0.528	13.4	2456	10927	1383	6152	2.9	2410	10720	
1300	396	0.092	137	0.528	13.4	2710	12054	1499	6668	2.9	2621	11659	
1400	427	0.092	137	0.528	13.4	2837	12618	1614	7179	2.9	2806	12482	
1500	457	0.092	137	0.528	13.4	3090	13745	1730	7695	2.9	3017	13420	

* Initial tension indicates tension before 10 year creep.

continued
→

All-Dielectric Self-Supporting (AFL-ADSS®) Fiber Optic Cable

NEC MEDIUM LOADING @ 1% INSTALLATION SAG

SPAN		WEIGHT		DIAMETER		MRCL		INITIAL TENSION				
FEET	METERS	LBS/FT	KG/KM	INCHES	MM	LBS	N	UNLOADED		LOADED		
								LBS	N	SAG %	LBS	N
48 FIBERS												
100	30	0.083	124	0.5	12.7	539	2398	104	463	2.3	244	1085
200	61	0.083	124	0.5	12.7	598	2661	209	930	2.7	421	1873
300	91	0.083	124	0.5	12.7	598	2661	313	1392	3.0	574	2553
400	122	0.083	124	0.5	12.7	776	3452	417	1855	3.0	761	3385
500	152	0.083	124	0.5	12.7	999	4444	522	2322	3.0	957	4257
600	183	0.087	130	0.512	13.0	1189	5290	656	2918	3.0	1169	5200
700	213	0.088	130	0.512	13.0	1506	6699	766	3407	2.9	1390	6183
800	244	0.088	131	0.512	13.0	1823	8108	877	3901	2.9	1610	7162
900	274	0.088	131	0.512	13.0	1823	8108	987	4390	2.9	1764	7847
1000	305	0.093	139	0.528	13.4	2076	9236	1165	5182	2.9	2018	8220
1100	335	0.093	139	0.528	13.4	2456	10927	1282	5703	2.9	2261	10057
1200	366	0.093	139	0.528	13.4	2456	10927	1399	6223	2.9	2419	10760
1300	396	0.093	139	0.528	13.4	2710	12054	1516	6744	2.9	2632	11708
1400	427	0.093	139	0.528	13.4	2963	13182	1633	7264	2.9	2844	12651
1500	457	0.093	139	0.528	13.4	3090	13745	1750	7784	2.9	3029	13474
60 FIBERS												
100	30	0.084	126	0.500	12.7	539	2398	106	472	2.3	244	1085
200	61	0.084	126	0.500	12.7	539	2398	211	939	2.8	412	1833
300	91	0.084	126	0.500	12.7	598	2661	317	1410	3.0	576	2562
400	122	0.085	126	0.500	12.7	776	3452	423	1882	3.0	764	3398
500	152	0.085	126	0.500	12.7	999	4444	528	2349	3.0	961	4275
600	183	0.089	132	0.512	13.0	1189	5290	664	2954	3.0	1174	5222
700	213	0.089	132	0.512	13.0	1379	6135	775	3447	3.0	1368	6085
800	244	0.089	132	0.512	13.0	1569	6981	886	3941	3.0	1562	6948
900	274	0.089	132	0.512	13.0	1823	8108	999	4444	2.9	1771	7878
1000	305	0.094	140	0.528	13.4	2076	9236	1178	5240	2.9	2030	9030
1100	335	0.094	140	0.528	13.4	2330	10363	1296	5765	2.9	2243	9977
1200	366	0.094	140	0.528	13.4	2456	10927	1414	6290	2.9	2429	10805
1300	396	0.094	140	0.528	13.4	2710	12054	1533	6819	2.9	2642	11752
1400	427	0.094	140	0.528	13.4	2963	13182	1652	7348	2.9	2856	12704
1500	457	0.094	140	0.528	13.4	3090	13745	1770	7873	2.9	3042	13531
72 FIBERS												
100	30	0.100	148	0.535	13.6	854	3797	125	556	2.1	290	1290
200	61	0.100	148	0.535	13.6	854	3797	249	1108	2.5	489	2175
300	91	0.100	148	0.535	13.6	854	3797	374	1664	2.7	668	2971
400	122	0.100	148	0.535	13.6	854	3797	499	2220	2.9	836	3719
500	152	0.100	149	0.535	13.6	1061	4719	624	2776	2.9	1044	4644
600	183	0.108	161	0.559	14.2	1314	5843	813	3616	2.9	1310	5827
700	213	0.108	161	0.559	14.2	1567	6970	949	4221	2.9	1536	6832
800	244	0.108	161	0.559	14.2	1884	8380	1085	4826	2.8	1775	7896
900	274	0.109	161	0.559	14.2	2011	8943	1221	5431	2.9	1975	8785
1000	305	0.109	162	0.559	14.2	2264	10071	1357	6036	2.8	2201	9791
1100	335	0.109	162	0.559	14.2	2517	11198	1495	6650	2.8	2428	10800
1200	366	0.109	162	0.559	14.2	2644	11762	1631	7255	2.9	2628	11690
1300	396	0.109	162	0.559	14.2	2898	12889	1768	7864	2.9	2854	12695
1400	427	0.109	162	0.559	14.2	3151	14017	1905	8474	2.8	3080	13701
1500	457	0.115	171	0.575	14.6	3405	15144	2153	9577	2.8	3392	15088

* Initial tension indicates tension before 10 year creep.

continued
→

Fiber Optic Cable

M E D I U M



All-Dielectric Self-Supporting (AFL-ADSS®) Fiber Optic Cable

M E D I U M												
NESC MEDIUM LOADING @ 1% INSTALLATION SAG												
SPAN		WEIGHT		DIAMETER		MRCL		INITIAL TENSION				
FEET	METERS	LBS/FT	KG/KM	INCHES	MM	LBS	N	UNLOADED		LOADED		
								LBS	N	SAG %	LBS	N
84 FIBERS												
100	30	0.131	195	0.610	15.5	1296	5763	164	730	1.9	354	1575
200	61	0.131	195	0.610	15.5	1296	5763	328	1459	2.3	602	2678
300	91	0.131	195	0.610	15.5	1296	5763	492	2189	2.5	826	3674
400	122	0.131	195	0.610	15.5	1296	5763	656	2918	2.6	1037	4613
500	152	0.131	195	0.610	15.5	1296	5763	820	3648	2.7	1240	5516
600	183	0.131	195	0.610	15.5	1473	6554	984	4377	2.8	1473	6552
700	213	0.131	195	0.610	15.5	1756	7810	1149	5111	2.8	1726	7678
800	244	0.131	195	0.610	15.5	2009	8937	1313	5841	2.8	1973	8776
900	274	0.138	205	0.626	15.9	2326	10346	1552	6904	2.7	2291	10191
1000	305	0.138	205	0.626	15.9	2579	11474	1725	7673	2.7	2545	11321
1100	335	0.138	205	0.626	15.9	2833	12601	1898	8443	2.7	2799	12451
1200	366	0.138	206	0.626	15.9	3086	13728	2072	9217	2.7	3053	13580
1300	396	0.138	206	0.626	15.9	3340	14856	2245	9986	2.7	3307	14710
1400	427	0.138	206	0.626	15.9	3593	15983	2418	10756	2.7	3562	15845
1500	457	0.145	216	0.642	16.3	3973	17674	2716	12081	2.7	3938	17517
96 FIBERS												
100	30	0.132	197	0.610	15.5	1296	5763	165	734	1.9	354	1575
200	61	0.132	197	0.610	15.5	1296	5763	331	1472	2.3	604	2687
300	91	0.132	197	0.610	15.5	1296	5763	496	2206	2.5	829	3688
400	122	0.132	197	0.610	15.5	1296	5763	661	2940	2.6	1041	4631
500	152	0.132	197	0.610	15.5	1296	5763	827	3679	2.7	1245	5538
600	183	0.132	197	0.610	15.5	1503	6685	992	4413	2.8	1484	6601
700	213	0.132	197	0.610	15.5	1756	7810	1158	5151	2.8	1732	7704
800	244	0.132	197	0.610	15.5	2009	8937	1324	5889	2.8	1980	8807
900	274	0.139	207	0.626	15.9	2326	10346	1564	6957	2.7	2299	10226
1000	305	0.139	207	0.626	15.9	2706	12037	1739	7735	2.7	2577	11463
1100	335	0.139	207	0.626	15.9	2833	12601	1913	8509	2.7	2809	12495
1200	366	0.139	207	0.626	15.9	3086	13728	2088	9288	2.7	3064	13629
1300	396	0.139	207	0.626	15.9	3340	14856	2262	10062	2.7	3319	14764
1400	427	0.139	207	0.626	15.9	3593	15983	2437	10840	2.7	3574	15898
1500	457	0.146	217	0.642	16.3	3973	17674	2737	12175	2.7	3952	17579
108 FIBERS												
100	30	0.170	254	0.685	17.4	2070	9207	213	947	1.8	436	1939
200	61	0.170	254	0.685	17.4	2070	9207	426	1895	2.0	748	3327
300	91	0.170	254	0.685	17.4	2070	9207	639	2842	2.2	1030	4582
400	122	0.170	254	0.685	17.4	2070	9207	852	3790	2.4	1297	5769
500	152	0.170	254	0.685	17.4	2070	9207	1065	4737	2.5	1554	6913
600	183	0.170	254	0.685	17.4	2070	9207	1278	5685	2.5	1805	8029
700	213	0.170	254	0.685	17.4	2070	9207	1491	6632	2.6	2050	9119
800	244	0.170	254	0.685	17.4	2340	10408	1704	7580	2.6	2339	10404
900	274	0.178	265	0.701	17.8	2720	12099	2000	8896	2.6	2713	12068
1000	305	0.178	265	0.701	17.8	3100	13790	2225	9897	2.6	3029	13474
1100	335	0.178	265	0.701	17.8	3354	14918	2448	10889	2.6	3323	14781
1200	366	0.178	265	0.701	17.8	3734	16609	2671	11881	2.6	3638	16183
1300	396	0.178	265	0.701	17.8	3987	17736	2894	12873	2.6	3933	17495
1400	427	0.186	276	0.717	18.2	4367	19427	3248	14448	2.6	4355	19372
1500	457	0.186	276	0.717	18.2	4748	21118	3481	15484	2.6	4678	20809

* Initial tension indicates tension before 10 year creep.

continued
→

All-Dielectric Self-Supporting (AFL-ADSS®) Fiber Optic Cable

Fiber Optic Cable

M E D I U M												
NESC MEDIUM LOADING @ 1% INSTALLATION SAG												
SPAN		WEIGHT		DIAMETER		MRCL		INITIAL TENSION				
FEET	METERS	LBS/FT	KG/KM	INCHES	MM	LBS	N	UNLOADED		LOADED		
								LBS	N	SAG %	LBS	N
120 FIBERS												
100	30	0.171	255	0.685	17.4	2070	9207	214	952	1.8	437	1944
200	61	0.171	255	0.685	17.4	2070	9207	429	1908	2.0	749	3332
300	91	0.171	255	0.685	17.4	2070	9207	643	2860	2.2	1033	4595
400	122	0.171	255	0.685	17.4	2070	9207	857	3812	2.4	1301	5787
500	152	0.171	255	0.685	17.4	2070	9207	1072	4768	2.5	1559	6935
600	183	0.171	255	0.685	17.4	2070	9207	1286	5720	2.5	1810	8051
700	213	0.171	255	0.685	17.4	2070	9207	1501	6677	2.6	2057	9150
800	244	0.179	266	0.701	17.8	2467	10972	1788	7953	2.6	2427	10796
900	274	0.179	266	0.701	17.8	2783	12381	2012	8950	2.6	2732	12153
1000	305	0.179	266	0.701	17.8	3100	13790	2238	9955	2.6	3039	13518
1100	335	0.179	267	0.701	17.8	3354	14918	2463	10956	2.6	3334	14830
1200	366	0.179	267	0.701	17.8	3734	16609	2687	11952	2.6	3650	16236
1300	396	0.179	267	0.701	17.8	4114	18300	2912	12953	2.6	3966	17642
1400	427	0.187	278	0.717	18.2	4621	20554	3267	14532	2.5	4409	19612
1500	457	0.187	278	0.717	18.2	4748	21118	3501	15573	2.6	4693	20876
132 FIBERS												
100	30	0.208	310	0.764	19.4	2070	9207	260	1157	1.8	476	2117
200	61	0.208	310	0.764	19.4	2070	9207	520	2313	2.1	826	3674
300	91	0.208	310	0.764	19.4	2070	9207	780	3470	2.2	1146	5098
400	122	0.208	310	0.764	19.4	2070	9207	1040	4626	2.3	1451	6454
500	152	0.208	310	0.764	19.4	2070	9207	1300	5783	2.4	1748	7775
600	183	0.208	310	0.764	19.4	2070	9207	1560	6939	2.5	2038	9065
700	213	0.208	310	0.764	19.4	2467	10972	1821	8100	2.5	2386	10613
800	244	0.208	310	0.764	19.4	2720	12099	2081	9257	2.5	2712	12064
900	274	0.216	322	0.780	19.8	3227	14354	2433	10823	2.5	3153	14025
1000	305	0.216	322	0.780	19.8	3607	16045	2704	12028	2.5	3507	15600
1100	335	0.217	322	0.780	19.8	3860	17172	2978	13247	2.5	3844	17099
1200	366	0.217	322	0.780	19.8	4241	18863	3249	14452	2.5	4198	18674
1300	396	0.217	322	0.780	19.8	4621	20554	3521	15662	2.5	4553	20253
1400	427	0.217	323	0.780	19.8	5001	22246	3793	16872	2.5	4908	21832
1500	457	0.225	335	0.795	20.2	5508	24500	4220	18771	2.4	5411	24069
144 FIBERS												
100	30	0.209	311	0.764	19.4	2070	9207	261	1161	1.8	477	2122
200	61	0.209	311	0.764	19.4	2070	9207	523	2326	2.1	827	3679
300	91	0.209	311	0.764	19.4	2070	9207	784	3487	2.2	1149	5111
400	122	0.209	311	0.764	19.4	2070	9207	1046	4653	2.3	1455	6472
500	152	0.209	311	0.764	19.4	2070	9207	1307	5814	2.4	1753	7798
600	183	0.209	311	0.764	19.4	2070	9207	1568	6975	2.5	2044	9092
700	213	0.209	311	0.764	19.4	2467	10972	1830	8140	2.5	2393	10645
800	244	0.209	311	0.764	19.4	2783	12381	2093	9310	2.5	2730	12144
900	274	0.217	324	0.780	19.8	3227	14354	2446	10880	2.5	3162	14065
1000	305	0.217	324	0.780	19.8	3607	16045	2718	12090	2.5	3517	15644
1100	335	0.218	324	0.780	19.8	3860	17172	2993	13314	2.5	3855	17148
1200	366	0.218	324	0.780	19.8	4241	18863	3266	14528	2.5	4211	18731
1300	396	0.218	324	0.780	19.8	4621	20554	3539	15742	2.5	4566	20311
1400	427	0.218	324	0.780	19.8	5001	22246	3812	16957	2.5	4922	21894
1500	457	0.226	337	0.795	20.2	5508	24500	4241	18865	2.4	5427	24140

* Initial tension indicates tension before 10 year creep.

continued
→



All-Dielectric Self-Supporting (AFL-ADSS®) Fiber Optic Cable

NEC MEDIUM LOADING @ 1% INSTALLATION SAG												
SPAN		WEIGHT		DIAMETER		MRCL		INITIAL TENSION				
FEET	METERS	LBS/FT	KG/KM	INCHES	MM	LBS	N	UNLOADED		LOADED		
								LBS	N	SAG %	LBS	N
216 FIBERS												
100	30	0.202	301	0.780	19.8	854	3797	253	1125	2.1	394	1753
200	61	0.202	301	0.780	19.8	854	3797	505	2246	2.4	694	3087
300	91	0.202	301	0.780	19.8	1002	4455	758	3372	2.5	1000	4448
400	122	0.202	301	0.780	19.8	1377	6125	1011	4497	2.5	1341	5965
500	152	0.202	301	0.780	19.8	1884	8380	1264	5623	2.5	1701	7566
600	183	0.202	301	0.780	19.8	2011	8943	1518	6752	2.5	2003	8910
700	213	0.211	313	0.795	20.2	2517	11198	1843	8198	2.5	2423	10778
800	244	0.211	314	0.795	20.2	2771	12326	2107	9372	2.5	2754	12250
900	274	0.211	314	0.795	20.2	3151	14017	2371	10547	2.5	3104	13807
1000	305	0.211	314	0.795	20.2	3658	16271	2636	11726	2.5	3473	15449
1100	335	0.211	314	0.795	20.2	3785	16835	2899	12895	2.5	3784	16832
1200	366	0.219	326	0.811	20.6	4292	19090	3290	14635	2.5	4259	18945
1300	396	0.220	327	0.811	20.6	4689	20857	3570	15880	2.5	4624	20569
1400	427	0.220	327	0.811	20.6	5069	22548	3846	17108	2.5	4984	22170
1500	457	0.220	327	0.811	20.6	5576	24803	4125	18349	2.5	5364	23860
288 FIBERS												
100	30	0.259	385	0.890	22.6	1296	5763	323	1439	2.0	488	2172
200	61	0.259	385	0.890	22.6	1296	5763	647	2878	2.2	866	3851
300	91	0.259	385	0.890	22.6	1296	5763	970	4317	2.4	1222	5437
400	122	0.259	385	0.890	22.6	1692	7528	1294	5757	2.4	1625	7229
500	152	0.259	385	0.890	22.6	2072	9219	1618	7198	2.4	2026	9013
600	183	0.259	385	0.890	22.6	2579	11474	1943	8641	2.4	2444	10872
700	213	0.259	386	0.890	22.6	2833	12601	2267	10083	2.4	2828	12580
800	244	0.259	386	0.890	22.6	3340	14856	2593	11534	2.4	3248	14447
900	274	0.269	400	0.906	23.0	3847	17111	3024	13450	2.4	3757	16710
1000	305	0.269	400	0.906	23.0	4227	18802	3360	14948	2.4	4168	18542
1100	335	0.269	400	0.906	23.0	4734	21056	3698	16448	2.4	4597	20450
1200	366	0.268	399	0.921	23.4	5069	22548	4019	17879	2.4	5002	22252
1300	396	0.268	399	0.921	23.4	5449	24239	4355	19373	2.4	5415	24085
1400	427	0.268	399	0.921	23.4	5829	25930	4692	20869	2.4	5827	25918
1500	457	0.267	397	0.921	23.4	6336	28185	5005	22265	2.4	6239	27750
432 FIBERS												
100	30	0.298	444	0.953	24.2	1296	5763	373	1658	2.0	529	2355
200	61	0.298	444	0.953	24.2	1296	5763	745	3316	2.2	949	4221
300	91	0.298	444	0.953	24.2	1384	6158	1118	4974	2.3	1360	6050
400	122	0.298	444	0.953	24.2	1819	8091	1491	6634	2.3	1811	8054
500	152	0.298	444	0.953	24.2	2326	10346	1865	8295	2.3	2270	10098
600	183	0.298	444	0.953	24.2	2833	12601	2238	9957	2.3	2730	12143
700	213	0.299	444	0.953	24.2	3340	14856	2612	11620	2.3	3190	14188
800	244	0.309	459	0.969	24.6	3973	17674	3087	13732	2.3	3752	16689
900	274	0.309	459	0.969	24.6	4227	18802	3473	15451	2.3	4192	18648
1000	305	0.309	460	0.969	24.6	4734	21056	3861	17172	2.3	4663	20744
1100	335	0.320	476	0.984	25.0	5322	23675	4396	19554	2.3	5273	23456
1200	366	0.320	476	0.984	25.0	5829	25930	4797	21338	2.3	5756	25605
1300	396	0.319	474	0.984	25.0	6336	28185	5178	23032	2.3	6223	27683
1400	427	0.319	474	0.984	25.0	6716	29876	5577	24809	2.3	6690	29760
1500	457	0.319	474	0.984	25.0	7223	32131	5977	26589	2.3	7173	31906

M E D I U M

Fiber Optic Cable

* Initial tension indicates tension before 10 year creep.

continued
→

All-Dielectric Self-Supporting (AFL-ADSS®) Fiber Optic Cable

NECS HEAVY LOADING @ 1% INSTALLATION SAG

SPAN		WEIGHT		DIAMETER		MRCL		INITIAL TENSION				
FEET	METERS	LBS/FT	KG/KM	INCHES	MM	LBS	N	UNLOADED		LOADED		
								LBS	N	SAG %	LBS	N
12 FIBERS												
100	30	0.080	119	0.500	12.7	539	2398	100	446	3.5	335	1492
200	61	0.080	119	0.500	12.7	598	2661	201	892	4.1	569	2533
300	91	0.080	119	0.500	12.7	936	4162	301	1339	4.1	864	3844
400	122	0.084	125	0.512	13.0	1189	5290	421	1875	4.2	1152	5125
500	152	0.084	126	0.512	13.0	1506	6699	527	2345	4.1	1445	6429
600	183	0.085	126	0.512	13.0	1823	8108	634	2821	4.1	1739	7737
700	213	0.090	134	0.528	13.4	2076	9236	788	3503	4.1	2052	9127
800	244	0.090	134	0.528	13.4	2456	10927	901	4006	4.1	2367	10530
900	274	0.090	134	0.528	13.4	2710	12054	1014	4509	4.1	2649	11785
1000	305	0.090	134	0.528	13.4	2963	13182	1127	5012	4.1	2931	13040
1100	335	0.093	138	0.535	13.6	3344	14873	1278	5687	4.1	3276	14572
1200	366	0.093	138	0.535	13.6	3597	16000	1395	6207	4.1	3561	15839
1300	396	0.102	151	0.559	14.2	4104	18255	1652	7349	4.1	4017	17869
1400	427	0.102	152	0.559	14.2	4309	19166	1783	7933	4.1	4300	19125
1500	457	0.102	152	0.559	14.2	4689	20857	1915	8517	4.1	4628	20585
24 FIBERS												
100	30	0.081	121	0.500	12.7	539	2398	102	452	3.5	336	1495
200	61	0.081	121	0.500	12.7	598	2661	203	904	4.1	571	2539
300	91	0.081	121	0.500	12.7	936	4162	305	1357	4.1	866	3853
400	122	0.085	127	0.512	13.0	1189	5290	427	1898	4.1	1155	5137
500	152	0.085	127	0.512	13.0	1506	6699	534	2374	4.1	1449	6445
600	183	0.086	127	0.512	13.0	1823	8108	642	2856	4.1	1743	7755
700	213	0.091	136	0.528	13.4	2076	9236	797	3545	4.1	2057	9149
800	244	0.091	136	0.528	13.4	2456	10927	911	4054	4.1	2373	10555
900	274	0.091	136	0.528	13.4	2837	12618	1026	4563	4.1	2689	11960
1000	305	0.091	136	0.528	13.4	2963	13182	1140	5071	4.1	2938	13071
1100	335	0.094	140	0.535	13.6	3344	14873	1293	5752	4.1	3284	14606
1200	366	0.094	140	0.535	13.6	3724	16564	1411	6278	4.1	3602	16025
1300	396	0.103	153	0.559	14.2	4231	18819	1670	7427	4.0	4059	18055
1400	427	0.103	153	0.559	14.2	4435	19729	1802	8017	4.1	4343	19317
1500	457	0.103	154	0.559	14.2	4689	20857	1935	8605	4.1	4638	20633
36 FIBERS												
100	30	0.082	123	0.500	12.7	539	2398	103	458	3.5	337	1499
200	61	0.082	123	0.500	12.7	598	2661	206	916	4.1	572	2544
300	91	0.082	123	0.500	12.7	936	4162	309	1375	4.1	868	3861
400	122	0.086	129	0.512	13.0	1189	5290	432	1922	4.1	1158	5151
500	152	0.086	129	0.512	13.0	1506	6699	540	2402	4.1	1452	6459
600	183	0.087	129	0.512	13.0	1823	8108	650	2891	4.1	1748	7775
700	213	0.092	137	0.528	13.4	2076	9236	806	3585	4.1	2062	9172
800	244	0.092	137	0.528	13.4	2456	10927	922	4101	4.1	2379	10582
900	274	0.092	137	0.528	13.4	2710	12054	1038	4617	4.1	2662	11841
1000	305	0.092	137	0.528	13.4	3090	13745	1154	5133	4.1	2979	13251
1100	335	0.095	142	0.535	13.6	3470	15436	1308	5818	4.1	3324	14786
1200	366	0.095	142	0.535	13.6	3597	16000	1427	6348	4.1	3578	15916
1300	396	0.104	154	0.559	14.2	4104	18255	1687	7504	4.1	4036	17953
1400	427	0.104	155	0.559	14.2	4435	19729	1821	8100	4.1	4353	19363
1500	457	0.104	155	0.559	14.2	4689	20857	1954	8692	4.1	4649	20680

* Initial tension indicates tension before 10 year creep.

continued
→



All-Dielectric Self-Supporting (AFL-ADSS®) Fiber Optic Cable

NESC HEAVY LOADING @ 1% INSTALLATION SAG												
SPAN		WEIGHT		DIAMETER		MRCL		INITIAL TENSION				
FEET	METERS	LBS/FT	KG/KM	INCHES	MM	LBS	N	UNLOADED		LOADED		
								LBS	N	SAG %	LBS	N
48 FIBERS												
100	30	0.083	124	0.500	12.7	539	2398	104	463	3.5	338	1503
200	61	0.083	124	0.500	12.7	598	2661	209	930	4.1	574	2553
300	91	0.083	124	0.500	12.7	936	4162	313	1392	4.1	870	3870
400	122	0.087	130	0.512	13.0	1189	5290	437	1944	4.1	1160	5160
500	152	0.088	130	0.512	13.0	1506	6699	547	2433	4.1	1456	6477
600	183	0.088	131	0.512	13.0	1823	8108	658	2927	4.1	1752	7793
700	213	0.093	139	0.528	13.4	2076	9236	815	3625	4.1	2067	9194
800	244	0.093	139	0.528	13.4	2456	10927	932	4146	4.1	2384	10605
900	274	0.093	139	0.528	13.4	2710	12054	1049	4666	4.1	2668	11868
1000	305	0.093	139	0.528	13.4	3090	13745	1167	5191	4.1	2986	13282
1100	335	0.096	143	0.535	13.6	3470	15436	1322	5881	4.1	3332	14821
1200	366	0.096	143	0.535	13.6	3724	16564	1443	6419	4.1	3620	16103
1300	396	0.105	156	0.559	14.2	4104	18255	1704	7580	4.1	4045	17993
1400	427	0.105	156	0.559	14.2	4435	19729	1839	8180	4.1	4363	19408
1500	457	0.105	157	0.559	14.2	4689	20857	1974	8781	4.1	4660	20729
60 FIBERS												
100	30	0.084	126	0.500	12.7	539	2398	106	472	3.5	338	1503
200	61	0.084	126	0.500	12.7	598	2661	211	939	4.1	575	2558
300	91	0.085	126	0.500	12.7	936	4162	317	1410	4.1	872	3879
400	122	0.089	132	0.512	13.0	1189	5290	443	1971	4.1	1163	5173
500	152	0.089	132	0.512	13.0	1569	6981	554	2464	4.1	1476	6566
600	183	0.089	132	0.512	13.0	1823	8108	666	2963	4.1	1756	7811
700	213	0.094	140	0.528	13.4	2076	9236	825	3670	4.1	2072	9217
800	244	0.094	140	0.528	13.4	2456	10927	943	4195	4.1	2390	10631
900	274	0.094	140	0.528	13.4	2710	12054	1061	4720	4.1	2675	11899
1000	305	0.094	140	0.528	13.4	2963	13182	1180	5249	4.1	2960	13167
1100	335	0.097	145	0.535	13.6	3344	14873	1337	5947	4.1	3307	14710
1200	366	0.097	145	0.535	13.6	3597	16000	1459	6490	4.1	3595	15991
1300	396	0.106	158	0.559	14.2	4104	18255	1721	7655	4.1	4055	18038
1400	427	0.106	158	0.559	14.2	4435	19729	1858	8265	4.0	4373	19452
1500	457	0.106	158	0.559	14.2	4689	20857	1994	8870	4.1	4671	20778
72 FIBERS												
100	30	0.100	148	0.535	13.6	854	3797	125	556	3.1	400	1779
200	61	0.100	148	0.535	13.6	854	3797	249	1108	3.7	662	2945
300	91	0.100	148	0.535	13.6	913	4060	374	1664	4.1	907	4035
400	122	0.108	161	0.559	14.2	1314	5843	542	2411	4.0	1267	5636
500	152	0.108	161	0.559	14.2	1567	6970	678	3016	4.0	1565	6961
600	183	0.108	161	0.559	14.2	1884	8380	814	3621	4.0	1879	8358
700	213	0.109	162	0.559	14.2	2264	10071	950	4226	4.0	2210	9831
800	244	0.109	162	0.559	14.2	2644	11762	1088	4840	4.0	2541	11303
900	274	0.109	162	0.559	14.2	2898	12889	1224	5445	4.0	2839	12629
1000	305	0.109	162	0.559	14.2	3151	14017	1361	6054	4.0	3138	13959
1100	335	0.115	171	0.575	14.6	3531	15708	1579	7024	4.0	3531	15707
1200	366	0.115	171	0.575	14.6	3911	17399	1723	7664	4.0	3867	17201
1300	396	0.115	171	0.575	14.6	4292	19090	1870	8318	4.0	4205	18705
1400	427	0.115	171	0.575	14.6	4545	20217	2015	8963	4.0	4509	20057
1500	457	0.123	183	0.594	15.1	5069	22548	2308	10266	3.9	4994	22214

* Initial tension indicates tension before 10 year creep.

continued
→



All-Dielectric Self-Supporting (AFL-ADSS®) Fiber Optic Cable

NECS HEAVY LOADING @ 1% INSTALLATION SAG

SPAN		WEIGHT		DIAMETER		MRCL		INITIAL TENSION				
FEET	METERS	LBS/FT	KG/KM	INCHES	MM	LBS	N	UNLOADED		LOADED		
								LBS	N	SAG %	LBS	N
84 FIBERS												
100	30	0.131	195	0.610	15.5	1296	5763	164	730	2.8	483	2148
200	61	0.131	195	0.610	15.5	1296	5763	328	1459	3.3	803	3572
300	91	0.131	195	0.610	15.5	1296	5763	492	2189	3.7	1085	4826
400	122	0.131	195	0.610	15.5	1384	6158	656	2918	3.9	1369	6090
500	152	0.131	195	0.610	15.5	1756	7810	821	3652	3.9	1718	7642
600	183	0.131	195	0.610	15.5	2072	9219	985	4381	3.9	2053	9132
700	213	0.138	205	0.626	15.9	2453	10910	1208	5373	3.9	2448	10889
800	244	0.138	205	0.626	15.9	2833	12601	1381	6143	3.9	2806	12482
900	274	0.138	206	0.626	15.9	3213	14292	1554	6913	3.9	3163	14070
1000	305	0.138	206	0.626	15.9	3593	15983	1727	7682	3.9	3521	15662
1100	335	0.145	216	0.642	16.3	3973	17674	1992	8861	3.9	3948	17562
1200	366	0.145	216	0.642	16.3	4354	19365	2174	9670	3.8	4312	19181
1300	396	0.145	216	0.642	16.3	4734	21056	2356	10480	3.8	4676	20800
1400	427	0.148	220	0.661	16.8	5196	23112	2587	11508	3.8	5115	22753
1500	457	0.148	220	0.661	16.8	5576	24803	2773	12335	3.8	5483	24390
96 FIBERS												
100	30	0.132	197	0.610	15.5	1296	5763	165	734	2.8	483	2148
200	61	0.132	197	0.610	15.5	1296	5763	331	1472	3.3	805	3581
300	91	0.132	197	0.610	15.5	1296	5763	496	2206	3.7	1088	4840
400	122	0.132	197	0.610	15.5	1384	6158	662	2945	3.9	1372	6103
500	152	0.132	197	0.610	15.5	1756	7810	827	3679	3.9	1722	7660
600	183	0.132	197	0.610	15.5	2072	9219	993	4417	3.9	2058	9154
700	213	0.139	207	0.626	15.9	2579	11474	1217	5413	3.8	2484	11049
800	244	0.139	207	0.626	15.9	2833	12601	1391	6187	3.9	2812	12508
900	274	0.139	207	0.626	15.9	3213	14292	1566	6966	3.9	3170	14101
1000	305	0.139	207	0.626	15.9	3593	15983	1741	7744	3.9	3528	15693
1100	335	0.146	217	0.642	16.3	3973	17674	2007	8928	3.8	3957	17602
1200	366	0.146	217	0.642	16.3	4480	19929	2191	9746	3.8	4352	19359
1300	396	0.146	217	0.642	16.3	4734	21056	2374	10560	3.8	4686	20844
1400	427	0.149	222	0.661	16.8	5196	23112	2606	11592	3.8	5126	22802
1500	457	0.149	222	0.661	16.8	5576	24803	2793	12424	3.8	5495	24443
108 FIBERS												
100	30	0.170	254	0.685	17.4	2070	9207	213	947	2.5	589	2620
200	61	0.170	254	0.685	17.4	2070	9207	426	1895	2.9	986	4386
300	91	0.170	254	0.685	17.4	2070	9207	639	2842	3.3	1337	5947
400	122	0.170	254	0.685	17.4	2070	9207	852	3790	3.5	1662	7393
500	152	0.170	254	0.685	17.4	2070	9207	1065	4737	3.7	1972	8772
600	183	0.170	254	0.685	17.4	2340	10408	1278	5685	3.7	2334	10382
700	213	0.178	265	0.701	17.8	2847	12663	1556	6921	3.7	2799	12451
800	244	0.178	265	0.701	17.8	3227	14354	1780	7918	3.7	3195	14212
900	274	0.178	265	0.701	17.8	3607	16045	2003	8910	3.7	3589	15965
1000	305	0.178	265	0.701	17.8	3987	17736	2226	9902	3.7	3984	17722
1100	335	0.186	276	0.717	18.2	4494	19991	2552	11352	3.7	4487	19959
1200	366	0.186	276	0.717	18.2	5001	22246	2785	12388	3.7	4917	21872
1300	396	0.186	276	0.717	18.2	5381	23937	3019	13429	3.7	5320	23665
1400	427	0.186	277	0.717	18.2	5761	25628	3252	14466	3.7	5722	25453
1500	457	0.188	279	0.748	19.0	6336	28185	3518	15649	3.7	6235	27735

* Initial tension indicates tension before 10 year creep.

continued
→



All-Dielectric Self-Supporting (AFL-ADSS®) Fiber Optic Cable

NEC HEAVY LOADING @ 1% INSTALLATION SAG												
SPAN		WEIGHT		DIAMETER		MRCL		INITIAL TENSION				
FEET	METERS	LBS/FT	KG/KM	INCHES	MM	LBS	N	UNLOADED		LOADED		
								LBS	N	SAG %	LBS	N
120 FIBERS												
100	30	0.171	255	0.685	17.4	2070	9207	214	952	2.5	590	2624
200	61	0.171	255	0.685	17.4	2070	9207	429	1908	2.9	988	4395
300	91	0.171	255	0.685	17.4	2070	9207	643	2860	3.3	1339	5956
400	122	0.171	255	0.685	17.4	2070	9207	857	3812	3.5	1666	7411
500	152	0.171	255	0.685	17.4	2070	9207	1072	4768	3.7	1976	8790
600	183	0.172	255	0.685	17.4	2340	10408	1287	5725	3.7	2339	10404
700	213	0.179	266	0.701	17.8	2847	12663	1565	6961	3.7	2805	12477
800	244	0.179	266	0.701	17.8	3227	14354	1791	7967	3.7	3201	14239
900	274	0.179	267	0.701	17.8	3607	16045	2015	8963	3.7	3597	16000
1000	305	0.179	267	0.701	17.8	4114	18300	2240	9964	3.7	4021	17886
1100	335	0.187	278	0.717	18.2	4621	20554	2567	11419	3.6	4524	20124
1200	366	0.187	278	0.717	18.2	5001	22246	2802	12464	3.6	4928	21921
1300	396	0.187	278	0.717	18.2	5381	23937	3036	13505	3.7	5331	23713
1400	427	0.187	278	0.717	18.2	5761	25628	3271	14550	3.7	5734	25506
1500	457	0.189	281	0.748	19.0	6336	28185	3539	15742	3.7	6247	27788
132 FIBERS												
100	30	0.208	310	0.764	19.4	2070	9207	260	1157	2.5	631	2807
200	61	0.208	310	0.764	19.4	2070	9207	520	2313	2.9	1064	4733
300	91	0.208	310	0.764	19.4	2070	9207	780	3470	3.2	1450	6450
400	122	0.208	310	0.764	19.4	2070	9207	1040	4626	3.5	1811	8056
500	152	0.208	310	0.764	19.4	2188	9734	1300	5783	3.6	2183	9710
600	183	0.208	310	0.764	19.4	2657	11817	1561	6944	3.6	2626	11681
700	213	0.216	322	0.780	19.8	3227	14354	1893	8420	3.5	3147	13999
800	244	0.216	322	0.780	19.8	3607	16045	2164	9626	3.5	3580	15925
900	274	0.217	322	0.780	19.8	4114	18300	2437	10840	3.5	4041	17975
1000	305	0.217	322	0.780	19.8	4494	19991	2708	12046	3.5	4474	19901
1100	335	0.217	323	0.780	19.8	5001	22246	2980	13256	3.5	4935	21952
1200	366	0.225	335	0.795	20.2	5508	24500	3376	15017	3.5	5493	24434
1300	396	0.221	328	0.811	20.6	5956	26494	3584	15942	3.5	5921	26338
1400	427	0.220	327	0.811	20.6	6463	28749	3844	17099	3.5	6377	28366
1500	457	0.220	327	0.811	20.6	6843	30440	4120	18327	3.6	6816	30319
144 FIBERS												
100	30	0.209	311	0.764	19.4	2070	9207	261	1161	2.5	632	2811
200	61	0.209	311	0.764	19.4	2070	9207	523	2326	2.9	1065	4737
300	91	0.209	311	0.764	19.4	2070	9207	784	3487	3.2	1452	6459
400	122	0.209	311	0.764	19.4	2070	9207	1046	4653	3.4	1815	8074
500	152	0.209	311	0.764	19.4	2188	9734	1307	5814	3.6	2187	9728
600	183	0.209	311	0.764	19.4	2657	11817	1569	6979	3.6	2631	11703
700	213	0.217	324	0.780	19.8	3227	14354	1902	8461	3.5	3153	14025
800	244	0.217	324	0.780	19.8	3607	16045	2175	9675	3.5	3587	15956
900	274	0.218	324	0.780	19.8	4114	18300	2449	10894	3.5	4049	18011
1000	305	0.218	324	0.780	19.8	4494	19991	2722	12108	3.5	4483	19941
1100	335	0.218	324	0.780	19.8	5001	22246	2995	13322	3.5	4944	21992
1200	366	0.226	337	0.795	20.2	5508	24500	3392	15088	3.5	5504	24483
1300	396	0.222	330	0.811	20.6	6083	27057	3602	16022	3.5	5960	26511
1400	427	0.221	329	0.811	20.6	6463	28749	3863	17183	3.5	6389	28420
1500	457	0.221	329	0.811	20.6	6843	30440	4141	18420	3.6	6829	30377

* Initial tension indicates tension before 10 year creep.

continued
→



All-Dielectric Self-Supporting (AFL-ADSS®) Fiber Optic Cable

NEC HEAVY LOADING @ 1% INSTALLATION SAG

SPAN		WEIGHT		DIAMETER		MRCL		INITIAL TENSION				
FEET	METERS	LBS/FT	KG/KM	INCHES	MM	LBS	N	UNLOADED		LOADED		
								LBS	N	SAG %	LBS	N
216 FIBERS												
100	30	0.202	301	0.780	19.8	854	3797	253	1125	3.1	505	2246
200	61	0.202	301	0.780	19.8	913	4060	505	2246	3.6	875	3892
300	91	0.202	301	0.780	19.8	1314	5843	758	3372	3.6	1300	5783
400	122	0.202	301	0.780	19.8	1884	8380	1012	4502	3.6	1762	7838
500	152	0.211	313	0.795	20.2	2264	10071	1316	5854	3.6	2224	9893
600	183	0.211	314	0.795	20.2	2771	12326	1580	7028	3.6	2681	11926
700	213	0.211	314	0.795	20.2	3151	14017	1844	8203	3.6	3111	13838
800	244	0.211	314	0.795	20.2	3658	16271	2108	9377	3.6	3568	15871
900	274	0.211	314	0.795	20.2	4038	17963	2373	10556	3.6	3998	17784
1000	305	0.219	326	0.811	20.6	4545	20217	2742	12197	3.6	4538	20186
1100	335	0.220	327	0.811	20.6	5069	22548	3022	13443	3.5	5010	22286
1200	366	0.220	327	0.811	20.6	5576	24803	3300	14679	3.5	5477	24363
1300	396	0.229	340	0.827	21.0	6083	27057	3716	16530	3.5	6053	26925
1400	427	0.228	339	0.827	21.0	6590	29312	3983	17717	3.5	6515	28980
1500	457	0.228	339	0.827	21.0	6970	31003	4269	18989	3.5	6962	30969
288 FIBERS												
100	30	0.259	385	0.890	22.6	1296	5763	323	1439	2.8	619	2753
200	61	0.259	385	0.890	22.6	1296	5763	647	2878	3.3	1061	4720
300	91	0.259	385	0.890	22.6	1566	6964	971	4317	3.4	1522	6771
400	122	0.259	385	0.890	22.6	2072	9219	1295	5759	3.4	2027	9016
500	152	0.259	385	0.890	22.6	2579	11474	1619	7201	3.4	2532	11262
600	183	0.259	386	0.890	22.6	3086	13728	1943	8644	3.4	3037	13509
700	213	0.269	400	0.906	23.0	3720	16547	2351	10460	3.4	3633	16163
800	244	0.269	400	0.906	23.0	4227	18802	2688	11958	3.4	4148	18453
900	274	0.269	400	0.906	23.0	4734	21056	3025	13457	3.4	4663	20744
1000	305	0.268	399	0.921	23.4	5196	23112	3350	14900	3.4	5176	23026
1100	335	0.268	399	0.921	23.4	5703	25366	3686	16396	3.4	5692	25321
1200	366	0.268	399	0.921	23.4	6209	27621	4022	17892	3.4	6208	27616
1300	396	0.267	397	0.921	23.4	6716	29876	4339	19301	3.4	6711	29854
1400	427	0.277	412	0.937	23.8	7477	33258	4845	21552	3.4	7412	32972
1500	457	0.277	412	0.937	23.8	7984	35513	5193	23098	3.4	7938	35308
432 FIBERS												
100	30	0.298	444	0.953	24.2	1296	5763	373	1658	2.8	659	2931
200	61	0.298	444	0.953	24.2	1296	5763	745	3316	3.2	1140	5070
300	91	0.298	444	0.953	24.2	1692	7528	1118	4975	3.3	1665	7405
400	122	0.298	444	0.953	24.2	2326	10346	1492	6636	3.3	2233	9932
500	152	0.298	444	0.953	24.2	2833	12601	1865	8298	3.3	2778	12356
600	183	0.299	444	0.953	24.2	3340	14856	2239	9960	3.3	3322	14779
700	213	0.309	459	0.969	24.6	3973	17674	2701	12015	3.3	3962	17625
800	244	0.309	460	0.969	24.6	4607	20493	3088	13737	3.3	4541	20202
900	274	0.320	476	0.984	25.0	5322	23675	3597	15999	3.2	5233	23279
1000	305	0.320	476	0.984	25.0	5829	25930	3997	17781	3.2	5800	25800
1100	335	0.319	474	0.984	25.0	6463	28749	4382	19490	3.2	6379	28374
1200	366	0.319	474	0.984	25.0	6970	31003	4781	21268	3.3	6945	30891
1300	396	0.329	490	1.000	25.4	7730	34385	5350	23799	3.2	7695	34229
1400	427	0.329	490	1.000	25.4	8364	37204	5764	25639	3.2	8295	36899
1500	457	0.329	490	1.000	25.4	8997	40022	6178	27479	3.2	8896	39570

* Initial tension indicates tension before 10 year creep.

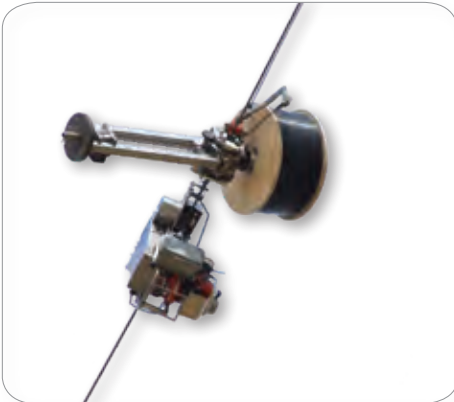

SkyWrap®

Successfully installed worldwide since 1982, SkyWrap is a fiber optic cable helically applied on ground wires or phase conductors. A specially designed spinning machine is used to wrap the cable under controlled conditions. This system offers a complete communication link designed and engineered for high-voltage environments at low cost.

SkyWrap is the ideal solution when access to the overhead line is problematic due to environment or terrain. The installation equipment is lightweight, easy to handle and quick to install. When power outages are hard to coordinate SkyWrap can be installed on ground wire while the phase conductors remain live, or on phase conductors with single circuit outage.

Features

- Suitable for use on distribution lines
- Gel-filled buffer tubes are S-Z stranded for easy mid-span access
- Design details listed below for span lengths up to 457 metres and fiber counts up to 144
- Requires the use of formed wire dead ends single circuit outage on phase
- Complete lifetime turn-key solutions
- Over 30 years installation experience

Benefits

- Quick, cost effective installation
- Utilise existing power line infrastructure
- Use where access is limited (e.g. mountains and river crossings)
- Use for both ground wires and phase conductors
- Live line installations on ground wire or single circuit outage on phase

Cable Components

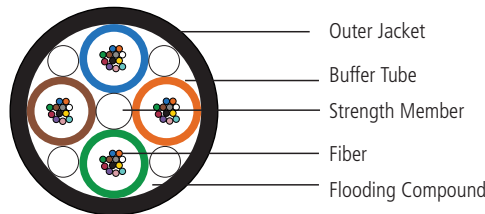

Temperature Specifications

TEMPERATURE RANGE	
OPERATING	-40°C to +85°C
STORAGE	-40°C to +50°C
INSTALLATION	-20°C to +50°C

continued
→

SkyWrap®

Part Number

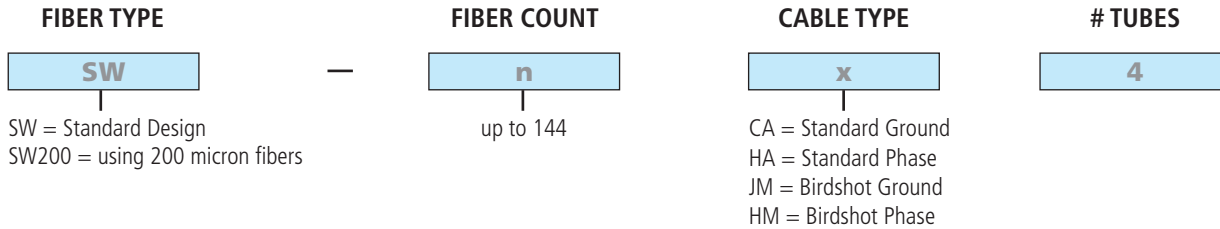

SkyWrap Ordering Information

ITEM NUMBER	FIBER COUNT	CABLE O.D.	WEIGHT	LENGTH PER REEL	CASSETTE LENGTH
		mm	km/kg	m	m
STANDARD GROUND WIRE					
SW-nCA4	04 - 24	6.4	36	2,440	4,880
SW-nCA4	26 - 48	6.6	39	2,295	4,590
SW-nCA4	50 - 96	8.0	59	1,562	3,124
BIRDSHOT RESISTANT GROUND WIRE					
SW-nJM4	04 - 24	7.3	46	1,826	3,652
SW-nJM4	26 - 48	7.5	50	1,730	3,460
SW-nJM4	50 - 96	8.9	71	1,228	2,456
SW200-nJM4	100-144	8.7	55	1,285	2,570
STANDARD PHASE CONDUCTOR					
SW-nHA4	04 - 24	7.3	55	1,914	3,828
SW-nHA4	26 - 48	7.5	59	1,813	3,626
SW-nHA4	50 - 96	8.9	82	1,288	2,576
BIRDSHOT RESISTANT PHASE CONDUCTOR					
SW-nHM4	04 - 24	8.0	61	1,594	3,188
SW-nHM4	26 - 48	8.2	65	1,517	3,034
SW-nHM4	50 - 96	9.6	89	1,107	2,214
SW200-nHM4	100-144	9.4	81	1,154	2,308

Note: Diameter and weight subject to change without notice

Installation Equipment Information

PARAMETER	VALUE
Typical Weight (includes cable and balance weight)	250 kg
Min-Max Radius of Rotation	0.87 - 1.45 m
Wrapping Speed	5 km per hour

Installation Hardware

A full range of hardware and accessories are available as part of the SkyWrap solution. Many different options are available to suit individual structure types and environmental conditions. Please contact AFL for more information.

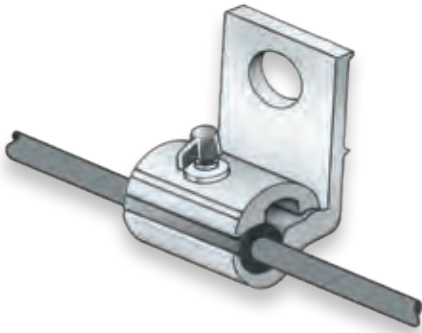

Mini-Bracket

Mini-Bracket

Mini Brackets are used for short and medium spans of ADSS fiber optic cable as well as Aerial Drop cables. Mini Brackets are sized to fit specific ADSS diameters. Standard Mini Brackets are employed with fitted bushings to provide a good support/groove fit and to prevent the support from damaging the cable. The bolted supports are supplied with aluminum captive bolts to simplify installation with no loose parts.

Features

- Maximum one side angle: 8.5 degrees
- Estimated weight: 2.9 lbs. (1.3 Kg)
- Maximum rated strength: 3,000 lbs.
- Hand tighten bolt to 25 in. lbs. (2.8 N-m)
- Slip load at 4 to 6% of RBS

Ordering Information

DESCRIPTION	AFL NO.
Aerial Drop 256 maximum line angle = 17° (150 ft NESC heavy, 275 ft NESC medium, 550 ft NESC light)	AMBB256
Aerial Drop 307 maximum line angle = 17° (220 ft NESC heavy, 400 ft NESC medium, 675 ft NESC light)	AMBB307
ADSS Mini-Span 424 maximum line angle = 17° (275 ft NESC heavy, 450 ft NESC medium, 600 ft NESC light)	AMBB424
ADSS Mini-Span 484 maximum line angle = 17° (275 ft NESC heavy, 400 ft NESC medium, 525 ft NESC light)	AMBB484-535
ADSS Mini-Span 535 maximum line angle = 17° (350 ft NESC heavy, 550 ft NESC medium, 675 ft NESC light)	AMBB484-535



ATS 321/330
ATS 371/383

Mini Formed Wire Tangent Support (FTS)

Formed Wire Tangent Supports (FTS) are used with ADSS Mini-Span® 323 and Mini-Span® 383 for short span applications. Tangent supports provide a method of attaching AFL's smallest ADSS Mini-Span designs with excellent unbalanced load capability and bend relief support. This product is designed to connect directly to J-hooks on wood poles for an economical solution.

Ordering Information

DESCRIPTION	AFL NO.
ADSS Mini-Span 323 maximum line angle = 20°(175 ft NESC heavy, 300 ft NESC medium, 500 ft NESC light)	ATS321/330
ADSS Mini-Span 383 maximum line angle = 20°(180 ft NESC heavy, 300 ft NESC medium, 450 ft NESC light)	ATS371/383



ADESDFW2-256 and 307



ADELD2E-323T and 383T



ADELD2E-424005TE
* shown with optional thimble eye

Mini-Dead Ends

The Mini-Dead Ends are designed for fast and easy installation of your ADSS Mini-Span® cable. The Mini-Dead End is ideal in crowded distribution environments where its shorter length allows for efficient installation. This unique low-cost product is used in typical spans with 1%-2% installation sag.

Features

- Easy and quick installation
- No special tools or hardware required for installation
- Small, requiring less storage space

Ordering Information

APPLICATION & DESCRIPTION	AFL NO.
Aerial Drop 256 150 ft NESC heavy, 275 ft NESC medium, 550 ft NESC light	ADESDFW2-256
Aerial Drop 307—Short Span (250 lb max. tension) 65 ft NESC heavy, 115 ft NESC medium, 210 ft NESC light	ADESDFW2-307
Aerial Drop 307—Long Span 220 ft NESC heavy, 400 ft NESC medium, 675 ft NESC light	ADELD2E-013TE
ADSS Mini-Span 323 175 ft NESC heavy, 300 ft NESC medium, 500 ft NESC light	ADELD2E-323T
ADSS Mini-Span 383 180 ft NESC heavy, 300 ft NESC medium, 450 ft NESC light	ADELD2E-383T
ADSS Mini-Span 424 275 ft NESC heavy, 450 ft NESC medium, 600 ft NESC light	ADELD2E-424005

NOTE: Part numbers ADEW10J1-AL535, and ADEW16J1-AL693 attach to structure via common pole hardware sold separately such as thimble eye, ram's head, guy hooks, etc.

For spans greater than the span lengths above, contact Customer Service.



Single Trunnion Cable Support



Double Trunnion Cable Support (closed)



Double Trunnion Cable Support (open)

Trunnion Assemblies— Single and Double Cables

AFL offers trunnions with various mounting capabilities: bolted, banded or standoff. Trunnions reduce installation costs by functioning as a pull-through during installation (maximum line angle for stringing is 15° total, 7.5° per side, number of structures not to exceed 30). No block or pulley is needed provided these conditions are met.

Features

- May be used as a pull-through by removing the bushing inserts
- Double cable supports option
- High-strength aluminum
- Smaller and more compact design
- Facilitates faster installation
- Color-coded range taking inserts for easy identification
- Versatile mounting styles to fit different structure types: bolted, banded or standoff
- Banding and pole hardware supplied by customer
- Lowers the total cost of installation
- Span Length: 600 ft.—NESC Heavy
1,200 ft.—NESC Light

Ordering Information—Single Cable Support

AFL NO.	CABLE O.D. RANGE		ESTIMATED WEIGHT		BUSHING COLOR CODE
	INCHES	MILLIMETERS	LBS	KG	
ATGN325/375	0.325" - 0.375"	8.26 - 9.53	2.06	.934	Green + White
ATGN376/419	0.376" - 0.419"	9.55 - 10.64	2.06	.934	Orange + White
ATGN420/474	0.420" - 0.474"	10.67 - 12.05	2.05	.930	Purple + White
ATGN475/525	0.475" - 0.525"	12.07 - 13.34	2.05	.930	Blue
ATGN526/575	0.526" - 0.575"	13.36 - 14.61	2.05	.930	Orange
ATGN576/625	0.576" - 0.625"	14.63 - 15.88	2.04	.925	Brown
ATGN626/675	0.626" - 0.675"	15.90 - 17.15	2.04	.925	Green
ATGN676/725	0.676" - 0.725"	17.17 - 18.42	2.03	.921	White
ATGN726/775	0.726" - 0.775"	18.44 - 19.69	2.03	.921	Red
ATGN776/825	0.776" - 0.825"	19.71 - 20.96	2.02	.916	Purple
ATGN826/875	0.826" - 0.875"	20.98 - 22.23	2.02	.916	Yellow
ATGN876/925	0.876" - 0.925"	22.25 - 23.50	2.02	.916	Pink
ATGN926/959	0.926" - 0.959"	23.52 - 24.36	2.02	.916	Blue + White
ATGN960/1045	0.960" - 1.045"	24.38 - 26.54	2.02	.916	Gray

Application Notes:

1. For use with ADSS cables with polyethylene jackets in low voltage environments only. Not for use in high voltage environments where tracking resistant cables are required.
2. As a stringing block:
Maximum line angle = 15° (7.5° per side)
Maximum number of structures = 30
3. For final installation:
Maximum line angle = 22° (11° per side)

continued
→

Trunnion Assemblies (cont.)

Ordering Information—Double Tangent Support

BUSHING NUMBER		CABLE O.D. RANGE		BUSHING COLOR CODE	MAXIMUM SPAN CAPABILITIES USING NESC LOADS IN FEET/METERS	ESTIMATED WEIGHT	
"A"	"B"	INCHES	MM			HEAVY	LBS
325	325	.325-.375	8.26-9.53	Green + White	600/182.9	4.00	1.814
376	376	.376-.419	9.55-10.64	Orange + White	600/182.9	4.00	1.814
420	420	.420-.474	10.67-12.04	Purple + White	600/182.9	3.99	1.810
475	475	.475-.525	12.07-13.34	Blue	600/182.9	3.99	1.810
526	526	.526-.575	13.36-14.61	Orange	600/182.9	3.99	1.810
576	576	.576-.625	14.63-15.88	Brown	600/182.9	3.98	1.805
626	626	.626-.675	15.90-17.15	Green	600/182.9	3.98	1.805
676	676	.676-.725	17.17-18.42	White	600/182.9	3.97	1.801
726	726	.726-.775	18.44-19.69	Red	600/182.9	3.97	1.801
776	776	.776-.825	19.71-20.96	Purple	600/182.9	3.96	1.796
826	826	.826-.875	20.98-22.23	Yellow	600/182.9	3.96	1.796
876	876	.876-.925	22.25-23.50	Pink	500/152.4	3.96	1.796
926	926	.926-.959	23.52-24.36	Blue + White	CONTACT AFL	3.96	1.796
960	960	.960-1.045	24.38-26.54	Gray	CONTACT AFL	3.96	1.796

How to Order

Order by assembling part number as shown:

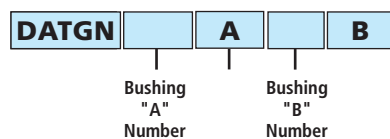

- Reference table above. See Note 1 below.
- Example:
 - First cable 0.500" OD → Bushing "A" number = 475
 - Second cable 0.750" OD → Bushing "B" number = 726
 - Order by part number: DATGN475A726B

Notes:

1. Bushing "A" and "B" may be the same or different.
2. Attachment hardware or stainless steel banding to be supplied by customer.

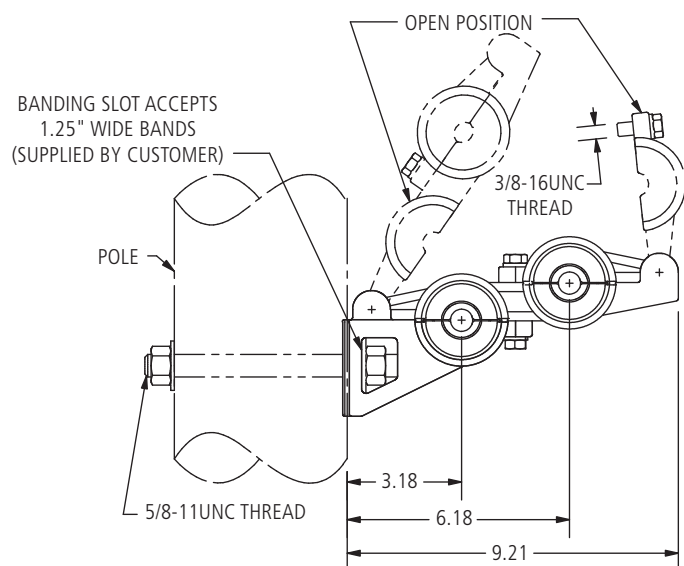

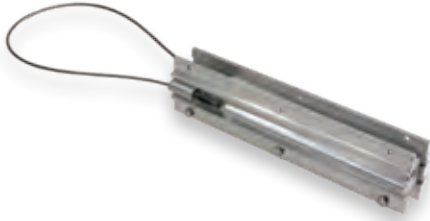

ADEW10J1-AL535



ADEW16J1-AL693

Wedge Dead End

(to be used only on Standard ADSS Cable up to 0.890" diameter, 144 fibers)

AFL offers wedge dead ends that ease and speed ADSS cable installation. The ADSS Wedge Dead End is ideal in crowded distribution environments because its shorter length allows for safer and efficient installation. The Wedge Dead End comes with all parts assembled. The side plates are properly aligned with spacers and self-locking hex bolts, as well as retainers. Lubricated wedges are pre-installed inside the body of the dead end.

Caution: The load ratings shown here are based on performance results of certain cable configurations and may not be representative of all manufacturers' ADSS cable designs. AFL strongly recommends that before using this product, you contact AFL to obtain the recommended load rating and to verify that the wedge dead end has been qualified for use with the proposed cable. AFL will perform a qualification test at no charge.

Specifications

PARAMETER	VALUE
Wedge Length	10" or 16" depending on cable characteristics
Cable O.D.	0.512" to 0.890" (13 mm to 22.6 mm)
Hold Strength	100% of Maximum Rated Cable Load (MRCL)
Maximum Attenuation Change	0.05 dB at 100% MRCL

Benefits

- Wedge-type design is safer than spiral wrap style dead ends
- Fewer parts, smaller and easier to store
- Attaches to structure via common pole hardware sold separately (thimble eye, ram's head, etc.)

Features

- Easier and faster installation
- Lower total system costs
- No special tools or hardware required for installation

APPLICATION & DESCRIPTION	AFL NO.
ADSS Mini-Span® 535 500 ft NESC heavy, 700 ft NESC medium, 875 ft NESC light Maximum loading capability is 1500 lbs.	ADEW10J1-AL535
ADSS Mini-Span 693 500 ft NESC heavy, 600 ft NESC medium, 750 ft NESC light Maximum loading capability is 1500 lbs.	ADEW16J1-AL693

Ordering Information for Double Jacket Cables

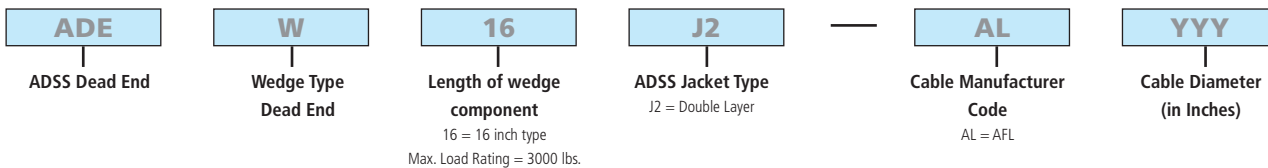

Application Notes:

1. For use with ADSS cables with polyethylene jackets in low voltage environments only. Not for use in high voltage environments where tracking resistant cables are required.
2. AFL fiber optic cable and related hardware are designed to work as a system. Dead ends may not be available for cable from other manufacturers.

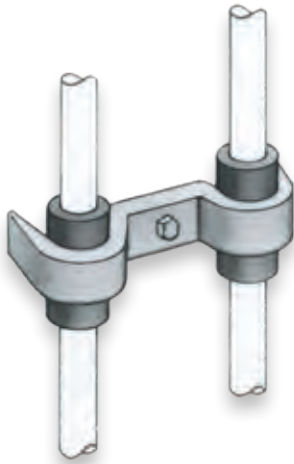

Wood Pole Clamp

Wood Pole Clamps for OPGW

Guide clamps are typically two groove clamps used to guide the cable to splice locations. Clamps are spaced 5 to 8 feet apart to help maintain alignment of the cable down the towers or poles. Not applicable to OGW series.

Features

- Slip strength: >100 lbs.

Ordering Information – Wood Pole Clamp

(Note: not available with metric hardware; 3/8" x 3" lag bolt included)

OPGW DIAMETER IN. (MM)	DIMENSIONS IN. (MM)		WEIGHT LBS. (KG)	AFL NO.
	A	B		
0.469 - 0.561 (11.9 - 14.2)	2.81 (71)	4.25 (108)	0.33 (0.15)	OGW469/561
0.562 - 0.655 (14.3 - 16.6)	3.50 (89)	5.19 (132)	0.46 (0.21)	OGW562/655
0.656 - 0.750 (16.7 - 19.1)	3.50 (89)	5.19 (132)	0.46 (0.21)	OGW656/750

Ordering Example: For AC-64/528 AlumaCore OPGW, the part number is OGW469/561.

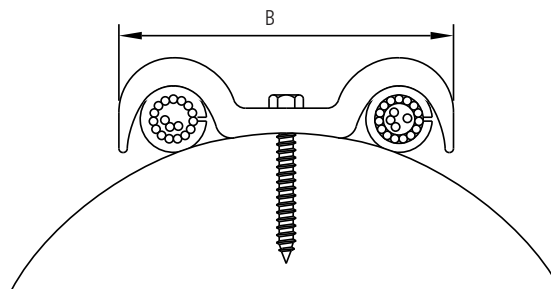
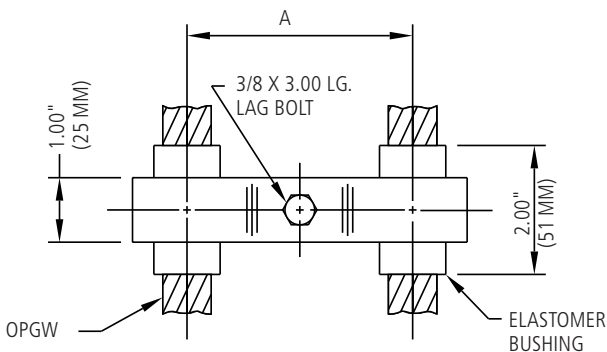

AVD Series Spiral Vibration Dampers

AFL's AVD Series Spiral Vibration Dampers are designed to eliminate the damage caused by Aeolian vibration and reduce overall vibration on bare All-Dielectric Self-Supporting (ADSS) cables. Made of weather-resistant, non-corrosive plastic, these dampers have a large, helically-formed damping section sized for the ADSS cable. A smaller gripping section gently grips the ADSS cable. Each damper is marked with the conductor range and color coded to indicate the cable diameter size range.

Line design, temperature, tension, wind flow exposure and history of vibration on similar construction in the location are factors to consider when determining the amount of protection required. Installation can be on both sides of the support location—at least one hand-width from the ends of Armor Rods or cable hardware. Depending on the customer's specific conditions, AFL recommends the AVD Spiral Vibration Damper for ADSS cable in accordance with the recommended application chart.

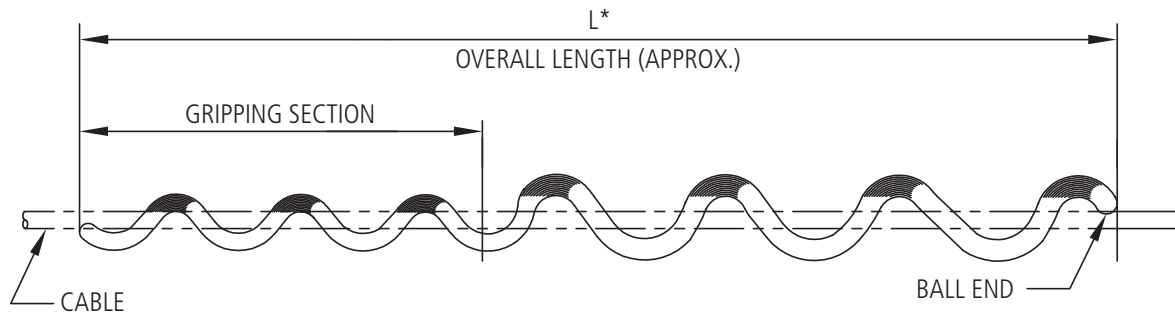
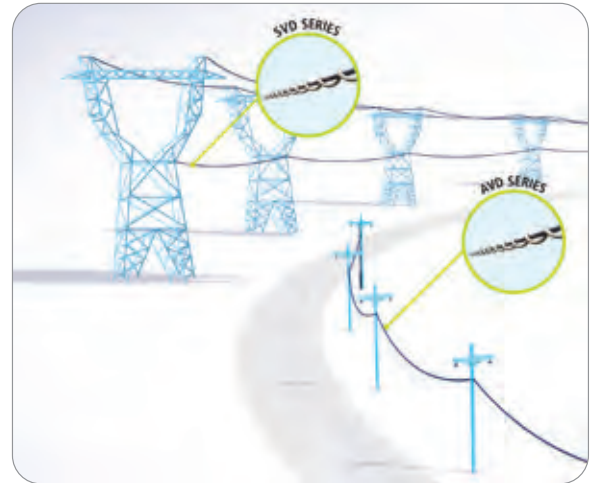

* For "L" dimensions, see table below.

Ordering Information

Select catalog number based on cable diameter. Example: for 0.512" diameter, order AVD462/563

Conductor Diameter Cross Reference

AFL NO.	PLP NO.	CONDUCTOR DIAMETER RANGE inches (mm)	"L" ROD LENGTH inches (mm)	WEIGHT lbs (KG)	STANDARD PACK
AVD250/326	50502393	0.250-0.326 (6.35-8.29)	49 (1244)	27 (12.247)	50
AVD327/461	50502272	0.327-0.461 (8.30-11.72)	51 (1295)	30 (12.701)	50
AVD462/563	50502274	0.462-0.563 (1.73-14.32)	53 (1346)	30 (13.608)	50
AVD564/770	50509862	0.564-0.770 (14.33-19.30)	64 (1625)	47 (21.319)	25
AVD771/876	50503057	0.771-0.876 (19.58-22.25)	71 (1803)	29 (13.154)	25
AVD877/1000	50503576	0.877-1.000 (22.26-25.40)	75 (1905)	36 (16.329)	25
AVD1001/1250	50503909	1.001-1.250 (25.41-31.75)	90 (2286)	41 (18.597)	25

continued
→

AVD Series Spiral Vibration Dampers (cont.)

Damper Recommendations for Placement

Damper Recommendation applies for specified AFL dampers only. If alternative type or different manufacturer dampers are applied instead, it is possible that damage will occur on the conductor and/or the accessories.

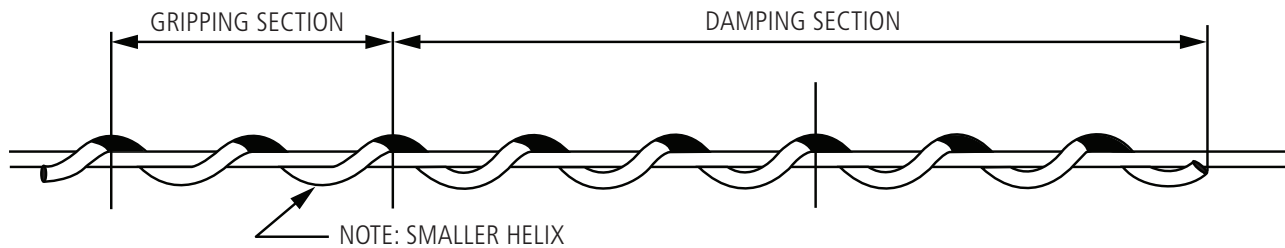

SPAN LENGTH	INITIAL TENSION PERCENTAGE OF CABLE RATED BREAKING STRENGTH (RBS) AT NOMINAL TEMPERATURE 60°F				
	0-10%	11-15%	16-20%	21-25%	>25%
< 250 ft.	0	2/s	2/s	2/s	2/s
251-500	2/s	2/s	2/s	2/s	4/s
501-800	2/s	2/s	2/s	4/s	4/s
801-1600	4/s	4/s	4/s	6/s	6/s
1601-2400	6/s	6/s	6/s	8/s	8/s
2401-3000	8/s	8/s	8/s	10/s	10/s
3001-3500	10/s	10/s	10/s	12/s	12/s
3501-4000	12/s	12/s	12/s	16/s	16/s
4001-4500	16/s	16/s	16/s	16/s	18/s
4501-5000	18/s	18/s	18/s	18/s	20/s

Symbol Designation

- 2/s = 2 dampers per span, 1 on each end of the span
- 4/s = 2 dampers in tandem on each end of the span
- 6/s = 3 dampers in tandem on each end of the span
- 8/s = 3 dampers in tandem + 1 damper on each end of the span
- 10/s = 3 dampers in tandem + 2 dampers in tandem on each end of the span
- 12/s = 3 dampers in tandem + 3 dampers in tandem on each end of the span
- 16/s = 3 dampers in tandem + 3 dampers in tandem + 2 dampers in tandem on each end of the span
- 18/s = 3 dampers in tandem + 3 dampers in tandem + 3 dampers in tandem on each end of the span
- 20/s = 4 dampers in tandem + 3 dampers in tandem + 3 dampers in tandem on each end of the span

Placement and Spacing

1. AVD shall be placed approximately 5 inches away from any line hardware (suspension, deadend, armor rods, other SVDs, etc.).
2. AVDs can be nested in tandem for up to three units to prevent the units from interfering with each other.
3. AVDs shall be applied to bare cable only to ensure proper performance.

SVD Series Spiral Vibration Dampers

AFL's SVD Series Spiral Vibration Dampers are designed to eliminate the damage caused by Aeolian vibration and reduce overall vibration on bare cables. Made of weather-resistant, non-corrosive plastic, these dampers have a large, helically-formed damping section sized for the cable. A smaller gripping section gently grips the cable. Each damper is marked with the conductor range and color coded to indicate the cable diameter size range.

Line design, temperature, tension, wind flow exposure and history of vibration on similar construction in the location are factors to consider when determining the amount of protection required. Installation can be on both sides of the support location—at least one hand-width from the ends of Armor Rods or cable hardware. Depending on the customer's specific conditions, AFL recommends the SVD Spiral Vibration Damper in accordance with the recommended application chart for the following:

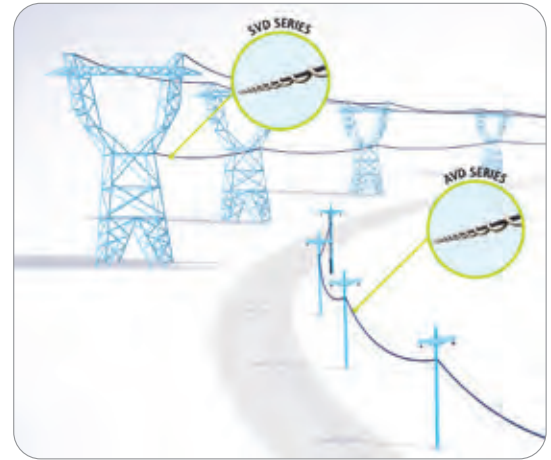

- Conductors between 0.250 inches and 0.500 inches O.D. (used with tietop insulators and rural construction)
- Optical Ground Wires (OPGW) and Overhead Ground Wires (OHGW) in accordance with the recommended application chart

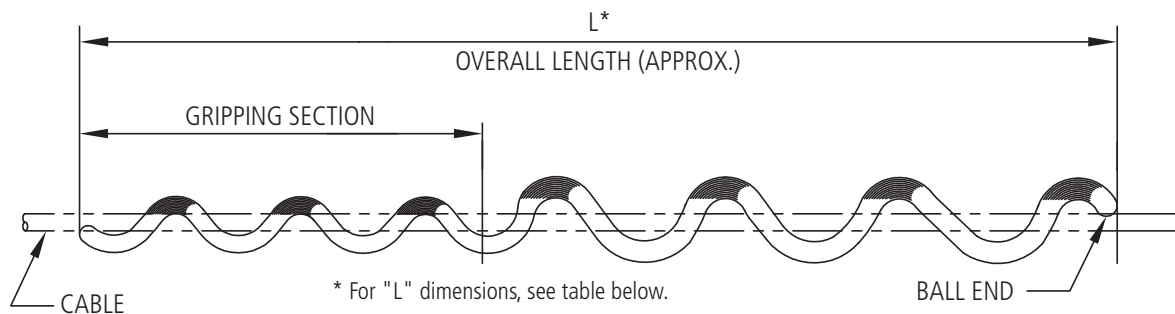

Ordering Information

Select catalog number based on cable diameter. Example: for 0.512" diameter, order SVD462/563

Conductor Diameter Cross Reference

AFL NO.	PLP NO.	CONDUCTOR DIAMETER RANGE INCHES (MM)	"L" ROD LENGTH INCHES (MM)	WEIGHT LBS (KG)	COLOR CODE	STANDARD PACK
SVD250/326	5050103	0.250-0.326 (6.35-8.29)	49 (1244)	29 (13.154)	Light Blue	50
SVD327/461	5050104	0.327-0.461 (8.30-11.72)	51 (1295)	31 (14.061)	Black	50
SVD462/563	5050105	0.462-0.563 (1.73-14.32)	53 (1346)	34 (15.422)	Yellow	50
SVD564/770	5050106	0.564-0.770 (14.33-19.30)	64 (1625)	50 (22.679)	Green	25

High Mass Cross Reference

AFL NO.	PLP NO.	CONDUCTOR DIAMETER RANGE INCHES (MM)	"L" ROD LENGTH INCHES (MM)	WEIGHT LBS (KG)	COLOR CODE	STANDARD PACK
SVD250/326HM	5050200	0.250-0.326 (6.35-8.29)	87 (2209)	55 (24.948)	Light Blue	50
SVD327/461HM	5050201	0.327-0.461 (8.30-11.72)	91 (2311)	60 (27.216)	Black	50
SVD462/563HM	5050202	0.462-0.563 (1.73-14.32)	94 (2387)	65 (29.483)	Yellow	50
SVD564/770HM	5050203	0.564-0.770 (14.33-19.30)	96 (2438)	55 (24.948)	Green	25

continued
→

SVD Series Spiral Vibration Dampers (cont.)

Damper Recommendations for Placement

Damper Recommendation applies for specified AFL dampers only. If alternative type or different manufacturer dampers are applied instead, it is possible that damage will occur on the conductor and/or the accessories.

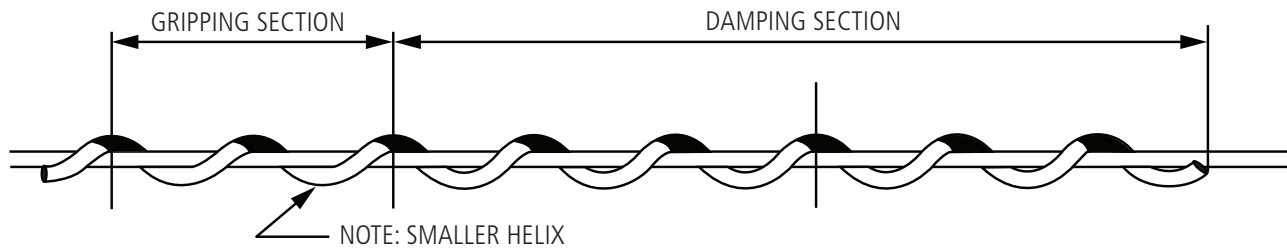

SPAN LENGTH	INITIAL TENSION PERCENTAGE OF CABLE RATED BREAKING STRENGTH AT NOMINAL TEMPERATURE 60°F							
	0-10%		11-15%		16-20%		>20%	
	STANDARD	HIGH MASS	STANDARD	HIGH MASS	STANDARD	HIGH MASS	STANDARD	HIGH MASS
< 800 ft.	2/s	1/s	2/s	1/s	4/s	2/s	4/s	2/s
801-1400 ft.	4/s	2/s	4/s	2/s	6/s	4/s	6/s	4/s
1401-2400 ft.	6/s	4/s	6/s	4/s	8/s	4/s	8/s	4/s
2401-3000 ft.	8/s	4/s	8/s	4/s	10/s	6/s	10/s	6/s
3001-3500 ft.	10/s	6/s	10/s	6/s	12/s	6/s	12/s	6/s
3501-4000 ft.	12/s	6/s	12/s	6/s	16/s	8/s	16/s	8/s
4001-4500 ft.	16/s	8/s	16/s	8/s	18/s	10/s	18/s	10/s
4501-5000 ft.	18/s	10/s	18/s	10/s	20/s	10/s	20/s	10/s

Symbol Designation

- 2/s = 2 dampers per span, 1 on each end of the span
- 4/s = 2 dampers in tandem on each end of the span
- 6/s = 3 dampers in tandem on each end of the span
- 8/s = 3 dampers in tandem + 1 damper on each end of the span
- 10/s = 3 dampers in tandem + 2 dampers in tandem on each end of the span
- 12/s = 3 dampers in tandem + 3 dampers in tandem on each end of the span
- 16/s = 3 dampers in tandem + 3 dampers in tandem + 2 dampers in tandem on each end of the span
- 18/s = 3 dampers in tandem + 3 dampers in tandem + 3 dampers in tandem on each end of the span
- 20/s = 3 dampers in tandem + 3 dampers in tandem + 3 dampers in tandem + 1 damper on each end of the span

Placement and Spacing

1. SVD shall be placed approximately 5 inches away from any line hardware (suspension, deadend, armor rods, other SVDs, etc.).
2. SVDs can be nestled in tandem for up to three units to prevent the units from interfering with each other.
3. SVDs shall be applied to bare cable only to ensure proper performance.

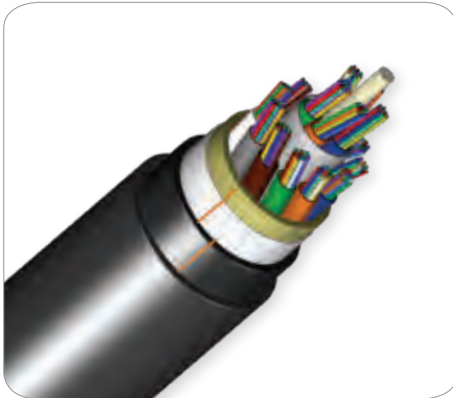

All-Dielectric Armored Rodent-Resistant OSP Loose Tube (LN Series)

AFL's All-dielectric Rodent-Resistant cable is designed for environments that have an increased risk of rodent infestation and disturbance. The LN-series product line covers the range of fiber counts of up to 432 fibers. The ultra-hard, non-metallic outer polymer shell reduces the risk of transmission interruptions in vital OSP network interconnections.

Features

- Fiber counts up to 432
- All-dielectric Armor
- Double jacket design provides additional protection to the fibers
- Gel-filled tubes are reverse-oscillated (SZ stranded) to allow slack for mid-span access

Applications

- Direct Buried
- Long Haul Networking
- Building Interconnections (Campus LAN)
- Steam-tunnel Substreet Drainage Networks
- Airport (FAA-E-2761c, Type B)

Typical Lengths

FIBER COUNT	MAXIMUM LENGTHS*			
	SINGLE-MODE		MULTIMODE	
	FEET	METERS	FEET	METERS
6 - 60	22,900	7,000	22,900	8,000
72 - 96	22,900	7,000	22,900	7,000
108 - 120	22,900	7,000	22,900	7,000
132 - 144	22,600	6,900	22,600	6,900
146 - 216	17,000	5,200	17,000	5,200
218 - 288	15,000	4,600	15,000	4,600
290 - 432	10,800	3,300	10,800	3,300

* Longer lengths may be available upon request.

Cable Components

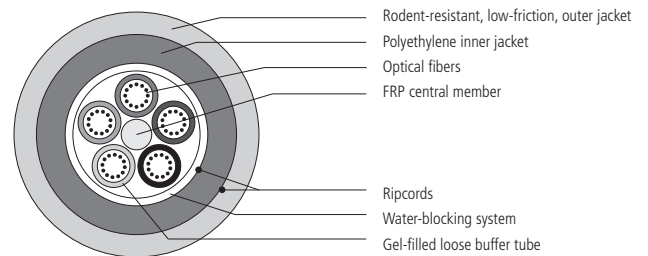

Fiber Specifications

FIBER TYPE	MAXIMUM ATTENUATION (DB/KM)				OVERFILL LAUNCH MIN. BANDWIDTH (MHZ•KM)		GIGABIT ETHERNET MIN. LINK DISTANCE (METERS)	
	850 NM	1300 NM	1310 NM	1550 NM	850 NM	1300 NM	850 NM	1300 NM
	(6) 62.5/125 GIGA-Link™ 300	3.5	1.2	N/A	N/A	200	600	300
(5) 50/125 GIGA-Link™ 600	2.9	0.9	N/A	N/A	500	500	600	600
(L) 50/125 Laser-Link™ 300	2.9	0.9	N/A	N/A	1500	500	900	550
(9) Single-mode	N/A	N/A	0.35	0.25	N/A	N/A	N/A	5000
(Q) Non-zero Dispersion-shifted Single-mode	N/A	N/A	N/A	0.25	N/A	N/A	N/A	N/A

Gigabit Ethernet Minimum Link Distances are based on "bandwidth"/modal dispersion constraints. Actual link distances may be constrained by attenuation, depending on specific loss budget.

continued
→

All-Dielectric Armored Rodent-Resistant OSP Loose Tube (LN Series)

Ordering Information

AFL NO.	FIBER COUNT	NUMBER OF TUBES/FIBERS	NOMINAL DIAMETER		NOMINAL WEIGHT		MAXIMUM TENSILE LOAD		MINIMUM BEND RADIUS	
			INCHES	MM	LBS/1,000FT	KG/KM	LBS (N)		INCHES (CM)	
							SHORT TERM	LONG TERM	SHORT TERM	LONG TERM
LN006★C5101N1	6	1w/6 (4 fillers)	0.49	12.5	56	84	600 (2670)	200 (890)	9.8 (25)	7.4 (19)
LN012★C5101N1	12	1w/12 (4 fillers)	0.49	12.5	56	84	600 (2670)	200 (890)	9.8 (25)	7.4 (19)
LN018★C5101N1	18	1w/12,1w/6 (3 fillers)	0.49	12.5	56	84	600 (2670)	200 (890)	9.8 (25)	7.4 (19)
LN024★C5101N1	24	2w/12 (3 fillers)	0.49	12.5	56	84	600 (2670)	200 (890)	9.8 (25)	7.4 (19)
LN030★C5101N1	30	2w/12,1w/6 (2 fillers)	0.49	12.5	56	84	600 (2670)	200 (890)	9.8 (25)	7.4 (19)
LN036★C5101N1	36	3w/12 (2 fillers)	0.49	12.5	56	84	600 (2670)	200 (890)	9.8 (25)	7.4 (19)
LN048★C5101N1	48	4w/12 (1 filler)	0.49	12.5	56	84	600 (2670)	200 (890)	9.8 (25)	7.4 (19)
LN060★C5101N1	60	5w/12 (no fillers)	0.49	12.5	56	84	600 (2670)	200 (890)	9.8 (25)	7.4 (19)
LN072★C6101N1	72	6w/12 (no fillers)	0.53	13.4	65	97	600 (2670)	200 (890)	10.6 (27)	8.0 (21)
LN084★C8101N1	84	7w/12 (1 filler)	0.60	15.2	81	121	600 (2670)	200 (890)	12.0 (31)	9.0 (23)
LN096★C8101N1	96	8w/12 (no fillers)	0.60	15.2	81	121	600 (2670)	200 (890)	12.0 (31)	9.0 (23)
LN108★CA101N1	108	9w/12 (1 filler)	0.67	17.1	101	151	600 (2670)	200 (890)	13.4 (35)	10.1 (26)
LN120★CA101N1	120	10w/12 (no fillers)	0.67	17.1	101	151	600 (2670)	200 (890)	13.4 (35)	10.1 (26)
LN132★CC101N1	132	11w/12 (1 filler)	0.75	19.0	123	184	600 (2670)	200 (890)	15.0 (39)	11.3 (29)
LN144★CC101N1	144	12w/12 (no fillers)	0.75	19.0	123	184	600 (2670)	200 (890)	15.0 (39)	11.3 (29)
LN216★CI301N1	216	18w/12 (no fillers)	0.76	19.3	125	187	600 (2670)	200 (890)	15.2 (39)	11.4 (29)
LN288★OC101N1	288	12w/24 (no fillers)	0.73	18.6	183	272	600 (2670)	200 (890)	14.6 (38)	11.0 (28)
LN432★OI301N1	432	18w/24 (no fillers)	0.72	18.4	181	269	600 (2670)	200 (890)	14.4 (37)	10.8 (28)

Note: Diameter and weight subject to change without notice

★ Fiber Types – Replace asterisk (★) in AFL number with number in the Fiber Specifications table on previous page.

Reel Information

ITEM	REEL A		REEL B		REEL C		REEL D		REEL E	
	INCHES	CM	INCHES	CM	INCHES	CM	INCHES	CM	INCHES	CM
Reel Height	42	106.7	58	147.3	66	167.6	72	182.8	84	213.4
Reel Width Outside	36	91.4	38	96.5	42	106.7	42	106.7	40	101.6
Reel Width Inside	32	81.6	32	81.3	36	91.4	36	91.4	34	86.4
Drum Diameter	23	58.7	28	71.1	36	91.4	36	91.4	35	88.9
Arbor Hole Diameter	3	7.9	3	7.9	3	7.9	3	7.9	3	7.9
Reel Weight With Lagging	180 lbs	82 kg	420 lbs	191 kg	685 lbs	311 kg	710 lbs	320 kg	950 lbs	431 kg

AFL typically provides Loose Tube cable on several standard sizes of non-returnable wooden reels. Non-standard reel sizes are available upon request. Larger reel sizes may be required to accommodate long cable lengths.

Qualifications

GOVERNING BODY	STANDARD CODE	COMPONENT
Telcordia	GR-20-CORE	Cable
ICEA	640	Cable
TIA	598-D	Fiber

Temperature Specifications

TEMPERATURE RANGE	
Operation	-40°C to +70°C
Storage	-40°C to +75°C
Installation	-30°C to +70°C

Contact AFL for your customized cable solution.

Fiber Optic Cable

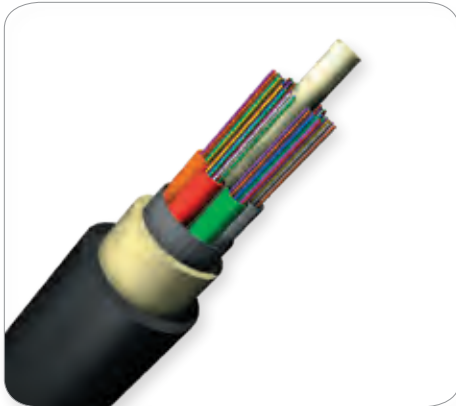

Riser Single-Jacket Non-Armored I/O Loose Tube (LV Series SJ)

Indoor/outdoor stranded loose tube combines the robust mechanical and environmental characteristics of an outside plant cable with the flexibility of an inside plant riser cable. By installing an indoor/outdoor stranded loose tube, splice locations entering into a building are avoided, being routed directly from the outside plant to telecommunications closets, or main distribution frames (MDF) through the riser of a building and eliminating the "50-foot rule." Indoor/Outdoor Stranded Design loose tube cable is moisture and U.V. resistant and is SZ stranded to allow slack for mid-span access, listed for OFNR use per UL standards, and can be used in both duct and lashed applications.

Features

- Fiber counts up to 144
- Compact design
- Gel-filled or gel-free tubes are reverse-oscillated (SZ stranded) to allow slack for mid-span access

Applications

- Underground Duct
- Long Haul Networking
- Building Interconnections (Campus LAN)
- Trunking Lines Direct to Telecommunications Closet
- Local Loop
- Intra-building Backbones
- Distance Learning

Typical Lengths

FIBER COUNT	MAXIMUM LENGTHS*			
	SINGLE-MODE		MULTIMODE	
	FEET	METERS	FEET	METERS
6 - 144	22,900	7,000	22,900	7,000

* Longer lengths may be available.

Cable Components

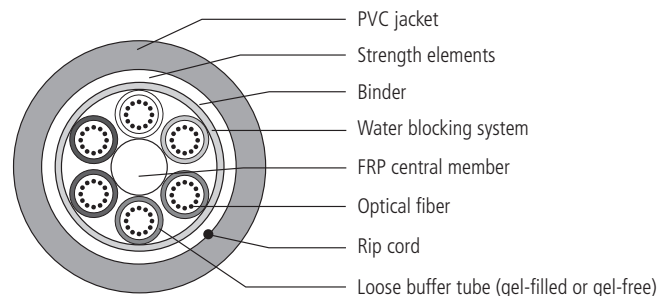

Fiber Specifications

FIBER TYPE	MAXIMUM ATTENUATION (DB/KM)				OVERFILL LAUNCH MIN. BANDWIDTH (MHZ•KM)		GIGABIT ETHERNET MIN. LINK DISTANCE (METERS)	
	850 NM	1300 NM	1310 NM	1550 NM	850 NM	1300 NM	850 NM	1300 NM
(6) 62.5/125 GIGA-Link™ 300	3.5	1.2	N/A	N/A	200	600	300	550
(5) 50/125 GIGA-Link™ 600	2.9	0.9	N/A	N/A	500	500	600	600
(L) 50/125 Laser-Link™ 300	2.9	0.9	N/A	N/A	1500	500	900	550
(9) Single-mode	N/A	N/A	0.35	0.25	N/A	N/A	N/A	5000
(Q) Non-zero Dispersion-shifted Single-mode	N/A	N/A	N/A	0.25	N/A	N/A	N/A	N/A

Gigabit Ethernet Minimum Link Distances are based on "bandwidth"/modal dispersion constraints. Actual link distances may be constrained by attenuation, depending on specific loss budget.

continued
→

Riser Single-Jacket Non-Armored I/O Loose Tube (LV Series SJ)

Ordering Information

AFL NO.	FIBER COUNT	NUMBER OF TUBES/FIBERS	NOMINAL DIAMETER		NOMINAL WEIGHT		MAXIMUM TENSILE LOAD		MINIMUM BEND RADIUS	
			INCHES (MM)	LBS/1,000 FT (KG/KM)	LBS. (N)		INCHES (CM)			
					SHORT TERM	LONG TERM	SHORT TERM	LONG TERM		
GEL-FILLED										
LV006★C5101N1	6	1w/6 (4 fillers)	0.51 (12.9)	107 (159)	600 (2700)	200 (890)	10.2 (26)	7.7 (20)		
LV012★C5101N1	12	1w/12 (4 fillers)	0.51 (12.9)	108 (160)	600 (2700)	200 (890)	10.2 (26)	7.7 (20)		
LV018★C5101N1	18	1w/12, 1w/6 (3 fillers)	0.51 (12.9)	108 (161)	600 (2700)	200 (890)	10.2 (26)	7.7 (20)		
LV024★C5101N1	24	2w/12 (3 fillers)	0.51 (12.9)	108 (161)	600 (2700)	200 (890)	10.2 (26)	7.7 (20)		
LV030★C5101N1	30	2w/12, 1w/6 (2 fillers)	0.51 (12.9)	109 (162)	600 (2700)	200 (890)	10.2 (26)	7.7 (20)		
LV036★C5101N1	36	3w/12 (2 fillers)	0.51 (12.9)	109 (162)	600 (2700)	200 (890)	10.2 (26)	7.7 (20)		
LV048★C5101N1	48	4w/12 (1 filler)	0.51 (12.9)	110 (164)	600 (2700)	200 (890)	10.2 (26)	7.7 (20)		
LV060★C5101N1	60	5w/12 (No fillers)	0.51 (12.9)	111 (165)	600 (2700)	200 (890)	10.2 (26)	7.7 (20)		
LV072★C6101N1	72	6w/12 (No fillers)	0.54 (13.7)	128 (190)	600 (2700)	200 (890)	10.8 (28)	8.1 (21)		
LV084★C8101N1	84	7w/12 (1 filler)	0.61 (15.5)	158 (236)	600 (2700)	200 (890)	12.2 (31)	9.2 (24)		
LV096★C8101N1	96	8w/12 (No fillers)	0.61 (15.5)	159 (237)	600 (2700)	200 (890)	12.2 (31)	9.2 (24)		
LV108★CA101N1	108	9w/12 (1 filler)	0.69 (17.4)	197 (294)	600 (2700)	200 (890)	14.0 (35)	10.4 (27)		
LV120★CA101N1	120	10w/12 (No fillers)	0.69 (17.4)	198 (295)	600 (2700)	200 (890)	14.0 (35)	10.4 (27)		
LV132★CC101N1	132	11w/12 (1 filler)	0.76 (19.3)	242 (360)	600 (2700)	200 (890)	15.2 (39)	11.4 (29)		
LV144★CC101N1	144	12w/12 (No fillers)	0.76 (19.3)	243 (361)	600 (2700)	200 (890)	15.2 (39)	11.4 (29)		
GEL-FREE										
LV012★C5101N1D	12	1/12 (4 fillers)	0.48 (12.3)	100 (148)	600 (2670)	180 (800)	9.7 (25)	7.2 (19)		
LV024★C5101N1D	24	2/12 (3 fillers)	0.48 (12.3)	99 (146)	600 (2670)	180 (800)	9.7 (25)	7.2 (19)		
LV036★C5101N1D	36	3/12 (2 fillers)	0.48 (12.3)	99 (147)	600 (2670)	180 (800)	9.7 (25)	7.2 (19)		
LV048★C5101N1D	48	4/12 (1 filler)	0.48 (12.3)	99 (147)	600 (2670)	180 (800)	9.7 (25)	7.2 (19)		
LV060★C5101N1D	60	5/12 (no fillers)	0.48 (12.3)	98 (146)	600 (2670)	180 (800)	9.7 (25)	7.2 (19)		
LV072★C6101N1D	72	6/12 (no fillers)	0.52 (13.1)	103 (154)	600 (2670)	180 (800)	10.3 (26)	7.8 (20)		
LV096★C8101N1D	96	8/12 (no fillers)	0.58 (14.7)	138 (205)	600 (2670)	180 (800)	11.6 (29)	8.7 (23)		
LV144★CC101N1D	144	12/12 (no fillers)	0.72 (18.2)	198 (295)	600 (2670)	180 (800)	14.3 (37)	10.8 (28)		

Note: Diameter and weight subject to change without notice

★ Fiber Types – Replace asterisk (★) in AFL number with number in the Fiber Specifications table on previous page.

Reel Information

ITEM	REEL A		REEL B		REEL C		REEL D		REEL E	
	INCHES	CM	INCHES	CM	INCHES	CM	INCHES	CM	INCHES	CM
Reel Height	42	106.7	58	147.3	66	167.6	72	182.8	84	213.4
Reel Width Outside	36	91.4	38	96.5	42	106.7	42	106.7	40	101.6
Reel Width Inside	32	81.6	32	81.3	36	91.4	36	91.4	34	86.4
Drum Diameter	23	58.7	28	71.1	36	91.4	36	91.4	35	88.9
Arbor Hole Diameter	3	7.9	3	7.9	3	7.9	3	7.9	3	7.9
Reel Weight With Lagging	180 lbs	82 kg	420 lbs	191 kg	685 lbs	311 kg	710 lbs	320 kg	950 lbs	431 kg

AFL typically provides Loose Tube cable on several standard sizes of non-returnable wooden reels. Non-standard reel sizes are available upon request.

Larger reel sizes may be required to accommodate long cable lengths.

Qualifications

GOVERNING BODY	STANDARD CODE	COMPONENT
Telcordia	GR-20-CORE	Cable
UL	1666 (OFNR)	Cable
ICEA	S-104-696	Cable
CSA	22.2 (FT4)	Cable
TIA	598-D	Fiber

Temperature Specifications

TEMPERATURE RANGE	
Operation	-40°C to +70°C
Storage	-40°C to +70°C
Installation	-30°C to +70°C

Contact AFL for your customized cable solution.

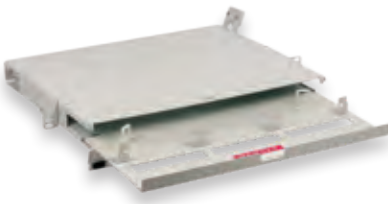

LightLink LANSystem 1RU Fiber Termination Patch/Splice Panel

The AFL 1RU Fiber Termination Patch/Splice Panel is designed for use as a rack mount interconnect point where termination and connectivity of up to 36 fibers is desired. The panel design is based on a 1 rack unit height and is provisioned with three LGX® 118 compatible mounting positions that can accommodate adapter plates, XFM® optical cassettes, passive optical modules or any combination therein.

Standard 1RU Fiber Termination Patch Panels are available empty for complete field configuration, half loaded with adapter plates, or stubbed with a factory installed circular premise cable (CPC) or loose tube cable assembly.

Standard 1RU Fiber Patch and Splice Panels are available empty for complete field configuration, half loaded with adapter plates and splice trays, or loaded with pigtails, adapter plates and splice trays.

Features

- Fits comfortably into new and existing interconnect, cross-connect, customer premise, and co-location environments
- Most common connector styles and types available
- Compatible with industry standard equipment frames
- Modular design
- Slide-out tray with relief cut-outs for simplified connector access
- Optional splice tray kit for on site conversion to patch and splice panel
- Optional front door key lock for heightened protection of internal components

Applications

- Telecommunications closets
- Data Centers
- Customer Premise
- LAN / WAN Networks
- Central Offices / Headends
- Hubs / Cabinets / Remote Terminals
- FTTH / FTTB Networks

Specifications

- Designed around Telcordia® GR-63NEBS
- Aluminum construction per ASTMB209
- Durable textured powder coat finish available in black or white
- Universal 19/23" EIA/TIA rack compatibility
- Standard density: up to 18-fiber
- High density: up to 36-fiber
- LGX 118 compatible
- Standard cable stub location is right rear exiting upward
- 1RU Patch and Splice Panel holds up to three splice tray kits

Dimensions

DEPTH (A) IN INCHES	WIDTH (B) IN INCHES	HEIGHT (C) IN INCHES	RACK UNITS	CAPACITY	UNLOADED WEIGHT
13.51	17.00	1.75	1	18 / 36	4 lbs.

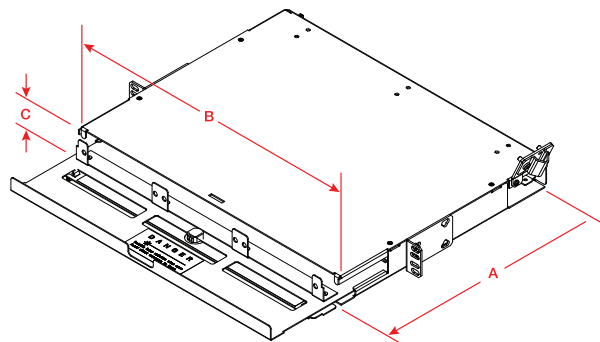

LGX is a registered trademark of Furukawa Electric North America, Inc.
Telcordia is a registered trademark of Telcordia Technologies, Inc.

LightLink LANSysystem 1RU Fiber Termination Patch/Splice Panel

Ordering Information

Select the seven digit AFL panel part number, specify the color, and choose the loading character desired.

When ordering stubbed (S), enter the cable stub length required in meters.

Note: Standard stub is Circular Premise Cable (CPC).

AFL NO.	Color	Loading Character	Cable Stub Length (M)
FM001344	B	S	0010
	W = White B = Black	E = Empty H = Half-loaded with adapters L = Loaded with adapters and pigtails (Patch and Splice only) S = Preterminated with tight buffered CPC cable stub (Riser) (Patch only) R = Preterminated with OSP loose tube cable stub (Patch only)	0002 = 2 meters 0004 = 4 meters etc.

Example: Order number for a panel Black in color, loaded with 12 PSC adapters (2 six packs), connectors and a cable stub 10 meters in length.

Ordering Information

CONFIGURATION	AFL NO.
CON012P—1 RU PATCH PANELS—12 FIBERS—LGX118	
EMPTY	FM001038
12 PSC adapters (2 Six Packs)	FM001344
12 UST adapters (2 Six Packs)	FM001346
12 PST adapters (2 Six Packs)	FM001347
6 UDL (dup) adapters (2 Three Packs)	FM001353
6 PDL (dup) adapters (2 Three Packs)	FM001354
12 ASC adapters (2 Six Packs)	FM001352
12 UFC adapters (2 Six Packs)	FM001349
12 USC adapters (2 Six Packs)	FM001351
12 AFC adapters (2 Six Packs)	FM001350
CON024HD—1 RU HIGH DENSITY PATCH PANELS—24 FIBERS—LGX118	
24 UST adapters (2 Twelve Packs)	FM001355
24 PST adapters (2 Twelve Packs)	FM001356
12 PDL (dup) adapters (2 Six Packs)	FM001348
12 USF (dup) adapters (2 Six Packs)	FM001357
12 ASF (dup) adapters (2 Six Packs)	FM001358

CONFIGURATION	AFL NO.
CNS012P—1RU PATCH AND SPLICE PANELS—12 FIBERS—LGX118	
EMPTY	FM001328
12 PSC adapters (2 Six Packs), Splice Tray	FM001323
12 UST adapters (2 Six Packs), Splice Tray	FM001329
12 PST adapters (2 Six Packs), Splice Tray	FM001325
6 UDL (dup) adapters (2 Three Packs), Splice Tray	FM001334
6 PDL (dup) adapters (2 Three Packs), Splice Tray	FM001335
12 ASC adapters (2 Six Packs), Splice Tray	FM001333
12 UFC adapters (2 Six Packs), Splice Tray	FM001330
12 USC adapters (2 Six Packs), Splice Tray	FM001332
12 AFC adapters (2 Six Packs), Splice Tray	FM001331
CNS024HD—1 RU HIGH-DENSITY PATCH & SPLICE PANELS—24 FIBERS—LGX118	
24 UST adapters (2 Twelve Packs), Splice Tray	FM001336
24 PST adapters (2 Twelve Packs), Splice Tray	FM001337
12 USF (dup) adapters (2 Six Packs), Splice Tray	FM001338
12 ASF (dup) adapters (2 Six Packs), Splice Tray	FM001339

Qualifications

GOVERNING BODY	STANDARD CODE
ASTM	ASTMB209
Telcordia	GR-63NEBS

Accessories

DESCRIPTION	AFL NO.
Splice Tray Kit: Single Fusion, 12 fiber, 1RU Patch Panel Standard Density (1 splice tray)	FM002826-1
Splice Tray Kit: Single Fusion, 12 fiber, 1RU Patch Panel High Density (2 splice trays)	FM002826-2
Ribbon Splice Tray Kit: Mass Fusion, 12 fiber, 1RU Patch Panel Standard Density (1 splice tray)	FM002826-1R
Ribbon Splice Tray Kit: Mass Fusion, 12 fiber, 1RU Patch Panel High Density (2 splice trays)	FM002826-2R
Kit, Lock, for CON/CNS Panels	FM001318

Connector/Adapter Key

TYPE	DESCRIPTION
ASC	SC—Angle Polish, Simplex, SM
ASF	SC—Angle Polish, Duplex, SM
PSC	SC—Physical Polish, Simplex, MM
PSF	SC—Physical Polish, Duplex, MM
USC	SC—Ultra Polish, Simplex, SM
USF	SC—Ultra Polish, Duplex, SM
PST	ST—Physical Polish, Simplex, MM
UST	ST—Ultra Polish, Simplex, SM
AFC	FC—Angle Polish, Simplex, SM
PFC	FC—Physical Polish, Simplex, MM
UFC	FC—Ultra Polish, Simplex, SM
ADL	LC—Angle Polish, Duplex, SM
PLC	LC—Physical Polish, Simplex, MM
PDL	LC—Physical Polish, Duplex, MM
ULC	LC—Ultra Polish, Simplex, SM
UDL	LC—Ultra Polish, Duplex, SM

Notes:

- 1) All MM cable is 62.5 μm unless otherwise specified.
- 2) When ordering Empty Termination Patch/Splice Panel, accessories are available for field configuration.



LightLink LANSystem 2RU Fiber Termination Patch/Splice Panel

The AFL 2RU Fiber Termination Patch/Splice Panel is designed for use as a rack mount interconnect point where termination and connectivity of up to 72 fibers is desired. The panel design is based on a 2 rack unit height and is provisioned with three LGX® 118 compatible mounting positions that can accommodate adapter plates, XFM optical cassettes, passive optical modules or any combination therein.

Standard 2RU Fiber Termination Patch Panels are available empty for complete field configuration, half loaded with adapter plates, or stubbed with a factory installed circular premise cable (CPC) or loose tube cable assembly.

Standard 2RU Fiber Patch and Splice Panels are available empty for complete field configuration, half loaded with adapter plates and splice trays, or loaded with pigtails, adapter plates and splice trays.

Specifications

- Designed around Telcordia® GR-63NEBS
- Aluminum construction per ASTM B209
- Durable textured powder coat finish available in black or white
- Universal 19/23" EIA/TIA rack compatibility
- Standard density: up to 36 fiber
- High density: up to 72 fiber
- LGX 118 compatible
- Standard cable stub location is right rear exiting upward
- 2RU Patch and Splice Panel holds up to four splice tray kits

Features

- Fits comfortably into new and existing interconnect, cross-connect, customer premise, and co-location environments
- Most common connector styles and types available
- Compatible with industry standard equipment frames
- Modular design
- Slide-out tray with relief cut-outs for simplified connector access
- Optional splice tray kit for on site conversion to patch and splice panel
- Optional front door key lock for height-ened protection of internal components

Applications

- Telecommunications closets
- Data Centers
- Customer Premise
- LAN / WAN Networks
- Central Offices / Headends
- Hubs / Cabinets / Remote Terminals
- FTTH / FTTB Networks

Dimensions

DEPTH (A) IN INCHES	WIDTH (B) IN INCHES	HEIGHT (C) IN INCHES	RACK UNITS	CAPACITY	UNLOADED WEIGHT
13.51	17.00	3.50	2	36 / 72*	5 lbs.

* 72 fiber capacity not available in Patch and Splice configuration.

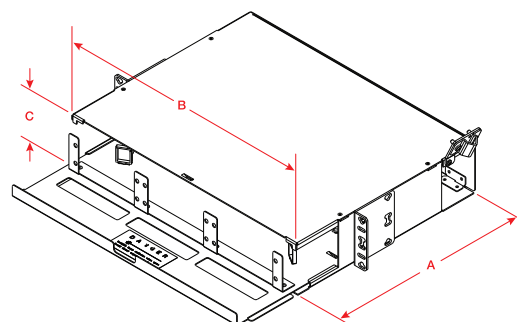

LGX is a registered trademark of Furukawa Electric North America, Inc.
Telcordia is a registered trademark of Telcordia Technologies, Inc.

LightLink LANSystem 2RU Fiber Termination Patch/Splice Panel

Ordering Information

Select the seven digit AFL panel part number, specify the color, and choose the loading character desired.

When ordering stubbed (S), enter the cable stub length required in meters.

Note: Standard stub is Circular Premise Cable (CPC).

AFL NO.	Color	Loading Character	Cable Stub Length (M)
FM001433	B	S	0010
	W = White B = Black	E = Empty H = Half-loaded with adapters L = Loaded with adapters and pigtails (Patch and Splice only) S = Preterminated with tight buffered CPC cable stub (Riser) (Patch only) R = Preterminated with OSP loose tube cable stub (Patch only)	0002 = 2 meters 0004 = 4 meters etc.

Example: Order number for a panel Black in color, loaded with 24 PSC adapters (4 six packs), connectors and a cable stub 10 meters in length.

Ordering Information

CONFIGURATION	AFL NO.
CON024P—2 RU PATCH PANELS—24 FIBERS—LGX118	
EMPTY	FM001029
24 PSC adapters (4 Six Packs) 118 LGX (Beige)	FM001433
24 UST adapters (4 Six Packs) 118 LGX	FM001434
24 PST adapters (4 Six Packs) 118 LGX	FM001435
12 UDL (dup) adapters (4 Three Packs) 118 LGX (Blue)	FM001441
12 PDL (dup) adapters (4 Three Packs) 118 LGX (Beige)	FM001442
24 ASC adapters (4 Six Packs) 118 LGX (Green)	FM001439
24 UFC adapters (4 Six Packs) 118 LGX	FM001436
24 USC adapters (4 Six Packs) 118 LGX (Blue)	FM001438
24 AFC adapters (4 Six Packs) 118 LGX	FM001437

CONFIGURATION	AFL NO.
CNS024P—2U PATCH AND SPLICE PANELS—24 FIBERS—LGX118	
EMPTY	FM001414
24 PSC adapters (4 Six Packs) 118 LGX, Splice tray	FM001411
24 UST adapters (4 Six Packs) 118 LGX, Splice tray	FM001412
24 PST adapters (4 Six Packs) 118 LGX, Splice tray	FM001413
12 UDL (dup) adapters (4 three Packs) 118 LGX , Splice tray	FM001419
12 PDL (dup) adapters (4 three Packs) 118 LGX , Splice tray	FM001420
24 ASC adapters (4 Six Packs) 118 LGX, Splice tray	FM001418
24 UFC adapters (4 Six Packs) 118 LGX, Splice tray	FM001415
24 USC adapters (4 Six Packs) 118 LGX, Splice tray	FM001417
24 AFC adapters (4 Six Packs) 118 LGX, Splice tray	FM001416

Notes:

- 1) All MM cable is 62.5 μm unless otherwise specified.
- 2) When ordering Empty Termination Patch/Splice Panel, accessories are available for field configuration.

Qualifications

GOVERNING BODY	STANDARD CODE
ASTM	ASTM B209
Telcordia	GR-63NEBS

Accessories

DESCRIPTION	AFL NO.
Splice Tray Kit: Single Fusion, 12 fiber, 2RU, WME02, WME04 (1 splice tray)	FM002827-1
Splice Tray Kit: Single Fusion, 12 fiber, 2RU, WME02, WME04 (2 splice trays)	FM002827-2
Splice Tray Kit: Single Fusion, 12 fiber, 2RU, WME02, WME04 (3 splice trays)	FM002827-3
Splice Tray Kit: Single Fusion, 12 fiber, 2RU, WME02, WME04 (4 splice trays)	FM002827-4
Splice Tray Kit: Single Fusion, 12 fiber, 2RU, WME02, WME04, Ribbon (1 splice tray)	FM002827-1R
Splice Tray Kit: Single Fusion, 12 fiber, 2RU, WME02, WME04, Ribbon (2 splice trays)	FM002827-2R
Splice Tray Kit: Single Fusion, 12 fiber, 2RU, WME02, WME04, Ribbon (3 splice trays)	FM002827-3R
Splice Tray Kit: Single Fusion, 12 fiber, 2RU, WME02, WME04, Ribbon (4 splice trays)	FM002827-4R
Kit, Lock, for CON / CNS Panels	FM001318

Connector/Adapter Key

TYPE	DESCRIPTION
ASC	SC—Angle Polish, Simplex, SM
ASF	SC—Angle Polish, Duplex, SM
PSC	SC—Physical Polish, Simplex, MM
PSF	SC—Physical Polish, Duplex, MM
USC	SC—Ultra Polish, Simplex, SM
USF	SC—Ultra Polish, Duplex, SM
PST	ST—Physical Polish, Simplex, MM
UST	ST—Ultra Polish, Simplex, SM
AFC	FC—Angle Polish, Simplex, SM
PFC	FC—Physical Polish, Simplex, MM
UFC	FC—Ultra Polish, Simplex, SM
ADL	LC—Angle Polish, Duplex, SM
PLC	LC—Physical Polish, Simplex, MM
PDL	LC—Physical Polish, Duplex, MM
ULC	LC—Ultra Polish, Simplex, SM
UDL	LC—Ultra Polish, Duplex, SM



LightLink LANSystem 4RU Fiber Termination Patch Panel

The AFL 4RU Fiber Termination Patch Panel is designed for use as a rack mount interconnect point where termination and connectivity of up to 144 fibers is desired. The panel design is based on a 4 rack unit height with a master plate that is provisioned with 12 LGX® 118 compatible mounting positions that can accommodate adapter plates, XFM® optical cassettes, passive optical modules or any combination therein.

Standard 4RU Fiber Termination Patch Panels are available empty for complete field configuration, half loaded with adapter plates, or stubbed with a factory installed circular premise cable (CPC) or loose tube cable assembly.

Specifications

- Telcordia® GR-63 NEBS Tested
- Aluminum construction per ASTM B209
- Durable textured powder coat finish available in black or white
- Universal 19/23" EIA/TIA rack compatibility
- Standard density: up to 72-fiber
- High density: up to 144-fiber
- LGX 118 compatible
- Standard cable stub location is right rear exiting upward

Features

- Fits comfortably into new and existing interconnect, cross-connect, customer premise, and co-location environments
- Most common connector styles and types available
- Compatible with industry standard equipment frames
- LGX compatible master plate and footprint (118 mm)
- Modular design
- Provides maximum protection of optical components

Applications

- Telecommunications closets
- Data Centers
- Customer Premise
- LAN / WAN Networks
- Central Offices / Headends
- Hubs / Cabinets / Remote Terminals
- FTTH / FTTB Networks

Dimensions

DEPTH (A) IN INCHES	WIDTH (B) IN INCHES	HEIGHT (C) IN INCHES	RACK UNITS	FIBER CAPACITY	UNLOADED WEIGHT	MATERIAL GAUGE
11.00	17.00	7.00	4	72/96/144	9 lbs.	2.03 mm

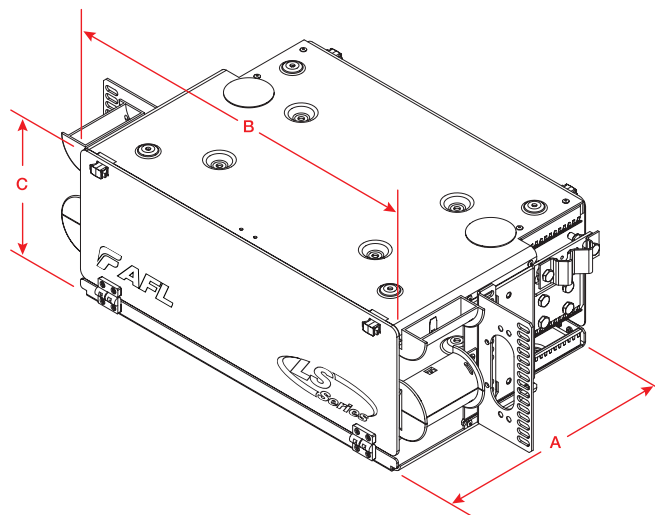

LGX is a registered trademark of Furukawa Electric North America, Inc.
Telcordia is a registered trademark of Telcordia Technologies, Inc.

LightLink LANSystem 4RU Fiber Termination Patch Panel

Ordering Information

Select the seven digit AFL panel part number, specify the color, and choose the loading character desired.

When ordering stubbed (S), enter the cable stub length required in meters.

Note: Standard stub is Circular Premise Cable (CPC).

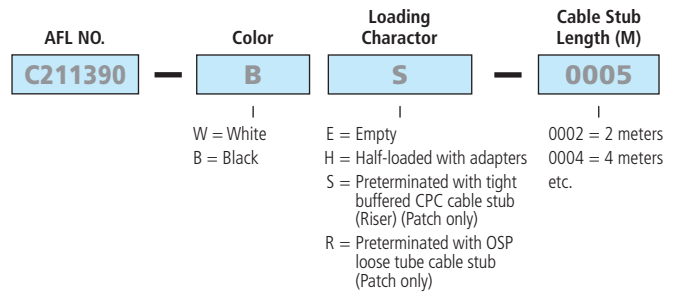

Example: Order number for a panel Black in color, loaded with 72 PSC adapters (12 six packs), connectors and a cable stub 5 meters in length.

Ordering Information

CONFIGURATION	AFL NO.
CON072P—4 RU PATCH PANELS—72 FIBERS—LGX118	
EMPTY	C211372
72 PSC adapters (12 Six Packs)	C211390
72 UST adapters (12 Six Packs)	C211417
72 PST adapters (12 Six Packs)	C211426
36 UDL (dup) adapters (12 Three Packs)	FM000191
36 PDL (dup) adapters (12 Three Packs)	FM000192
72 ASC adapters (12 Six Packs)	C213955
72 UFC adapters (12 Six Packs)	C213941
72 USC adapters (12 Six Packs)	C213952
72 AFC adapters (12 Six Packs)	C213946
36 PSF (dup) adapters (12 Three Packs)	FM000193
36 USF (dup) adapters (12 Three Packs)	FM000136
36 ASF (dup) adapters (12 Three Packs)	FM000194

CONFIGURATION	AFL NO.
CON096P—4 RU PATCH PANELS—96 FIBERS—LGX118	
EMPTY	FM000344
96 PSC adapters (12 Eight Packs)	FM000203
96 UST adapters (12 Eight Packs)	C213964
96 PST adapters (12 Eight Packs)	FM000204
96 ASC adapters (12 Eight Packs)	C213982
96 UFC adapters (12 Eight Packs)	C213970
96 USC adapters (12 Eight Packs)	C213977
96 AFC adapters (12 Eight Packs)	C213973

Notes:
 1) All MM cable is 62.5 μm unless otherwise specified.
 2) When ordering Empty Termination Patch/Splice Panel, accessories are available for field configuration.

Qualifications

GOVERNING BODY	STANDARD CODE
ASTM	ASTMB209
Telcordia	GR-63NEBS

CONFIGURATION	AFL NO.
CON144HD—4 RU HIGH DENSITY PATCH PANELS—144 FIBERS—LGX118	
EMPTY	FM000344
72 UDL (dup) adapters (12 Six Packs)	C211432
72 ADL (dup) adapters (12 Six Packs)	FM000345
72 PSF (dup) adapters (12 Six Packs)	C211396
72 PDL (dup) adapters (12 Six Packs)	C211439
72 USF (dup) adapters (12 Six Packs)	FM000196
72 ASF (dup) adapters (12 Six Packs)	FM000197
144 UST adapters (12 Twelve Packs)	FM000198
144 PST adapters (12 Twelve Packs)	FM000199
144 UFC adapters (12 Twelve Packs)	FM000200
144 USC adapters (12 Twelve Packs)	FM000133
144 ASC adapters (12 Twelve Packs)	FM000201

Connector/Adapter Key

TYPE	DESCRIPTION
ASC	SC—Angle Polish, Simplex, SM
ASF	SC—Angle Polish, Duplex, SM
PSC	SC—Physical Polish, Simplex, MM
PSF	SC—Physical Polish, Duplex, MM
USC	SC—Ultra Polish, Simplex, SM
USF	SC—Ultra Polish, Duplex, SM
PST	ST—Physical Polish, Simplex, MM
UST	ST—Ultra Polish, Simplex, SM
AFC	FC—Angle Polish, Simplex, SM
PFC	FC—Physical Polish, Simplex, MM
UFC	FC—Ultra Polish, Simplex, SM
ADL	LC—Angle Polish, Duplex, SM
PLC	LC—Physical Polish, Simplex, MM
PDL	LC—Physical Polish, Duplex, MM
ULC	LC—Ultra Polish, Simplex, SM
UDL	LC—Ultra Polish, Duplex, SM

Xpress Fiber Management® (XFM®) 4RU Patch Panel



The Xpress Fiber Management (XFM) 4RU patch panel is a rack mountable interconnect point specifically designed to manage dense fiber applications. Based on the LGX® intermateability platform, the panel is fully compatible with AFL's XFM Optical Cassette, Poli-MOD® and WDM solutions, offering enhanced management of densities up to 288F using MTP/MPO, single fiber, or patch and splice methodologies. Routing rings on the top and bottom of the front panel provide enhanced cable routing allowing cable assemblies to exit comfortably. This panel can be provisioned with a key lock at the time of order for secure environments.

Features

- Aluminum construction
- Textured black powder coat finish
- Universal WECO/TIA 19"/23" rack compatibility
- (12) LGX 118 adapter plate / module mounting positions
- Mounting depth adjustable from flush to 8" in 1" increments

Applications

- Data Centers
- Enterprise Networks
- Telecommunications Closets
- Central Offices / Headends

Specifications

DEPTH (A) IN INCHES	FRONT WIDTH (B) IN INCHES	REAR WIDTH (C) IN INCHES	HEIGHT (D) IN INCHES	RACK UNITS	CAPACITY	UNLOADED WEIGHT
15.5	17	15	7	4	(12) LGX 118	9 lbs.

Ordering Information

DESCRIPTION	MODEL NO.	AFL NO.
Xpress Fiber Management 4U Patch Panel, Black, Empty	XFM-4U-B-0	FM001090-B
Xpress Fiber Management 4U Patch Panel, Black, Empty, Key Lock	XFM-4U-B-K	FM001218-B

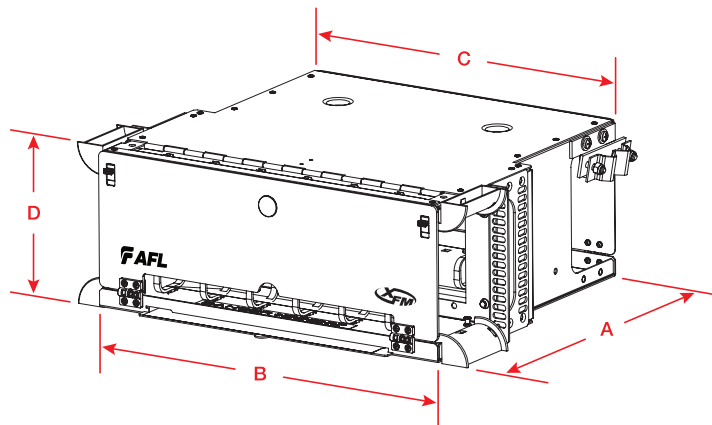

LGX is a registered trademark of Furukawa Electric North America, Inc.



LL-500 with interconnect kit installed



LL-500 with LL-2450 splice tray installed

LightLink 500 Optical Splicing and Distribution Enclosure

The LightLink (LL) 500 Optic Splicing and Distribution Enclosure provides for organizing, splicing and interconnecting fibers in broadband, distribution and building entrance applications. The enclosure features a scratch and corrosion resistant powder paint coating base and a fully gasketed hinged cover. A unique self-sizing grommet design allows for express and pre-terminated cable installation. The LL-500 supports up to five LL-2450 splice trays for up to 60 single fusion splices or three LL-4850 splice trays (not included in base unit) and an optional 12 fiber, hinged Interconnect Module.

Features

- Independent cable strain relief system
- Cable entry/exit grommet seals
- Fiber routing system
- Splice tray support system
- Hinged cover
- Supports optional Interconnect Modules
- Interconnect Module supports up to 12 SC bulkhead adapters
- Secured with a standard padlock
- 4 cable ports with standard grommets
- 8 cable ports with optional expansion kits

Specifications

PARAMETER	VALUE
Material	Steel
Coatings	Electrostatically applied, powder coat
Color	Antique white
Cable Ports	4-8
Cable Sizes (Max. O.D. – Min. O.D.)	4 @ 0.3-0.77" Up to 8 with Dual Grommet Kits 4 @ 0.3-0.65" 4 @ 0.3-0.5"
Dimensions (H x W x D) in. (cm)	17.5 x 9.0 x 4.0 (44.45 x 22.86 x 10.16)
Weight lbs. (kg)	6.5 (2.95)

Ordering Information

DESCRIPTION	AFL NO.
LL-500-U-0	FM000326
LL-500 Interconnect Kit with SC UPC adapters	FM000385
LL-500 Interconnect Kit with SC APC adapters	FM000407
LL-500 Interconnect Kit without adapters	FM000408
LL-500 with Multi-port Grommets	FM000659
LL-2450 Single Fusion Splice Tray (stores 12 single fusion splices)	91957-00
LL-4850 Mass Fusion Splice Tray (stores 8 mass fusion sleeves - 96 fibers)	91958-00
LL-500 Multi-port Grommet Kit, 6 drop cable entry up to 0.37" OD	FC000573

Qualifications

GOVERNING BODY	STANDARD CODE
NEMA	Type 3

Contact AFL for further details.



Shown with four SC/APC adapters, security cover and grounding



"U-Grommet" Entry Option



1/2" Hole Entry Option

OptiNID® Duo Optical Demarcation Enclosure

AFL's OptiNID (OPN) Duo Optical Demarcation Enclosure is the latest entry in the OptiNID fiber optic demarcation family of products. The ultra-compact OPN Duo is designed with flexibility in mind with the capability to house up to 4 SC simplex or LC duplex adapters, along with the ability to house up to 18 single fiber or 6 mass fusion splices. The OPN Duo is also optimized for the use of AFL's FASTConnect® or FUSEConnect® field-installable connectors. The base of the enclosure houses an insert which incorporates fiber routing, splice tray, adapter plate, and cable retention features. The OPN Duo also has several optional features such as a clear splice/security cover for protecting provider-side connectors or a grounding plate for grounding armored or toneable drop cables. The OPN Duo is available with two different base cable entry options, either a pair of U-shaped "drop-in" style grommets, or two half-inch ports allowing for a variety of different entry accessories.

Features

- Integrated splice tray for up to 18 single fusion splices or 6 mass fusion
- Optional clear splice/security cover covers splices, pigtails and provider-side connectors
- Snap lock cover with optional 3/8" screw for added security
- "U-Grommets" provide easy drop-in cable entry or two half-inch ports for a variety of cable entry options
- Integrated mounting points external to the enclosure allow mounting to walls or poles without drilling holes through the box, creating leak paths

Applications

- FTTx – Fiber-to-the-Home (single family, multi-dwelling), Fiber-to-the-Business (multi-tenant)
- Wireless – Macro and small cell

Specifications

PARAMETER	VALUES
Dimensions – H x W x D	9.6 x 7.0 x 2.7 inches (24.4 x 17.7 x 6.8 cm)
Material	UL® listed flame retardant thermoplastic alloy
UV Resistance (Days Exposed)	60 per ASTM-G26-84
Flammability	UL94-5VA
Impact Test	-40°F (-40°C), 10 ft-lbs. on all external surfaces
Chemical Resistance 30 Days at 100°F and 95% RH	Resists chipping and/or cracking when subject to house paint, wasp spray, sulfuric acid, kerosene and sodium hydroxide
Drop Test	-40°F (-40°C), 3 ft. onto concrete surface 4 times
Rain	24 hours at 10 psi
Temperature Cycling with Humidity	30 day cycling from -40°F to 149°F (-40°C to 65°C) with 95% RH

continued
→

OptiNID® Duo Optical Demarcation Enclosure

Ordering Information

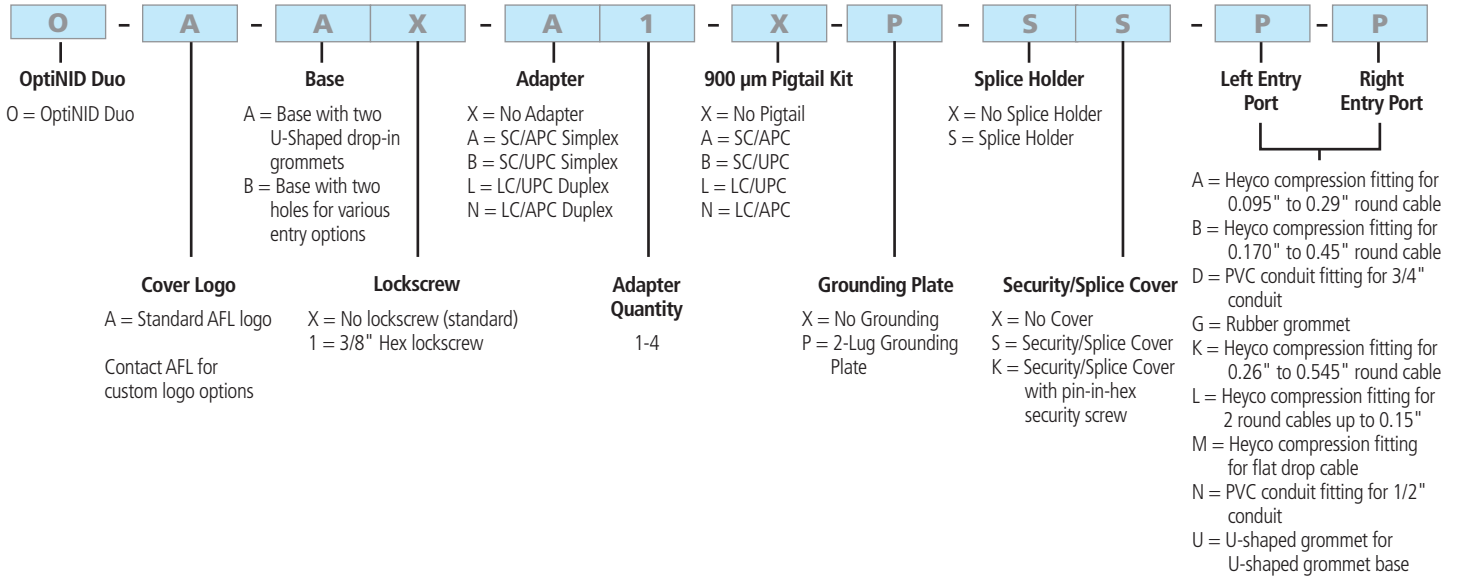

Ordering Information – Accessories

DESCRIPTION	AFL NO.
OptiNID Duo Splice Module, Pack of 20	AX-TRAY-MOD-20

NOTE: Options A-N available with the two-hole entry option only

Dimensions (in inches)

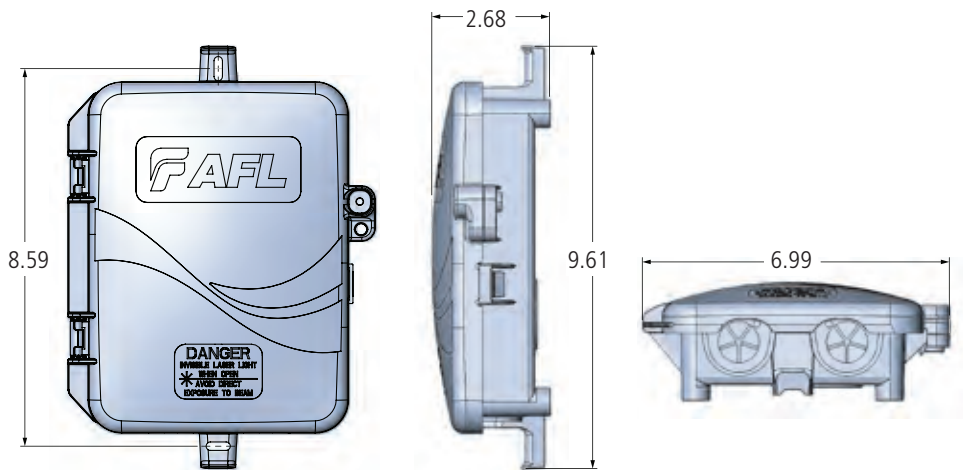

Qualifications

GOVERNING BODY	STANDARD CODE
Telcordia	GR-49, GR-2898

Contact AFL for further details.

OptiNID® 760XL Optical Demarcation Closure

The OptiNID (OPN) 760XL is an optical demarcation closure designed for use in either indoor or outdoor environments. It is capable of housing up to 24 bulkhead adapters in two 118 LGX® compatible adapter plates and is equipped with a splice tray (LL-2425), which holds up to 32 single fusion splices. The OPN-760XL can be either wall or pole-mounted.

Features

- Capacity for up to two 118 LGX compatible adapter plates
- Rugged weather-resistant thermoplastic alloy
- Self-latching, hinged cover design allows easy access without loose parts
- Slip-in grommets allow pre-connectorized cable deployment
- Provider override is provided so that technician can override customer lock
- Security cover option available

Specifications

PARAMETER	VALUES
Dielectric Strength	Minimum 2500 Vrms for 1 minute
High Temperature Storage/Mold Stress	14 days at 159°F (70.55 °C)
Temperature Cycling with Humidity	150 day cycling from 40-140°F (4.44-60°C) with 95% RH
Impact Test	-40°F (-40°C), 5*/lbs on all external surfaces
Drop Test	-40°F (-40°C), 5* (12.7 cm) onto concrete surface 4 times
Rain	24 hours at 10 psi
UV Resistance (Days Exposed)	60 per ASTM-G26-84
Salt Fog (Days Exposed)	60 per ASTM-BLL7-90
Flammability	UL94-5V
Chemical Resistance 30 Days at 100 °F and 95% RH Subject to:	Resists chipping and/or cracking when subject to: house paint, wasp spray, sulfuric acid, kerosene and sodium hydroxide
Material	UL® listed flame retardant thermoplastic alloy
Dimensions (H x W x D) in. (cm)	13 x 13 x 3.75 (32.5 x 32.5 x 9.5)
Cable Entrances in. (cm) diameter—Input	4 x 0.875 (2.2)—3/4" conduit
Covers	Standard – molded-in snap finger and 3/8" hex head fastener



OPN-760XL with optional security cover kit



OPN-760XL with 3/4" Pipe Fitting Transition Kit



3/4" Pipe Fitting Transition Kit

Ordering Information

DESCRIPTION	AFL NO.
BASE PRODUCT ^{1,2}	
OptiNID OPN-760XL, No Adapters, No Security Cover	DM001000
OptiNID OPN-760XL, No Adapters, Security Cover	DM001022
ACCESSORIES ³	
3/4" Pipe Fitting Transition Kit (includes 2)	DM001174
OPN-760XL Security Cover Kit	DM000923
OPN-760XL Pole Mounting Kit	DM000927

Notes:

1. All standard OPN-760XL configurations come equipped with four slip-in rubber grommets and a splice tray equipped for 32 single fusion splices.
2. Contact AFL customer service for additional configurations.
3. See OptiNID Accessory Page for additional kits.



OptiNID® 500 Optical Demarcation Closure

The OptiNID (OPN) 500 is an optical demarcation closure designed for use in either indoor or outdoor environments. Small form factor for FTTH demarcation applications, the closure is capable of housing up to six bulkhead adapters in one 118 LGX® compatible adapter plate, and is equipped with an integrated splice tray, which holds up to six single fusion splices. The OPN-500 can be either wall or pole-mounted.

Features

- Weather-resistant thermoplastic alloy
- Self-latching, hinged cover design allows easy access without loose parts
- Capacity for one 118 LGX compatible adapter plate
- Provider override for customer lock
- 3/4" NPT conduit fitting, compression cable fittings or grommeted entry ports

Specifications

PARAMETER	VALUES
Dielectric Strength	Minimum 2500 Vrms for 1 minute
Impact Test	-40°F (-40°C), 5 ft.-lbs on all external surfaces
Drop Test	-40°F (-40°C), 5 ft onto concrete surface four times
Rain	24 hours at 10 psi
UV Resistance (Days Exposed)	60 per ASTM-G26-84
Salt Fog (Days Exposed)	60 per ASTM-BLL7-90
Flammability	UL94-5V
Chemical Resistance 30 Days at 100°F and 95% RH	Resists chipping and/or cracking when subject to house paint, wasp spray, sulfuric acid, kerosene and sodium hydroxide
Material	UL® listed flame retardant thermoplastic alloy
Dimensions (H x W x D) in. (cm)	6.3 x 7.8 x 2.0 (15.7 x 19.7 x 5.0)
Cable Entrance in. (cm) diameter - Input	1 x 3/4" NPT (1.130"), 2 x 1/2" NPT (0.875")
Covers	Standard, molded-in snap finger and "F" termination
Operating Temperature Range – °F (°C)	-40 to 140 (-40 to 60)

Ordering Information

DESCRIPTION	AFL NO.
BASE PRODUCT ^{1,2}	
OptiNID OPN-500, No Adapters	DM001021
OptiNID OPN-500, 1 x SC/UPC Adapter	DM000550
OptiNID OPN-500, 1 x SC/APC Adapter	DM000766
OptiNID OPN-500, 6 x SC/UPC Adapters	DM000871
OptiNID OPN-500, 6 x SC/UPC Adapters, 6 x 1 m 900 μm Pigtaills	DM001109
ACCESSORIES ³	
Heyco M3234 Compression Fitting, 18 mm to 11 mm Grip (includes 4) – Left Port Only	DM001171
Kit, Six-Position Splice Chip, (includes 10)	DM000870

Notes:

1. All standard OPN-500 configurations come equipped with a 3/4" NPT fitting, rubber grommet and Heyco 3231 compression fitting, along with a splice chip for six single fusion splices.
2. Contact AFL customer service for additional configurations.
3. See OptiNID Accessory Page for additional kits.

LGX is a registered trademark of Furukawa Electric North America, Inc.

OptiNID® Optical Demarcation Accessories

Heyco Compression Fittings for OPN-300 Series and OPN-500



Used on the bottom entry ports of the OPN-300 Series and OPN-500 for a tight compression fitting. The Heyco M3234 fits into the larger left port and can compress from 18 mm to 11 mm in port size. The Heyco M3231 fits into the smaller middle and right ports and can compress from 11 mm to 4 mm. Kits include nylon locknuts.

Ordering Information

DESCRIPTION	AFL NO.
Heyco M3234 Compression Fitting, 18 mm to 11 mm Grip (includes 4). Left Port Only	DM001171
Heyco M3231 Compression Fitting, 11 mm to 4 mm Grip (includes 4). Middle and Right Port	DM000911

NPT Conduit Fittings for OPN-300 Series and OPN-500



Used on the bottom entry ports of the OPN-300 series and OPN-500 as an open port or to accept NPT conduit. The 3/4" NPT fitting has a through-hole size of 0.71" and can accept 3/4" NPT conduit. The 1/2" NPT fitting has a through-hole size of 0.51" and can accept 1/2" NPT conduit. Kits include nylon locknuts.

Ordering Information

DESCRIPTION	AFL NO.
3/4" NPT Conduit Fitting (includes 4) – Left Port Only	DM001170
1/2" NPT Conduit Fitting (includes 4) – Middle and Right Port	DM000912

Rubber Grommet for OPN-300 Series and OPN-500



Used on the middle and right entry ports of the OPN-300 series and OPN-500. The rubber grommets can be easily inserted to create a grommetted entry port or to seal an unused port.

Ordering Information

DESCRIPTION	AFL NO.
Rubber Grommet, 0.875" (includes 10)	DM001119

continued
→

Opti-NID® Optical Demarcation Accessories

Fiber Demarcation



Splice Chip Kit for OPN-500

Used on the OPN-500 to add an additional splice chip to the splice area to increase the splice capacity to 12 single fusion splices. The chip has an adhesive back, allowing it to adhere to multiple locations within the box.

Ordering Information

DESCRIPTION	AFL NO.
Kit, Six-Position Splice Chip (includes 10)	DM000870



Pipe Transition Kit for OPN-760XL

Used on the OPN-760XL to create a 3/4" NPT transition fitting. The fitting slides into any of the four entry ports on the OPN-760XL and securely clips into place. The 3/4" NPT fitting has a through-hole size of 0.67" and can accept 3/4" NPT conduit.

Ordering Information

DESCRIPTION	AFL NO.
3/4" Pipe Fitting Transition Kit (includes 2)	DM001174



Security Cover Kit for OPN-760XL

Used on the OPN-760XL to create a lockable security cover for provider access. The cover fits over the back portion of the OPN-760XL, covering the splice tray and provider side of the adapters and locks into place with a star head bolt.

Ordering Information

DESCRIPTION	AFL NO.
OPN-760XL Security Cover Kit	DM000923



Pole Mounting Kit for OPN-760XL

Used on the OPN-760XL to provide an easy pole mounting solution. The plate mounts to the back of the OPN-760XL and provides arms for straps or bolts to adhere to a pole.

Ordering Information

DESCRIPTION	AFL NO.
OPN-760XL Pole Mounting Kit	DM000927

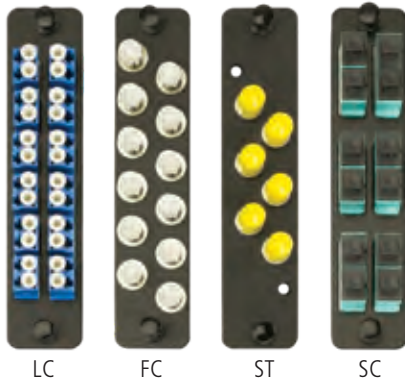

LightLink Adapter Plates

LightLink Adapter Plates add versatility to AFL's panel product line. Adapter plates are compatible with industry standard platforms allowing for easy upgrades to existing panels. Adapter Plates come preloaded with adapters and are available in 6, 8, 12 and 24 pack versions for single-fiber adapters. Higher fiber counts are achievable with multi-fiber adapters. Blank plates are also available for unused space in panels.

Features

- Metal Plate with Nylatches
- Polyurethane powder coated (white or black)
- LGX® compatible

Specifications

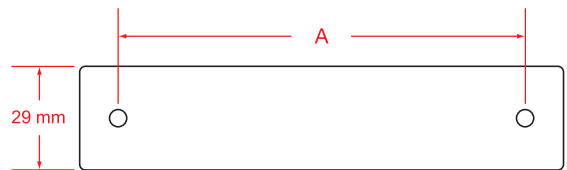

DIMENSION A
118 mm LGX®
170 mm LGX®

Ordering Information

AFL NO.	ADAPTER TYPE	SIMPLEX/DUPLEX/QUAD	ADAPTER COLOR	FIBER COUNT	PLATE HEIGHT	PLATE COLOR
BLANK						
FM003072	BLANK	BLANK	NA	0	LGX (118)	BLACK
FM003462	BLANK	BLANK	NA	0	LGX (118)	WHITE
FM000343	BLANK	BLANK	NA	0	LGX (118)	SMOOTH BLACK
FM003434	BLANK	BLANK	NA	0	LGX (170)	BLACK
FM003433	BLANK	BLANK	NA	0	LGX (170)	WHITE
SC						
FM003295	SC	DUPLEX	AQUA	12F	LGX (118)	BLACK
FM002272	SC	DUPLEX	AQUA	12F	LGX (118)	WHITE
FM003293	SC	DUPLEX	BEIGE	12F	LGX (118)	BLACK
FM002273	SC	DUPLEX	BEIGE	12F	LGX (118)	WHITE
FM003301	SC	DUPLEX	BLACK	12F	LGX (118)	BLACK
FM003297	SC	DUPLEX	BLUE	12F	LGX (118)	BLACK
FM002271	SC	DUPLEX	BLUE	12F	LGX (118)	WHITE
FM002633	SC	DUPLEX	GREEN	12F	LGX (118)	BLACK
FM002634	SC	DUPLEX	GREEN	12F	LGX (118)	WHITE
FM000149	SC	DUPLEX	BEIGE	12F	LGX (170)	WHITE
FM000148	SC	DUPLEX	BEIGE	12F	LGX (170)	BLACK
FM000144	SC	DUPLEX	BLUE	12F	LGX (170)	BLACK
FM000145	SC	DUPLEX	BLUE	12F	LGX (170)	WHITE
FM000152	SC	DUPLEX	GREEN	12F	LGX (170)	BLACK
FM000153	SC	DUPLEX	GREEN	12F	LGX (170)	WHITE
FM003287	SC	DUPLEX	AQUA	6F	LGX (118)	BLACK
FM003285	SC	DUPLEX	BEIGE	6F	LGX (118)	BLACK
FM003398	SC	DUPLEX	BEIGE	6F	LGX (118)	WHITE
FM003299	SC	DUPLEX	BLACK	6F	LGX (118)	BLACK
FM003289	SC	DUPLEX	BLUE	6F	LGX (118)	BLACK
FM003458	SC	DUPLEX	BLUE	6F	LGX (118)	WHITE
FM003283	SC	DUPLEX	GREEN	6F	LGX (118)	BLACK
FM000115	SC	DUPLEX	GREEN	6F	LGX (118)	WHITE

LGX is a registered trademark of Furukawa Electric North America, Inc.

LightLink Adapter Plates

Ordering Information (cont.)

AFL NO.	ADAPTER TYPE	SIMPLEX/DUPLEX/ QUAD	ADAPTER COLOR	FIBER COUNT	PLATE HEIGHT	PLATE COLOR
SC						
FM003120	SC	SIMPLEX	AQUA	12F	LGX (118)	BLACK
FM003118	SC	SIMPLEX	BEIGE	12F	LGX (118)	BLACK
FM003242	SC	SIMPLEX	BLACK	12F	LGX (118)	BLACK
FM003122	SC	SIMPLEX	BLUE	12F	LGX (118)	BLACK
FM002842-TW	SC	SIMPLEX	BLUE	12F	LGX (118)	WHITE
FM003116	SC	SIMPLEX	GREEN	12F	LGX (118)	BLACK
FM000800-TW	SC	SIMPLEX	GREEN	12F	LGX (118)	WHITE
FM003411	SC	SIMPLEX	BEIGE	12F	LGX (170)	WHITE
FM003409	SC	SIMPLEX	BLUE	12F	LGX (170)	BLACK
FM003407	SC	SIMPLEX	BLUE	12F	LGX (170)	WHITE
FM003414	SC	SIMPLEX	GREEN	12F	LGX (170)	BLACK
FM003455	SC	SIMPLEX	GREEN	12F	LGX (170)	WHITE
FM003098	SC	SIMPLEX	AQUA	6F	LGX (118)	BLACK
FM003096	SC	SIMPLEX	BEIGE	6F	LGX (118)	BLACK
FM003403	SC	SIMPLEX	BEIGE	6F	LGX (118)	WHITE
FM003238	SC	SIMPLEX	BLACK	6F	LGX (118)	BLACK
FM003100	SC	SIMPLEX	BLUE	6F	LGX (118)	BLACK
FM003467	SC	SIMPLEX	BLUE	6F	LGX (118)	WHITE
FM003094	SC	SIMPLEX	GREEN	6F	LGX (118)	BLACK
FM000480	SC	SIMPLEX	GREEN	6F	LGX (118)	WHITE
FM000156	SC	SIMPLEX	BLUE	8F	LGX (118)	BLACK
FM003435	SC	SIMPLEX	BLUE	8F	LGX (118)	WHITE
FM002841	SC	SIMPLEX	GREEN	8F	LGX (118)	BLACK
FM000158	SC	SIMPLEX	GREEN	8F	LGX (118)	WHITE
LC						
FM001004	LC	DUPLEX	GREEN	12F	LGX (118)	WHITE
FM001303	LC	DUPLEX	AQUA	12F	LGX (118)	WHITE
FM003108	LC	DUPLEX	GREEN	12F	LGX (118)	BLACK
FM003110	LC	DUPLEX	BEIGE	12F	LGX (118)	BLACK
FM003112	LC	DUPLEX	AQUA	12F	LGX (118)	BLACK
FM001185	LC	QUAD	AQUA	12F	LGX (118)	BLACK
FM000297	LC	DUPLEX	BLUE	12F	LGX (170)	WHITE
FM000298	LC	DUPLEX	BLUE	12F	LGX (170)	BLACK
FM000301	LC	DUPLEX	GREEN	12F	LGX (170)	WHITE
FM000302	LC	DUPLEX	GREEN	12F	LGX (170)	BLACK
FM000838	LC	DUPLEX	BLUE	24F	LGX (118)	WHITE
FM000851	LC	DUPLEX	BEIGE	24F	LGX (118)	WHITE
FM000853	LC	DUPLEX	AQUA	24F	LGX (118)	WHITE
FM003069	LC	DUPLEX	GREEN	24F	LGX (118)	WHITE
FM001184	LC	QUAD	AQUA	24F	LGX (118)	BLACK
FM000129	LC	DUPLEX	BLUE	24F	LGX (170)	WHITE
FM000130	LC	DUPLEX	BLUE	24F	LGX (170)	BLACK
FM000338	LC	DUPLEX	GREEN	24F	LGX (170)	WHITE
FM000339	LC	DUPLEX	GREEN	24F	LGX (170)	BLACK
FM000348	LC	DUPLEX	BEIGE	24F	LGX (170)	WHITE
FM000349	LC	DUPLEX	BEIGE	24F	LGX (170)	BLACK
FM000289	LC	DUPLEX	BLUE	6F	LGX (118)	WHITE
FM000293	LC	DUPLEX	GREEN	6F	LGX (118)	WHITE
FM000294	LC	DUPLEX	GREEN	6F	LGX (118)	BLACK
FM003092	LC	DUPLEX	BLUE	6F	LGX (118)	BLACK
FM003429	LC	DUPLEX	BEIGE	6F	LGX (118)	WHITE
FM004252	LC	DUPLEX	AQUA	6F	LGX (118)	BLACK

LightLink Adapter Plates

Ordering Information (cont.)

AFL NO.	ADAPTER TYPE	SIMPLEX/DUPLEX/ QUAD	ADAPTER COLOR	FIBER COUNT	PLATE HEIGHT	PLATE COLOR
LC						
FM003240	LC	DUPLEX	BLACK	12F	LGX (118)	BLACK
FM003425	LC	DUPLEX	BLUE	12F	LGX (118)	WHITE
FM003465	LC	DUPLEX	BLUE	12F	LGX (118)	BLACK
FM003202	LC	DUPLEX	GREEN	24F	LGX (118)	BLACK
FM003204	LC	DUPLEX	BEIGE	24F	LGX (118)	BLACK
FM003206	LC	DUPLEX	AQUA	24F	LGX (118)	BLACK
FM003208	LC	DUPLEX	BLUE	24F	LGX (118)	BLACK
FM003244	LC	DUPLEX	BLACK	24F	LGX (118)	BLACK
ST						
FM003126	ST	SIMPLEX	METAL SM/MM	12F	LGX (118)	BLACK
FM003456	ST	SIMPLEX	METAL SM/MM	12F	LGX (118)	WHITE
FM000286	ST	SIMPLEX	METAL SM/MM	12F	LGX (170)	BLACK
FM000285	ST	SIMPLEX	METAL SM/MM	12F	LGX (170)	WHITE
FM003104	ST	SIMPLEX	METAL SM/MM	6F	LGX (118)	BLACK
FM003422	ST	SIMPLEX	METAL SM/MM	6F	LGX (118)	WHITE
FM003102	ST	SIMPLEX	METAL SM/MM	6F	LGX (118)	BLACK
FM003441	ST	SIMPLEX	METAL SM/MM	8F	LGX (118)	BLACK
FM003439	ST	SIMPLEX	METAL SM/MM	8F	LGX (118)	WHITE
FC						
FM000284	FC	SIMPLEX	METAL	12F	LGX (118)	BLACK
FM000283	FC	SIMPLEX	METAL	12F	LGX (118)	WHITE
FM003447	FC	SIMPLEX	METAL	12F	LGX (170)	BLACK
FM003446	FC	SIMPLEX	METAL	12F	LGX (170)	WHITE
FM003420	FC	SIMPLEX	METAL, GREEN DUST CAP	6F	LGX (118)	BLACK
FM003419	FC	SIMPLEX	METAL, GREEN DUST CAP	6F	LGX (118)	WHITE
FM003443	FC	SIMPLEX	METAL	8F	LGX (118)	BLACK
FM003442	FC	SIMPLEX	METAL	8F	LGX (118)	WHITE
MISC						
FM003210	HEYCO	SIMPLEX	BLACK	12F	LGX (118)	BLACK
FM003430	MTP	SIMPLEX	BLACK	36F	LGX (118)	BLACK
FM003212	HEYCO	SIMPLEX	BLACK	6F	LGX (118)	BLACK
FM003437	SC-ST HYBRID	SIMPLEX	BLUE-METAL	6F	LGX (118)	WHITE
FM001606	MTP	SIMPLEX	BLACK	72F	LGX (118)	BLACK
FM003005	MTP	SIMPLEX	BLACK	96F	LGX (118)	BLACK

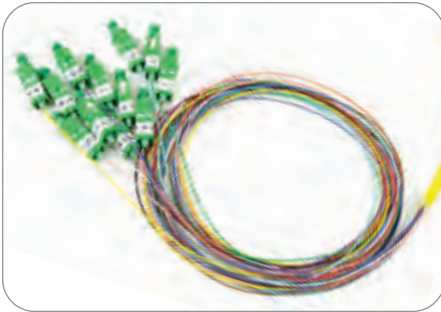

Pigtail Assemblies for Patch and Splice Panels

AFL's pigtail assemblies help eliminate labor-intensive field termination, yet guarantee reliable performance. Featuring a unified construction allowing for easy fiber identification and rapid installation, these assemblies are built to exceed all TIA and Telcordia® requirements.

Ordering Information

POLISH	FIBER TYPE	CONNECTOR INTERFACE AFL NO.		
		SC	ST	LC
CPC PIGTAIL KITS, 3 METER, 12-FIBER				
APC	SMF	C152906-0003	—	CS007719-0003
UPC	SMF	C165943-0003	C152671-0003	C223369-0003
PC	62.5 μm	C165463-0003	C223366-0003	C223373-0003
PC	50 μm LO	CS007673-0003	CS007675-0003	CS007677-0003

900 μm TIGHT-BUFFERED PIGTAIL KITS, 3 METER, 12-FIBER				
APC	SMF	C223312-0003	—	CS002951-0003
UPC	SMF	C223492-0003	CS003979-0003	CS001037-0003
PC	62.5 μm	CS000386-0003	CS002150-0003	CS002067-0003
PC	50 μm LO	CS003056-0003	CS003980-0003	CS003058-0003

Specifications

PARAMETER		VALUE					
		LC	SC	ST	FC	LC-APC	SC-APC
Insertion Loss							
SM	MAX	0.3	0.3	0.5	0.3	0.3	0.5
MM	MAX	0.5	0.5	0.5	0.5		
Return Loss							
SM	MIN	-55.0 dB	-55.0 dB	-55.0 dB	-55.0 dB	-65.0 dB	-65.0 dB
MM	MIN	-20.0 dB					
Cable Bend Radius							
Bend Insensitive	MIN	<15 mm					
Operating Temperature		0°C to +70°C					

Qualifications

GOVERNING BODY	STANDARD CODE	COMPONENT
Telcordia	GR-409	Cable
TIA	GR-326	Connector
ITU	G.652-D, G.657-A1	Single-mode Optical Fiber Only

Telcordia is a registered trademark of Telcordia Technologies, Inc.

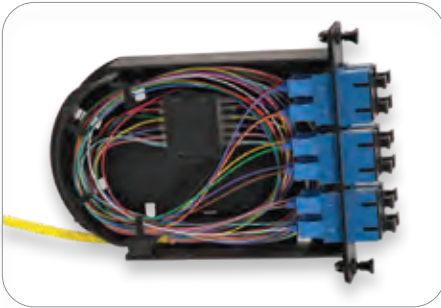

12-Fiber SC/UPC Configuration



24-Fiber LC/UPC Configuration



DAS Poli-MOD



Poli-MOD® Patch and Splice Module

AFL's new Poli-MOD is an innovative patch and splice module, which offers an inventive and effective means to accommodate up to 24 fiber interconnections in an industry-standard, single-slot LGX® 118 footprint. The new Poli-MOD offers a unique and robust way to secure cable without the need for time-wasting, tie-wrap alternatives. Additionally, the module leverages a creative snap-in splice sleeve cradle to securely manage both single and ribbon fiber arrangements. These features provide the capacity to outfit a standard 4RU rack-mount panel with up to 288-fiber interconnections.

The Poli-MOD is also offered in an arrangement that supports the low loss budget requirements of Distributed Antenna System (DAS) networks. This is accomplished through the elimination of an interconnection point while providing a robust splicing environment for rack and wall-mount panel applications.

Features

- 24-fiber interconnection capacity
- LGX 118 compatibility (single-slot module)
- Effective and time-saving cable mounting mechanism (no tie-wraps necessary)
- Inventive splice sleeve cradle
- Available in SC, LC, ST and FC connector arrangements
- Shuttered LC connectors for increased dust protection
- Organized fiber routing
- Fixed solution, no moving parts
- Multi-directional cable entry access
- DIN rail mountable (with DIN Mount Kit)

Applications

- Telecommunications Closets
- Data Centers
- Customer Premise
- Local Area Networks
- Wide Area Networks
- Central Offices
- Hub Sites
- Cabinets
- Remote Terminals
- Distributed Antenna Systems (DAS)

LGX is a registered trademark of Furukawa Electric North America, Inc.

Poli-MOD® Patch and Splice Module

Ordering Information

Example: PM-L-12-ASC-0-S-01

PM	L	12	ASC	0	S	01
	Configuration	Fiber/Connector Count	Connector Type ³	Fiber Type	Fiber Arrangement	Packaging
	E = Empty (Splicing Only) H = Half Loaded (Adapter Plate only) L = Loaded (Adapter Plate & Pigtails) D = DAS Poli-MOD ¹	06 = 6 Fibers/Connectors 12 = 12 Fibers/Connectors 24 = 24 Fibers/Connectors ² XX = Empty	ASC = Angle-Polished SC USC = Ultra-Polished SC PSC = Multimode SC ALC = Angle-Polished LC ULC = Ultra-Polished LC PLC = Multimode LC UST = Ultra-Polished ST PST = Multimode ST AFC = Angle-Polished FC UFC = Ultra-Polished FC PFC = Multimode FC XXX = Empty	0 = Single-mode (G.657.A1 BIF) 1 = 62.5 μm (OM1) 2 = 50 μm (OM2) 3 = 50 μm (OM3) 4 = 50 μm (OM4) X = Empty	S = Single/Standard R = Ribbon 3 = 3 mm, 3 meter DAS W = SpiderWeb Ribbon® (SWR®) X = No Fiber (Half Loaded or Empty)	01 = 1 Poli-MOD per box* 06 = 6 Poli-MODs per box 12 = 12 Poli-MODs per box

1. DAS Poli-MOD requires specialty packaging and is packaged as "1 Poli-MOD per box" ONLY.
2. 24 Fibers/Connectors are only available in a LC Duplex configuration.
3. Angle and Ultra-Polished connector types are only available with single-mode fiber configurations.

Adapter Color Codes

FIBER AND POLISH TYPE	ADAPTER COLOR
Single-mode, APC (Angled Physical Contact)	Green
Single-mode, UPC (Ultra Physical Contact)	Blue
Multimode OM1, PC (Physical Contact)	Beige
Multimode OM2, PC (Physical Contact)	Black
Multimode OM4, PC (Physical Contact)	Aqua

Poli-MOD Kits/Accessories

DESCRIPTION	AFL NO.
Poli-MOD Cable Mounting Clip Kit	FM003053
Poli-MOD Spiral Wrap Kit	FM003280
Poli-MOD Splice Chip Kit with 24 Splice Sleeves	FM003711
Fusion Splice Sleeve, FP-03, 40 mm	S000206
Adapter Bracket for Mounting Single Poli-MOD, angled	FM000948-B
Adapter Bracket for Mounting Single Poli-MOD, flat	FM003589-B
Corning CCH and PCH 145 mm Adapter Bracket	FM001636
DIN Mount Kit, LGX® 118	FM003394

Dimensions

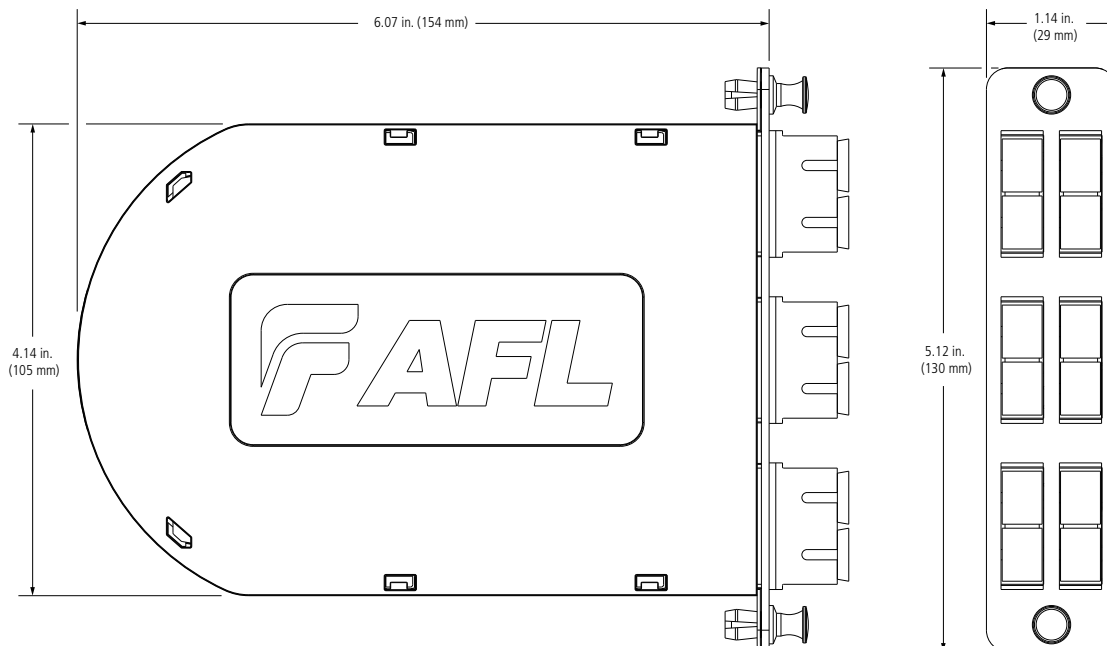



Field Master® Field-Installable Connectors

Field Master Connectors, for field-termination of fiber optics, feature high-precision, high-reliability and low-applied connector cost. Durable metal components, industry-standard connector designs, and proven crimp technology give the customer peace-of-mind that their installed network is steady and reliable. Field Master Tool Kits come complete with all necessary tools and consumables for the professional installation of Field Master Connectors.

Features

- High-precision ceramic ferrules ensure fiber alignment and repeatable performance
- Rugged metal connector bodies provide sturdy cable terminations
- Industry standard interfaces allow interoperability with media equipment
- Field proven crimp technology improves connector/cable tensile performance

Applications

- Premise environments
- Desk for LAN environments
- Patch panels
- Direct equipment termination
- Fiber to the Subscriber (FTTx) applications
- Repair/replacement requirements

Ordering Information

CONNECTOR	FIBER TYPE	BOOT COLOR	AFL NO.*
SC Field Master Connector (900 µm boot)	Multimode	Black	CS000308
SC Field Master Connector (3.0 mm boot)	Multimode	Beige	CS000309
SC Field Master Connector (900 µm & 3.0 mm boot)	Multimode	Black /Beige	CS005144
SC Field Master Connector (900 µm boot)	Single-mode	Blue	CS000310
SC Field Master Connector (3.0 mm boot)	Single-mode	Blue	CS000311
SC Field Master Connector (900 µm & 3.0 mm boot)	Single-mode	Blue	CS005145
ST Field Master Connector (900 µm boot)	Multimode	Black	CS000316
ST Field Master Connector (3.0 mm boot)	Multimode	Black	CS000317
ST Field Master Connector (900 µm & 3.0 mm boot)	Multimode	Black	CS005147
ST Field Master Connector (900 µm boot)	Single-mode	Blue	CS000318
ST Field Master Connector (3.0 mm boot)	Single-mode	Blue	CS000319
ST Field Master Connector (900 µm & 3.0 mm boot)	Single-mode	Blue	CS005148
LC Field Master Connector (900 µm boot)	Multimode	White	CS000320
LC Field Master Connector (2.0 mm boot)	Multimode	White	CS000321
LC Field Master Connector (900 µm boot)	Single-mode	Blue	CS000322
LC Field Master Connector (2.0 mm boot)	Single-mode	Blue	CS000323
LC Duplex Field Master Connector (2.0 mm boot)	Multimode	White	CS000467
LC Duplex Field Master Connector (2.0 mm boot)	Single-mode	Blue	CS000466

* Packaged 100 pieces per bag.

Qualifications

GOVERNING BODY	STANDARD CODE
EIA/TIA	568B

Contact AFL for further details.



Field Master® Tool Kit

Field Master® Tool Kit comes with tools and consumables to professionally install Field Master® connectors. Crimp Tool sold separately.

Ordering Information

DESCRIPTION	AFL NO.
Field Master Tool Kit	FM000065
Kit includes:	
Strip Template	CS000868
Film, Lap, 5 inch disc, AL203, 3µm (10 per pack)	CS004881-10
Film, Lap, 5 inch disc, AL203, 1µm (10 per pack)	CS004882-10
Film, Lap, 5 inch disc, Diamond, 3µm (1 per pack)	CS004883-01
Rubber Polishing Pad (5")	C015407
Sharpie® Permanent Marker	C015830
Fiber Stripper	CS01205
Kevlar Scissors	C095257
Scribe Tool	C182635
Polishing Puck - SC, ST	CS000446
Polishing Puck - LC	CS000338
Cletox Stick Cleaner	C008812
Fiber Preparation Fluid (3 oz)	FPF1-00-0900
Applicator Tips for Adhesive	C006037
Water Bottle (1 oz)	C015849
Field Installable Adhesive with MSDS (1.75 oz)	C180691
Field Installable Primer with MSDS (1.75 oz)	C181310
Lint Free Cloth Wipes	FM000413
Installation Instructions (SC, ST, LC)	CS004389
Carrying Case	C199528

Features

- Quick and easy to use
- Compact
- Complete instructions included
- For use with SC, ST, and LC Field Master® Connectors



Crimp Tool for Field Master® Connectors

ITEM DESCRIPTION	AFL NO.
Crimp Tool with Die Set (SC, ST and LC) (Crimp diameters: 0.128" hex, 0.151" hex, 0.178" hex, 0.197" hex, 0.215" hex)	CS000337

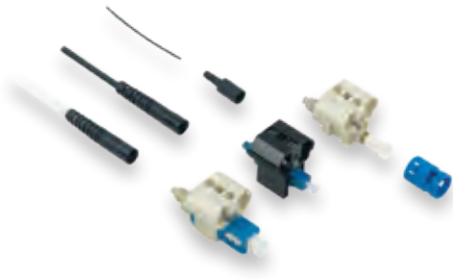

Features

- No epoxy, no Polish
- Low insertion loss
- Fiber can be reinserted up to three times
- 4.8 mm (SC only) cordage compatibility
- VFI accessory to confirm proper installation

Applications

- Premise/Enterprise Networks
- LAN/WAN Connections
- Patch Panels
- Equipment Termination
- FTTx Applications
- Field Repair/Replacement
- Equipment Test Leads

FASTConnect® Field-Installable Connectors

FASTConnect are factory pre-polished, field-installable connectors that completely eliminate the need for hand polishing in the field. Proven mechanical splice technology ensuring precision fiber alignment, a factory pre-cleaved fiber stub and a proprietary index-matching gel combine to offer an immediate low loss termination to either single-mode or multimode optical fibers. FASTConnect are compatible with 250 μm and 900 μm optical fibers, as well as 4.8 mm (SC only) cordage.

All primary fiber types are supported, and each connector is color coded per industry standard requirements to aid in identification during and after installation. A factory-installed wedge clip (included with each connector) is removed and discarded upon completion of the termination. Incorporated into this device is an innovative, translucent wedge enabling the use of a common VFI to provide a "pass/fail" signal once physical contact is achieved.

Specifications

PARAMETER	TYPE	VALUE
Insertion Loss:	Single-mode - UPC	Average: 0.2 dB, Maximum: 0.5 dB
	Single-mode - APC	Average: 0.3 dB, Maximum: 0.6 dB
	Multimode - PC	Average: 0.1 dB, Maximum: 0.5 dB
Return Loss at Room Temperature	Single-mode - UPC	Average: -50 dB, Maximum: -45 dB
	Single-mode - APC	Average: -55 dB, Maximum: -50 dB
	Multimode	Average: -25 dB, Maximum: -20 dB

Ordering Information

FIBER TYPE	HOUSING COLOR	CABLE SIZE	AFL NO.	
			PACKAGE OF 6	PACKAGE OF 100
FASTCONNECT SC				
Multimode 62.5/125 μm, OM1	Beige	900 μm	FAST-SC-MM62.5-6	FAST-SC-MM62.5-100
Multimode 50/125 μm, OM2	Black		FAST-SC-MM50-6	FAST-SC-MM50-100
Multimode 50/125 μm, OM3/OM4 compatible	Aqua		FAST-SC-MM50L-6	FAST-SC-MM50L-100
Single-mode, UPC	Blue		FAST-SC-SM-6	FAST-SC-SM-100
Single-mode, APC	Green		FAST-SC-SMAU-6	FAST-SC-SMAU-100
Single-mode, APC	Green	4.8 mm	FAST-SC48-SMAU-6	FAST-SC48-SMAU-100
FASTCONNECT ST				
Multimode 62.5/125 μm, OM1	Beige	900 μm	FAST-ST-MM62.5-6	FAST-ST-MM62.5-100
Multimode 50/125 μm, OM2	Black		FAST-ST-MM50-6	FAST-ST-MM50-100
Multimode 50/125 μm, OM3/OM4 compatible	Aqua		FAST-ST-MM50L-6	FAST-ST-MM50L-100
Single-mode, UPC	Blue		FAST-ST-SM-6	FAST-ST-SM-100
FASTCONNECT LC				
Multimode 62.5/125 μm, OM1	Beige	900 μm	FAST-LC-MM62.5-6	FAST-LC-MM62.5-100
Multimode 50/125 μm, OM2	Black		FAST-LC-MM50-6	FAST-LC-MM50-100
Multimode 50/125 μm, OM3/OM4 compatible	Aqua		FAST-LC-MM50L-6	FAST-LC-MM50L-100
Single-mode, UPC	Blue		FAST-LC-SM-6	FAST-LC-SM-100
Single-mode, APC	Green		FAST-LC-SMAU-6	FAST-LC-SMAU-100

continued



FASTConnect® Field-Installable Connectors

Accessories

DESCRIPTION			AFL NO.	AFL NO.
BOOT KITS FOR 2 MM AND 3 MM CORDAGE	COLOR	CABLE SIZE	PACK OF 6	PACK OF 100
2 mm Boot Kit, SC/LC/ST	Black	2 mm	FAST-BOOT-2MM-6	FAST-BOOT-2MM-100
3 mm Boot Kit, SC/LC/ST	Black	3 mm	FAST-BOOT-3MM-6	FAST-BOOT-3MM-100
DUPLEX CLIPS				
LC Duplex Clip (LC only)	Transparent		CS010437-06	CS010437-100
TOOL KITS				AFL NO.
FASTConnect High Precision Tool Kit with CT50 Cleaver				CS001201
FASTConnect High Precision Tool Kit with CT08 Cleaver				CS010975
VISUAL FAULT IDENTIFIERS				AFL NO.
VF14 visual fault identifier with 2.5 mm and 1.25 mm adapters				VF14-01-0900PR
2.5 mm Universal for VFI port				2900-50-0013MR
1.25 mm Universal for VFI port				2900-50-0012MR

Qualifications

GOVERNING BODY	STANDARD CODE
EIA/TIA	568-C.3 604 (FOCIS)

Temperature Specifications

TEMPERATURE RANGE	
Operating Temperature	-40°C to +75°C

Patents

COUNTRY	PATENT NUMBER(S)
U.S.	5,963,699 5,984,532 6,179,482 7,003,208 7,258,496

Contact AFL for further details.



FUSEConnect Connectors (SC, FC, LC, ST)

FUSEConnect® Fusion-Spliced, Field-Installable Connectors

AFL's FUSEConnect fusion-spliced, field installable connectors are uniquely designed and feature only four to five components. The factory pre-polished ferrule eliminates the need for polishing, adhesives, and crimping in the field, which minimizes the potential for operator error and expensive connector scrap.

FUSEConnect utilizes a fusion splicer to terminate the connector in the field, addressing return loss concerns present in analog optical networks. This advanced process yields true APC performance for SC/APC and LC/APC configurations. FUSEConnect is compatible with Fujikura fusion splicers and most other fiber holder-based fusion splicing platforms.

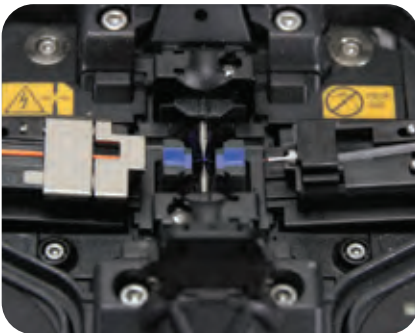

FUSEConnect in Fusion Splicer

Features

- Field installable
- No adhesives, crimping or polishing
- True APC performance
- Compatible with most fusion splicers

Applications

- Connectorization in:
 - RF-overlay FTTP networks
 - Cable TV backbone networks
 - Outside plant
 - FTTD
 - MDU FTTP Cabling
- Central office connector replacement
- Data center installation

Specifications

PARAMETER	VALUE
Connector Type	SC, LC, FC, ST
Cable Type	900 μm, 2 mm, 3 mm, 4.8 mm (SC only)
Polish	APC, UPC, PC
Insertion Loss	SM: 0.15 dB (average), 0.25 dB (maximum) / MM: 0.10 dB (average), 0.25 dB (maximum)
Return Loss	SM: ≤ -65 dB (APC), ≤ -55 dB (UPC) / MM: ≤ -35 dB (PC)

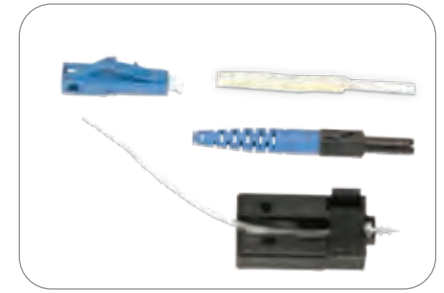
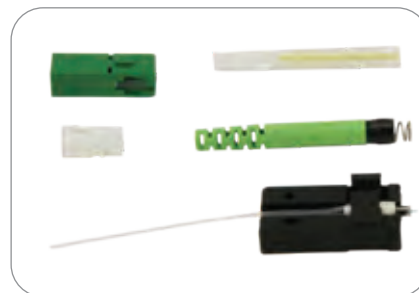
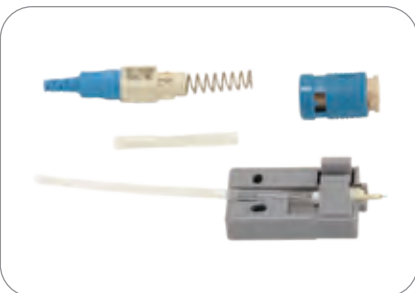

FUSEConnect Kits—ST (blue), SC (green), LC (blue)

continued
→

FUSEConnect® Fusion-Spliced, Field-Installable Connectors

Ordering Information

CONNECTOR TYPE	BOOT TYPE	AFL NO.*				
		UPC SM (Blue)	APC SM (Green)	PC 62.5 μm MM (Beige)	PC 50 μm MM (Black)	PC 50 μm LOMMF (AQUA) **
SC	900 μm	FUSE-SC9SMU-6	FUSE-SC9SMA-6	FUSE-SC9M62-6	FUSE-SC9M50-6	FUSE-SC9M50L-6
	3 mm	FUSE-SC3SMU-6	FUSE-SC3SMA-6	FUSE-SC3M62-6	FUSE-SC3M50-6	FUSE-SC3M50L-6
	4.8 mm	FUSE-SC48SMU-6	FUSE-SC48SMA-6	—	—	—
LC	900 μm	FUSE-LC9SMU-6	FUSE-LC9SMA-6	FUSE-LC9M62-6	FUSE-LC9M50-6	FUSE-LC9M50L-6
	2 mm	FUSE-LC2SMU-6	FUSE-LC2SMA-6	FUSE-LC2M62-6	FUSE-LC2M50-6	FUSE-LC2M50L-6
FC	900 μm	FUSE-FC9SMU-6	—	FUSE-FC9M62-6	FUSE-FC9M50-6	FUSE-FC9M50L-6
	2 mm	FUSE-FC2SMU-6	—	FUSE-FC2M62-6	FUSE-FC2M50-6	FUSE-FC2M50L-6
	3 mm	FUSE-FC3SMU-6	—	FUSE-FC3M62-6	FUSE-FC3M50-6	FUSE-FC3M50L-6
ST	900 μm	FUSE-ST9SMU-6	—	FUSE-ST9M62-6	FUSE-ST9M50-6	FUSE-ST9M50L-6
	2 mm	FUSE-ST2SMU-6	—	FUSE-ST2M62-6	FUSE-ST2M50-6	FUSE-ST2M50L-6
	3 mm	FUSE-ST3SMU-6	—	FUSE-ST3M62-6	FUSE-ST3M50-6	FUSE-ST3M50L-6

* AFL NO. is for one pack of 6 pieces

** Laser Optimized MM Fiber (LOMMF) compatible with OM3 and OM4 fibers

Temperature Specifications

TEMPERATURE RANGE	
Operating Temperature	-40°C to +75°C



FUSEConnect Tool Kit Contents

FUSEConnect® Tool Kit and Accessories

The FUSEConnect tool kit provides all the necessary installation tools required for fiber preparation of 900 μm fiber, 2 mm or 3 mm cordage for AFL’s FUSEConnect Fusion Spliced Field Installable Connectors except for a fusion splicer and precision cleaver. Included in the kit are standard fiber preparation tools and cleaning supplies as well as a FUSEConnect accessory kit and cord splitter tool, which can be bought separately from the tool kit. The cord splitter tool is uniquely designed to open the cordage of 2 mm and 3 mm cable allowing the termination of the ST and FC type connectors on simplex cordage.



FUSEConnect Accessory Kit

Features

- Industry standard fiber preparation tools
- Compact design, flexible yet rugged case

Applications

- Premise environments
- LAN Fiber to the Desk environments
- Patch panel/wiring closets
- FTTx applications
- Quick repair/replacement areas



Cord Splitter Tool

Ordering Information

DESCRIPTION	AFL NO.
FUSECONNECT TOOL KIT (INCLUDES ITEMS BELOW)	FUSE-TL-KT
Tool Case	CS001202
Fiber Stripper	CS001205
Kevlar Scissors	C095257
Lint-Free Wipes	FM000413
Fiber Preparation Fluid	FPF1-00-0900
Permanent Marker	C015830
Cord Splitter Tool	FUSE-ST-TL
FUSEConnect Accessory Kit	FUSE-AC-KT

FUSEConnect Accessory Kit (includes items below)	FUSE-AC-KT
Utility Storage Box	CS012351
Clamp for holding 3 mm Simplex Cordage	S014704
Clamp for holding 2 mm Simplex Cordage	S014705
250 μm / 900 μm Fiber Clamp	CS004442
3 mm FUSEConnect Fiber Holder	S014695
2 mm FUSEConnect Fiber Holder	S014696
900 μm FUSEConnect Fiber Holder	S014697
CLAMP-S70D Sheath Clamp	S015862
CLAMP-S31B Sheath Clamp	S017101

Cord Splitter Tool	FUSE-ST-TL
---------------------------	-------------------

Legacy Splicer Accessories (Required for Fanout Splicing)	
CLAMP-S21B Sheath Clamp	S016853
CLAMP-S60D Sheath Clamp	S014750



Optical Terminators

Optical terminators are used to terminate unused connector ports in fiber optic systems so that unwanted reflections are not introduced back into the system. All AFL optical terminators feature zirconia ferrules for long life and durability.

Specifications

PARAMETER	VALUE
Reflectance	<-55 dB (ultra polish)
Reflectance	<-60 dB (angle polish)
Operating Temperature	-40°C to +85°C
Operating Wavelength	1260 nm to 1580 nm

Ordering Information

DESCRIPTION	AFL NO.
SC/UP Terminator	C067393
SC/AP Terminator	C148828
FC/UP Terminator	C067407
FC/AP Terminator	C082562
ST/UP Terminator	C167083
LC/UP Terminator	CS000637
LC/AP Terminator	CS000638



Fanout Kits

Fanout kits route 250 μm fibers into 900 μm buffer tubes ready for termination. These kits require no special tools and accommodate input cables from 2.0-3.8 mm in diameter. Fanout kits feature a clear, removable cover which is VFL-compatible and does not require epoxy. Color-coded 900 μm buffer tubes allow for easy identification of individual fiber channels.



Features

- Accepts 2.0-3.8 mm input cable
- Epoxy-free installation
- Clear, removable cover works with Visual Fault Locators (VFL)
- Protects sensitive 250 μm fibers
- Compatible with FUSEConnect® and FASTConnect® field-installable connectors

Applications

- Routing 250 μm fibers into 900 μm buffer tubes for termination

Specifications

PARAMETER	VALUE
Fiber Count	12
Environment	Indoor
Input Cable Size	2.0 - 3.8 mm
Length	1 m

Temperature Specifications

TEMPERATURE RANGE	
Operation	-0°C to 70°C

Ordering Information

AFL NO.	DESCRIPTION
FAN1-9-012-A-01	Fanout kit, 1 position base, 900 μm , 12 tubes, A, 1M



Duplex Cable Assemblies

Zipcord cables are used to meet the requirements for two-fiber cable assemblies, utilizing SC, FC, ST and LC connectors.

Features

- Flexible, 2-fiber design
- Riser, Plenum and LSZH* rated cables available (*contact AFL)

Applications

- Private networks
- Data centers
- High-density applications
- Interconnect and cross-connect
- Premise installations

Cable Components

Zipcord

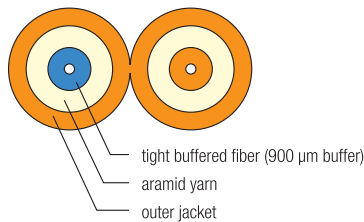

Qualifications

GOVERNING BODY	STANDARD CODE	COMPONENT
Telcordia	GR-409 GR-326	Cable Connectors
RoHS	Compliant	Cable
ITU	G.652.D, G.657.A1	Single-mode optical fiber only

Contact AFL for further details.

Ordering Information

UST	UST	RZ	002	Q	0010
Connector End A	Connector End B	Cable Type	Fiber Count	Fiber Type	Cable Length (meters)
Single-mode AFC = Angle FC UFC = Ultra FC }* UST = Ultra ST ADL = Angled LC Duplex ASF = Angled SC Duplex USF = Ultra SC Duplex UDL = Ultra LC Duplex Multimode PFC = FC MM }* PST = ST MM }* PSF = SC Duplex MM PDL = LC Duplex MM	Single-mode AFC = Angle FC UFC = Ultra FC }* UST = Ultra ST ADL = Angled LC Duplex ASF = Angled SC Duplex USF = Ultra SC Duplex UDL = Ultra LC Duplex XXX = No connector Multimode PFC = FC MM }* PST = ST MM }* PSF = SC Duplex MM PDL = LC Duplex MM XXX = No connector	Zipcord RZ = 3.0 mm Riser PZ = 3.0 mm Plenum R20Z = 2.0 mm Riser P20Z = 2.0 mm Plenum R16Z = 1.6 mm Riser P16Z = 1.6 mm Plenum	002 = 2	Q = Single-mode** 2 = Multimode 62.5/125 OM1 L = Multimode 50/125 OM3 C = Multimode 50/125 OM4	XXXX (specify length) 0010 = 10 meters
NOTES: 1. Refer to Connector Specifications page. * Single connector options, quantity two per end. Duplex connectors are assembled with removable clip. ** All Single-mode cable assemblies use the ITU G.652.D/G.657.A1 standard. *** LC Connectors available on 2.0 mm Zipcord cable.					

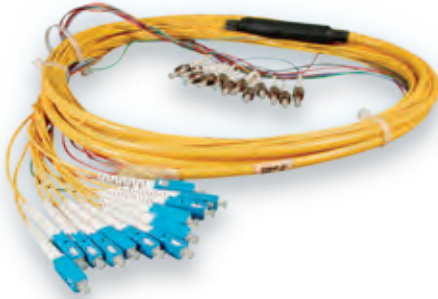

Multi-Fiber Cable Assemblies

Multi-fiber cable assemblies provide safe and cost effective installation for many applications. These assemblies help eliminate labor-intensive field termination, yet guarantee reliable performance. These assemblies feature a unified construction for easy fiber identification and rapid installation.

Features

- 4-144 fibers with aramid yarn reinforcement for rugged protection
- Available with 900 μm tight buffered fibers or sub-unitized design with twelve 250 μm fibers per tube
- Highly flexible for ease of routing
- Riser, Plenum and LSZH rated cables available
- Pre-installed pulling eye kits available on certain products

Applications

- Headend termination to a fiber "backbone"
- Termination of fiber rack systems
- Multi-floor deployment where select fibers are used at each floor
- Intra-building "backbones"
- Data center systems

Specifications

PARAMETER	SINGLE-MODE ASSEMBLIES				MULTIMODE ASSEMBLIES	
	LC		SC		LC	SC
	ULTRA	ANGLED	ULTRA	ANGLED		
Insertion Loss (Typical dB)***	0.15	0.15	0.15	0.15	0.15	0.15
Insertion Loss (Maximum dB)	0.3	0.3	0.3	0.3	0.5	0.5
Return Loss (Typical dB)***	-60	-70	-60	-70	-35	-35
Return Loss (Minimum dB)	-55	-65	-55	-65	-30	-30

*** Typical values based on equal quality connectors.

continued
→

Multi-Fiber Cable Assemblies

Ordering Information

ASC	ASC	RC	012	Q	0010	NN
Connector End A	Connector End B	Cable Type	Fiber Count	Fiber Type	Cable Length (meters)	Leg Diameter
Single-mode ASC = Angle SC AFC = Angle FC USC = Ultra SC UFC = Ultra FC UST = Ultra ST ULC = Ultra LC UDL = Ultra LC Duplex Multimode PSC = SC MM PFC = FC MM PLC = LC MM PST = ST MM PDL = LC Duplex MM* PSF = SC Duplex MM*	Single-mode ASC = Angle SC AFC = Angle FC USC = Ultra SC UFC = Ultra FC UST = Ultra ST ULC = Ultra LC XXX = No connector Multimode PSC = SC MM PFC = FC MM PLC = LC MM PST = ST MM XXX = No connector	RC = Riser (CPC) PC = Plenum (CPC) PL = Plenum MicroCore®	004 = 4 006 = 6 012 = 12 024 = 24 036 = 36 048 = 48 072 = 72 096 = 96 144 = 144	Q = Single-mode ITU G.652D/ G.657.A1 2 = Multimode 62.5/125 μm OM1 L = Multimode 50/125 μm OM3 C = Multimode 50/125 μm OM4	XXXX (specify length) 0010 = 10 meters Leg Diameter N = 900 μm End A / XXX End B NN = 900 μm End A and B F = Furcated End A / XXX End B FF = Furcated Ends A and B FN = Furcated Ends A / 900 μm End B NF = 900 μm End A / Furcated Ends B	

NOTES:

1. Refer to Connector Specifications page.
2. Duplex SC and LC available

Qualifications

GOVERNING BODY	STANDARD CODE	COMPONENT
EIA/TIA	568-A	Cable
Telcordia	GR-409-CORE GR-326	Cable Connectors
RoHS	Compliant	Cable

Temperature Specifications

Temperature Range	-40°C to +85°C
-------------------	----------------

Contact AFL for further details.



Sealed Fiber Optic Splice Closures

AFL's sealed fiber optic splice closures are designed to simplify splice management and maintenance. Intuitive engineering design reduces the installation time and complexity associated with fiber splicing in the field. No heat, adhesives, drills or powered equipment for installation or re-entry are required, just simply use a common can wrench to access and install cable. These closures are durable, easy-to-install and will increase productivity, reduce labor expenses, and last the life of your plant.

Features

- LG Series closures support stranded loose tube, Uniflex or ribbon fiber cables in either armored or dielectric configurations
- New Apex® Sealed Closures also support "rollable ribbon" fiber types including AFL's SpiderWeb Ribbon® (SWR®)
- Fully sealed to protect fiber and splices ensuring longevity
- Fully kitted with all parts to install cables

Specifications

DESCRIPTION	MODEL							
	LG-55-U-0	APEX X-2	APEX X-2S	LG-150-U-0	LG-250-U-0	LG-350-U-0	LG-350-AC	LG-350XL-U-0
Splice Capacity (Max.) – Single, Mass, Mechanical	24, n/a, 24	432, 3456, 864	216, 1728, 432	48, 192, 48	144, 432, 48	480, 1152, 108 ²	144, 432, 48	864, 2592, 288
Number of Splice Trays (Max.) – Single, Mass, Mechanical	1, n/a, 1	6		4, 3, 4		12, 8, 8	4, 3, 4	9, 9, 9
Cable Entrance Configuration	In-line / Butt	Butt						
Cable Ports	2	6		5			2 (Express Grommets) 3 (4-Drop Grommets)	5 (7 using dual port grommet Express sides)
Cable Sizes (Max. O.D.) in. (mm)	2 @ 0.70 (17.78) (splice)	Single Port: 0.40- 1.10 (10.0 - 28.0) Multi-Drop Kit: 0.20 - 0.39 (5.0 - 9.9) or flat drop		5 @ 0.62 (15.748)		3 @ 0.80 (20.32) 2 @ 1.00 (25.4)	2 @ 1.0 (25.4) 12 @ 0.312 (7.9248) Flat or 0.250" (6.35) Round	3 @ 1.08 (27.432) 2 @ 1.18 (29.972)
Testing - Cable Retention (100 lbs) - Water Resistance (waterhead) - Impact Resistance (0-40 °C) - Chemical Resistance - Cable Flexing	Passed 20 ft. Passed Passed Passed	—	—	Passed 20 ft. Passed Passed Passed				
Dimensions – (L x D) in. (cm)	14.00 x 4.00 (35.6 x 10.16)	25.0 x 12.0 (64 x 30)	20.0 x 12.0 (51 x 30)	18.25 x 8.75 (463.6 x 222.3)	19.0 x 8.75 (463.6 x 222.3)	28.00 x 10.00 (71.12 x 25.4)	20 x 10 (51 x 25.4)	31.00 x 12.00 (78.74 x 30.48)
Weight – lbs. (kg)	3.0 (1.36)	25 (11.3)	22 (10)	10.5 (4.76)	10.5 (4.76)	16 (7.26)	12.0 (5.44)	25 (11.34)

NOTES: 1. For the LG-250-U-0; 36 mechanical splices only using the LL-2448 splice tray.
2. For the LG-350-U-0; 108 mechanical splices only using the LL-2448 splice tray.

Qualifications

GOVERNING BODY	STANDARD CODE
Telcordia	GR-771
Rural Utilities Service (RUS)	Listed



Apex® X-2 Sealed Splice Closure

The Apex X-2 is a sealed splice closure designed for protecting optical fiber splices in both above- or below-grade applications in a butt configuration. The Apex X-2 is capable of up to 432 single fusion, 864 mass fusion with standard ribbon, or 3456 (200 μm, 1728 max for 250 μm) mass fusion with “rollable ribbon” fiber types such as AFL’s SpiderWeb Ribbon® (SWR®). Cables are sealed by a unique wedge system spaced evenly around the circumference of the closure’s base. Each cable seal is opened by a press-to-release lever and sealing is completed by actuating a single screw for each cable. Each cable is sealed individually, ensuring original craftsmanship when cables may be added at a later date. Up to 6 splice trays are attached and hinge off a central organizer. A plastic slack storage basket resides underneath the trays with ample tie down points for managing tube and fiber slack.

Features

- Individual cable sealing ports with tool-less release mechanism and gel sealing
- Hinging, lockable splice trays
- Plastic slack storage basket with optional segmented basket to separate ribbon and loose tube slack storage
- Six cable ports with up to six ground lugs
- Capable of up to 16 drop cables with an expressed distribution cable using multi-drop entry kits
- Splice trays with universal splice modules capable of holding single fusion, mass fusion and mechanical splices as well as other devices such as passive optical splitters
- Dome-to-base O-ring seal retained into dome to prevent loss or damage, but is still replaceable if necessary

Specifications

PARAMETER	VALUE
Dimensions – L x D, in (cm)	25.0 x 12.0 (64 x 30)
Weight, No Trays – lb (kg)	25 (11.3)
Splice Capacity – Single, Mass (SWR), Mass (Standard)	432, 3456, 864
Splice Tray Capacity	6
Cable Diameter, Single Port, in (mm)	0.40" – 1.10" (10.0 – 28.0)
Cable Diameter, Multi-Drop Kit, in (mm)	0.20" – 0.39" (5.0 – 9.9) or flat drop
Application	Direct Bury, Handhole, Aerial, Pole/Wall

Apex® X-2 Sealed Splice Closure



Gel Sealing

Individual wedges located evenly around the circumference of the base are removed with the press of a button. When cables are in place and ready to be sealed, the gel is compressed by a single screw, decreasing installation time. Individual port seals ensure cables never become unsealed when adding new cables at a later date.

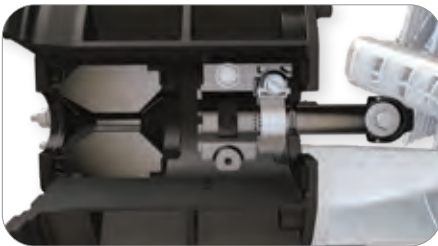

Cable Entry Ports and Strain Relief

The cable entry ports surrounding the circumference of the base accept single cables from 0.4" to 1.1" in diameter. These ports can be expanded through the use of optional drop cable entry kits, allowing up to 4 flat drops or cables from 0.2" to 0.39" to use a single port. Additionally, each port has the capability to be paired with its own grounding lug if necessary. Closures can be configured with enough strain relief kits for 2 to 6 cables from the factory. For closures with less than 6, additional cables can be added through the use of additional cable strain relief kits sold separately.



Slack Storage

A molded slack storage basket allows for use of the entire cross section of the closure to maximize storage. An optional segmented hinging basket is available to separate ribbon and loose tube slack, and can be locked in the upward position for access to expressed fibers below.

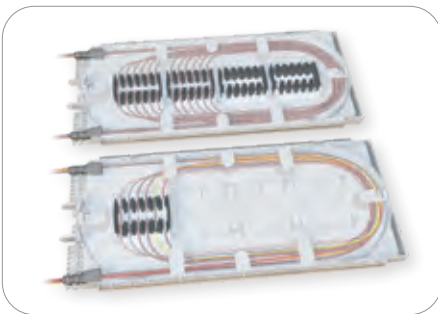

Splice Trays with Modular Splice Holders

Splice trays are organized in a hinging array that automatically lock when tilted to the upward position for easy access to the splice trays and slack storage below. The universal splice module holds up to 18 single fusion, 6 mass fusion or 12 mass fusion double-stacked when using SWR, or 6 mechanical splices as well as devices such as PLC splitters. This eliminates the need for specifying and stocking multiple splice trays for multiple applications.

Ordering Information

AX	2	B	L	0	2	6	B
APEX CLOSURES	CLOSURE SIZE	BASKET TYPE	TRAY TYPE	NUMBER OF TRAYS	CABLE STRAIN RELIEF HARDWARE KITS	NUMBER OF GROUND LUGS	INNER BASKET
	2 = X-2 Size	B = X-2 Sized Basket	X = No preinstalled tray L = X-2 Tray Loaded with splice modules	0 1 6	2 4 6	0 2 6	X = No Inner Basket B = Include Inner Basket

Apex® X-2 Sealed Splice Closure

Splice Trays and Splice Modules

Apex X-2 closures utilize X-2 size splice trays. Trays can be ordered fully loaded or half loaded with splice modules. For “rollable” type ribbon such as AFL’s SpiderWeb Ribbon, trays can be fully loaded for 48 double-stacked mass splices, or 576 fibers per tray. For standard ribbon, AFL recommends half loaded for 12 mass splices single-stacked, or 144 fibers.

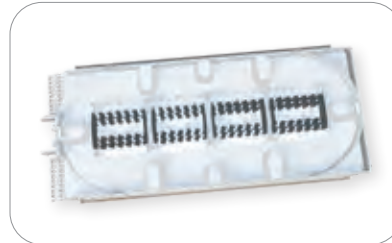

Ordering Information

DESCRIPTION	TRAY CAPACITY		AFL NO.
	SINGLE	MASS	
X-2 Tray Loaded with Two Splice Modules	36	144	AX-TRAY-2-2
X-2 Tray Fully Loaded with Four Splice Modules (576 fibers per tray only recommended for rollable ribbon, e.g. AFL SWR)	72	576	AX-TRAY-2-4
Additional splice module (18 single fusion triple stacked, 12 mass fusion double stacked, 6 mechanical) – Pack of 20	-	-	AX-TRAY-MOD-20
X-2 Tray Empty	-	-	AX-TRAY-2-E

*576 fibers per tray with mass fusion double-stacking (3456 total closure capacity) only recommended for 200 μm type rollable ribbon. For 250 μm, cut capacity in half with single-stacking

Dimensions

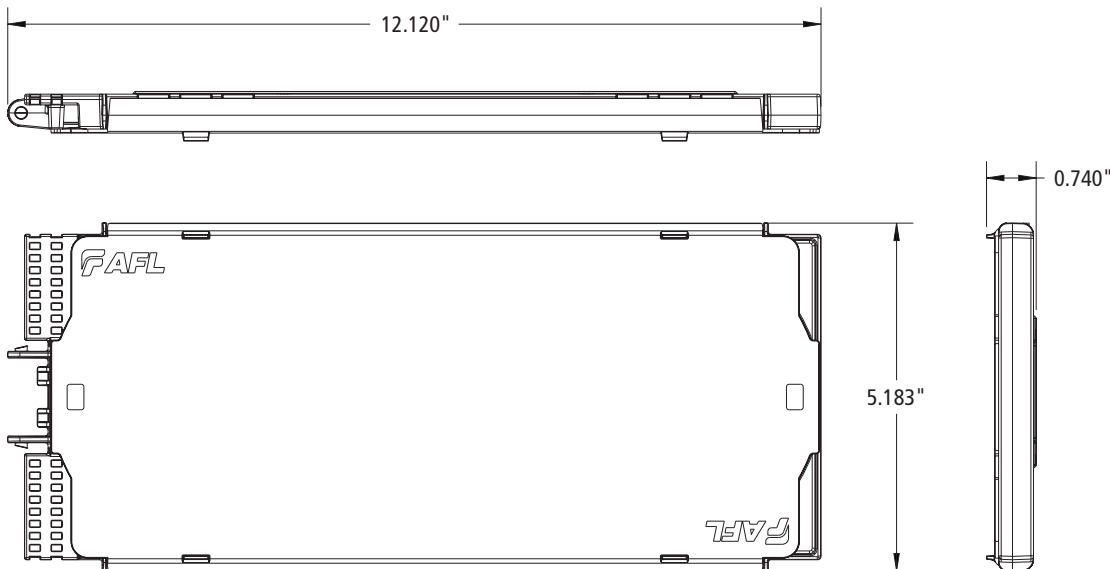

Apex® X-2 Sealed Splice Closure

Slack Storage Basket and Accessories

The Apex X-2 slack storage basket is molded with a rounded cross section to efficiently maximize space inside of the cylindrical dome closure. The basket has optional accessories such as the segmented basket, which provides a “basket within a basket” to manage ribbon and loose tube slack separately.

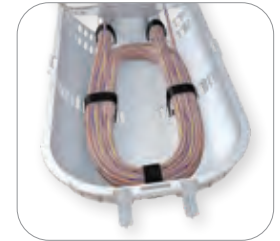
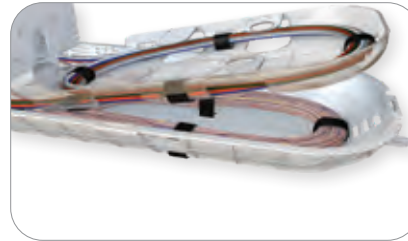

Ordering Information

DESCRIPTION	AFL NO.
Clear segmented basket for X-2. Can be used in combination with the basket cover	AX-KIT-SBASKET-2
Replacement slack storage basket tabs – Pack of 25	AX-KIT-BTAB-25

Slack Length

CABLE/COMPONENT	TYPE OF OPENING	STRIP LENGTH (INCHES)
WTC/SWR or Non-Matrix Ribbon	Mid Sheath	**111-134
	End Cut	**54-90
Flat Matrix Ribbon Cable	Mid Sheath	*108-110
	End Cut	*54-57
***Loose Tube Cable	Mid Sheath	**111-134
	End Cut	**54-90
STORAGE		
Each additional basket storage loop		23-27
Each additional splice tray service loop		26-27
Sheath to basket for tube retention		8-11
DEFINITION		
Midsheath	Slack loop in basket, service loop in tray, center cut	
End cut	Slack loop in basket, service loop in tray, to far splice	
* Ribbon minimum is slack loop in basket, no slack waterfall splicing in tray		
** Minimum no service loop in splice tray - Maximum allowing for service loop in splice tray		
*** LT storage max tubes	Additional tubes will decrease cable lengths	18 (432/24 per tube)

Apex® X-2 Sealed Splice Closure

Installation Accessories and Kits

The AFL Apex X-2 closure line has a variety of installation accessories kits to fit many applications. Additional accessories not listed here may be available by contacting AFL.

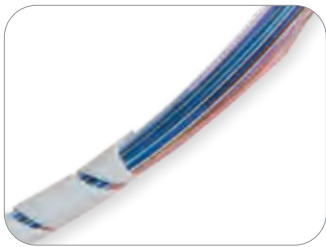

Silicone Spiral Wrap

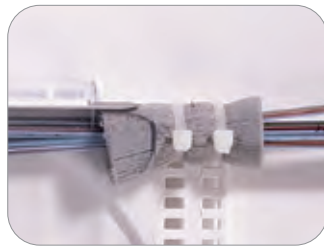

Foam Retention



Apex® Aerial Hanger Bracket



Apex® Pole/Wall Mount

Ordering Information

DESCRIPTION	AFL NO.
Aerial strand mount hanger kit	AX-KIT-AERIAL-1
Pole/wall mount kit	AX-BR30
1/4" Colored Mesh Transition Tubing, 250' Spool	AX-KIT-TUBE-014-XX*
Single Cable Strain Relief/Attachment Kit	AX-KIT-CBLSTRN
Multi-Drop Cable Entry Kit (fits up to 4 cables 0.20" to 0.39" in diameter or flat drop cable)	AX-KIT-DROP-4
X-2 and X-2S Dome to Base O-Ring Replacement Kit	AX-KIT-ORING-2
X-2 and X-2S O-Ring Grease, Pack of 10	AX-KIT-GREASE-10
X-2 and X-2S Dome to Base Locking Ring Clamp Replacement Kit	AX-KIT-CLAMP-2
X-2 and X-2S Wedge Replacement Kit	AX-KIT-WEDGE-2
X-2 and X-2S Installation Stand	FC104649
Apex X-2 and X-2S Inner Base Gel Replacement Kit	AX-KIT-GEL-2
Apex X-2 Dome Replacement Kit	AX-KIT-DOME-2
WTC-SWR Bundle Splice Tray Retention Kit - Includes 25 foam grommets for retaining SWR bundles to splice trays	HW000406
Silicone Spiral Wrap, 5.5 Foot Length	FC001657
Velcro, 75 Foot Length Roll – For securing SWR bundles in the slack basket	FC001759
Apex Cable Bonding Kit (Bonds armored cable sheath to ground) – Alligator clip on one end, eyelet on other end – Pack of 10	AX-KIT-GROUND-10

*Replace "XX" with any of the following for colors per the TIA-598 color code - BL, OR, GR, BR, SL, WH, RD, BK, YL, VI, RS or AQ

Apex® X-2 Sealed Splice Closure

Splitter Splice Trays

Passive optical splitters, or PLCs (Planar Lightwave Circuits), can be provided preinstalled into the Apex X-2 splice tray. PLCs can either be installed and splice within the same tray, or provided with a separate dedicated tray for splicing, with fibers routed between trays using protective tubing. A third option provides one additional tray to separate input and output fiber splicing.

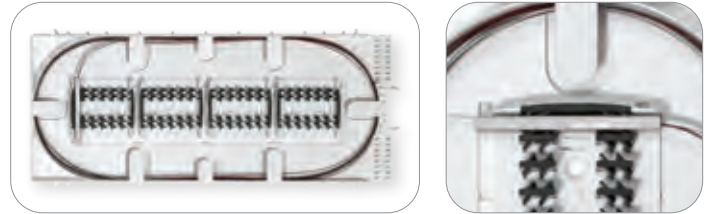

Ordering Information

DESCRIPTION	SPLIT RATIO	AFL NO.
X-2 Tray with Four Splice Modules, (1) 1x2 PLC Splitter	1x2	AX-TRAY-2-12-1
X-2 Tray with Four Splice Modules, (1) 1x4 PLC Splitter	1x4	AX-TRAY-2-14-1
X-2 Tray with Four Splice Modules, (1) 1x8 PLC Splitter	1x8	AX-TRAY-2-18-1
X-2 Tray with Four Splice Modules, (1) 1x16 PLC Splitter	1x16	AX-TRAY-2-116-1
X-2 Tray with Four Splice Modules, (1) 1x32 PLC Splitter	1x32	AX-TRAY-2-132-1
X-2 Tray with (1) 1x2 PLC Splitter and Separate Splicing Tray with Four Splice Modules	1x2	AX-TRAY-2-12-2
X-2 Tray with (1) 1x4 PLC Splitter and Separate Splicing Tray with Four Splice Modules	1x4	AX-TRAY-2-14-2
X-2 Tray with (1) 1x8 PLC Splitter and Separate Splicing Tray with Four Splice Modules	1x8	AX-TRAY-2-18-2
X-2 Tray with (1) 1x16 PLC Splitter and Separate Splicing Tray with Four Splice Modules	1x16	AX-TRAY-2-116-2
X-2 Tray with (1) 1x32 PLC Splitter and Separate Splicing Tray with Four Splice Modules	1x32	AX-TRAY-2-132-2
X-2 Tray with (1) 1x2 PLC Splitter and 2 Separate Splicing Trays with Four Splice Modules each	1x2	AX-TRAY-2-12-3
X-2 Tray with (1) 1x4 PLC Splitter and 2 Separate Splicing Trays with Four Splice Modules each	1x4	AX-TRAY-2-14-3
X-2 Tray with (1) 1x8 PLC Splitter and 2 Separate Splicing Trays with Four Splice Modules each	1x8	AX-TRAY-2-18-3
X-2 Tray with (1) 1x16 PLC Splitter and 2 Separate Splicing Trays with Four Splice Modules each	1x16	AX-TRAY-2-116-3
X-2 Tray with (1) 1x32 PLC Splitter and 2 Separate Splicing Trays with Four Splice Modules each	1x32	AX-TRAY-2-132-3

Relevant Standards

GOVERNING BODY	STANDARD CODE
Telcordia	GR-771



Apex® X-2S Sealed Splice Closure

The Apex X-2S is a sealed splice closure designed for protecting optical fiber splices in both above- or below-grade applications in a butt configuration. The Apex X-2S is capable of up to 216 single fusion, 432 mass fusion with standard ribbon, or 1728 (200 μm, 864 max for 250 μm) mass fusion with “rollable ribbon” fiber types such as AFL’s SpiderWeb Ribbon® (SWR®). Cables are sealed by a unique wedge system spaced evenly around the circumference of the closure’s base. Each cable seal is opened by a press-to-release lever and sealing is completed by actuating a single screw for each cable. Each cable is sealed individually, ensuring original craftsmanship when cables may be added at a later date. Up to 6 splice trays are attached and hinge off a central organizer. A plastic slack storage basket resides underneath the trays with ample tie down points for managing tube and fiber slack.

Features

- Individual cable sealing ports with tool-less release mechanism and gel sealing
- Hinging, lockable splice trays
- Plastic slack storage basket with optional segmented basket to separate ribbon and loose tube slack storage
- Six cable ports with up to six ground lugs
- Capable of up to 16 drop cables with an expressed distribution cable using multi-drop entry kits
- Splice trays with universal splice modules capable of holding single fusion, mass fusion and mechanical splices as well as other devices such as passive optical splitters
- Dome-to-base O-ring seal retained into dome to prevent loss or damage, but is still replaceable if necessary

Specifications

PARAMETER	VALUE
Dimensions – L x D, in (cm)	20.0 x 12.0 (51 x 30)
Weight, No Trays – lb (kg)	22 (10)
Splice Capacity – Single, Mass (SWR), Mass (Standard)	216, 1728, 432
Splice Tray Capacity	6
Cable Diameter, Single Port, in (mm)	0.40" – 1.10" (10.0 - 28.0)
Cable Diameter, Multi-Drop Kit, in (mm)	0.20" – 0.39" (5.0 - 9.9) or flat drop
Application	Direct Bury, Handhole, Aerial, Pole/Wall

Apex® X-2S Sealed Splice Closure



Gel Sealing

Individual wedges located evenly around the circumference of the base are removed with the press of a button. When cables are in place and ready to be sealed, the gel is compressed by a single screw, decreasing installation time. Individual port seals ensure cables never become unsealed when adding new cables at a later date.

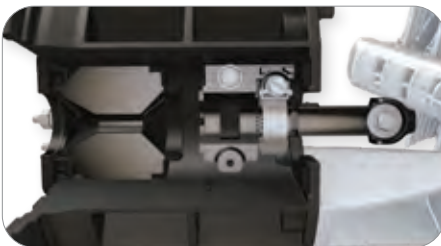

Cable Entry Ports and Strain Relief

The cable entry ports surrounding the circumference of the base accept single cables from 0.4" to 1.1" in diameter. These ports can be expanded through the use of optional drop cable entry kits, allowing up to 4 flat drops or cables from 0.2" to 0.39" to use a single port. Additionally, each port has the capability to be paired with its own grounding lug if necessary. Closures can be configured with enough strain relief kits for 2 to 6 cables from the factory. For closures with less than 6, additional cables can be added through the use of additional cable strain relief kits sold separately.



Slack Storage

A molded slack storage basket allows for use of the entire cross section of the closure to maximize storage.

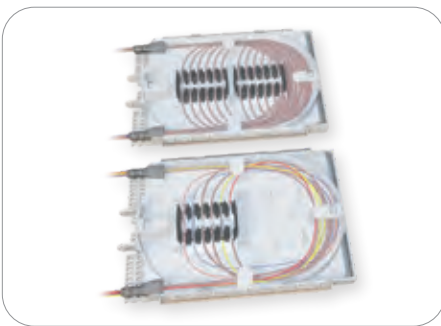

Splice Trays with Modular Splice Holders

Splice trays are organized in a hinging array that automatically lock when tilted to the upward position for easy access to the splice trays and slack storage below. The universal splice module holds up to 18 single fusion, 6 mass fusion or 12 mass fusion double-stacked when using SWR, or 6 mechanical splices as well as devices such as PLC splitters. This eliminates the need for specifying and stocking multiple splice trays for multiple applications.

Ordering Information

AX	—	2S	—	B	—	L	—	0	—	2	—	6	—	X
APEX CLOSURES		CLOSURE SIZE		BASKET TYPE		TRAY TYPE		NUMBER OF TRAYS		CABLE STRAIN RELIEF HARDWARE KITS		NUMBER OF GROUND LUGS		INNER BASKET
		2S = X-2S Size		B = X-2S Sized Basket		X = No preinstalled tray L = X-2S Tray Loaded with splice modules		0 1 6		2 4 6		0 2 6		X = No Inner Basket

Apex® X-2S Sealed Splice Closure

Splice Trays and Splice Modules

Apex X-2S closures utilize X-2S size splice trays. Trays can be ordered fully loaded or half loaded with splice modules. For “rollable” type ribbon such as AFL’s SpiderWeb Ribbon, trays can be fully loaded for 24 mass splices, or 288 fibers per tray. For standard ribbon, AFL recommends half loaded for 6 mass splices single-stacked, or 72 fibers.



Ordering Information

DESCRIPTION	TRAY CAPACITY		AFL NO.
	SINGLE	MASS	
X-2S Tray Loaded with One Splice Module	18	72	AX-TRAY-2S-1
X-2S Tray Fully Loaded with Two Splice Modules (288 fibers per tray only recommended for rollable ribbon, e.g. AFL SWR)	36	288	AX-TRAY-2S-2
Additional splice module (18 single fusion triple stacked, 12 mass fusion double stacked, 6 mechanical) – Pack of 20	-	-	AX-TRAY-MOD-20
X-2S Tray Empty	-	-	AX-TRAY-2S-E

*288 fibers per tray with mass fusion double-stacking (1728 total closure capacity) only recommended for 200 um type rollable ribbon. For 250 um, cut capacity in half with single-stacking

Dimensions

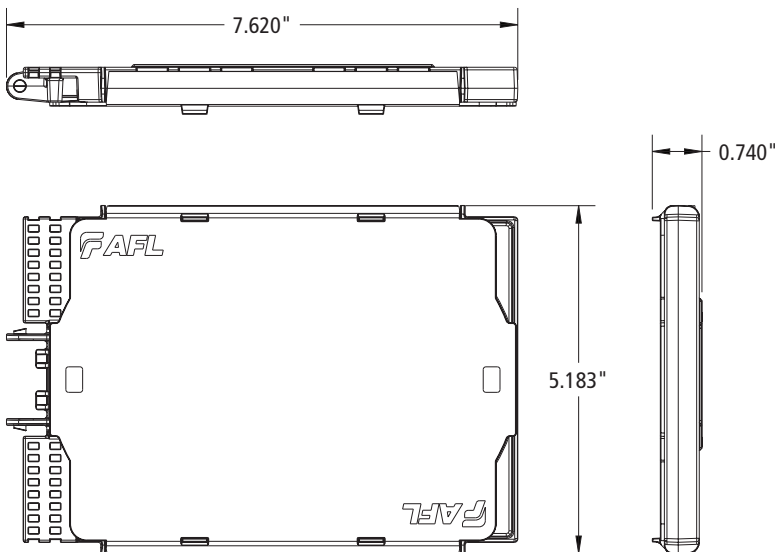

Apex® X-2S Sealed Splice Closure

Slack Storage Basket and Accessories

The Apex X-2S slack storage basket is molded with a rounded cross section to efficiently maximize space inside of the cylindrical dome closure.

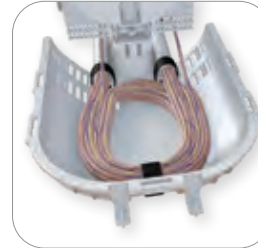

Ordering Information

DESCRIPTION	AFL NO.
Replacement slack storage basket tabs – Pack of 25	AX-KIT-BTAB-25

Slack Length

CABLE / COMPONENT	TYPE OF OPENING	STRIP LENGTH (INCHES)
WTC/SWR or Non-Matrix Ribbon	Mid Sheath	**80 - 98
	End Cut	**40 - 66
Flat Matrix Ribbon Cable	Mid Sheath	*80 - 82
	End Cut	*40 - 42
***Loose Tube Cable	Mid Sheath	**80 - 98
	End Cut	**40 - 66
STORAGE		
Each additional basket storage loop		16 - 18
Each additional splice tray service loop		17 - 18
Sheath to basket for tube retention		7 - 9
DEFINITION		
Midsheath	Slack loop in basket, service loop in tray, center cut	
End cut	Slack loop in basket, service loop in tray, to far splice	
* Ribbon minimum is slack loop in basket, no slack waterfall splicing in tray		
** Minimum no service loop in splice tray - Maximum allowing for service loop in splice tray		
*** LT storage max tubes	Additional tubes will decrease cable lengths	12 (288/24 per tube)

Apex® X-2S Sealed Splice Closure

Installation Accessories and Kits

The AFL Apex X-2S closure line has a variety of installation accessories kits to fit many applications. Additional accessories not listed here may be available by contacting AFL.

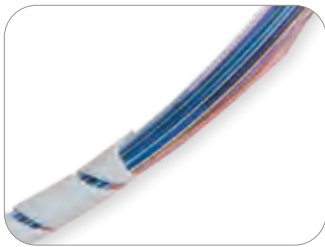

Silicone Spiral Wrap



Foam Retention



Apex® Aerial Hanger Bracket



Apex® Pole/Wall Mount

Ordering Information

DESCRIPTION	AFL NO.
Aerial strand mount hanger kit	AX-KIT-AERIAL-1
Pole/wall mount kit	AX-BR30
1/4" Colored Mesh Transition Tubing, 250' Spool	AX-KIT-TUBE-014-XX*
Single Cable Strain Relief/Attachment Kit	AX-KIT-CBLSTRN
Multi-Drop Cable Entry Kit (fits up to 4 cables 0.20" to 0.39" in diameter or flat drop cable)	AX-KIT-DROP-4
X-2 and X-2S Dome to Base O-Ring Replacement Kit	AX-KIT-ORING-2
X-2 and X-2S O-Ring Grease, Pack of 10	AX-KIT-GREASE-10
X-2 and X-2S Dome to Base Locking Ring Clamp Replacement Kit	AX-KIT-CLAMP-2
X-2 and X-2S Wedge Replacement Kit	AX-KIT-WEDGE-2
X-2 and X-2S Installation Stand	FC104649
Apex X-2 and X-2S Inner Base Gel Replacement Kit	AX-KIT-GEL-2
Apex X-2S Dome Replacement Kit	AX-KIT-DOME-2S
WTC-SWR Bundle Splice Tray Retention Kit - Includes 25 foam grommets for retaining SWR bundles to splice trays	HW000406
Silicone Spiral Wrap, 5.5 Foot Length	FC001657
Velcro, 75 Foot Length Roll – For securing SWR bundles in the slack basket	FC001759
Apex Cable Bonding Kit (Bonds armored cable sheath to ground) – Alligator clip on one end, eyelet on other end – Pack of 10	AX-KIT-GROUND-10

*Replace "XX" with any of the following for colors per the TIA-598 color code - BL, OR, GR, BR, SL, WH, RD, BK, YL, VI, RS or AQ

Apex® X-2S Sealed Splice Closure

Splitter Splice Trays

Passive optical splitters, or PLCs (Planar Lightwave Circuits), can be provided preinstalled into the Apex X-2S splice tray. PLCs can either be installed and splice within the same tray, or provided with a separate dedicated tray for splicing, with fibers routed between trays using protective tubing. A third option provides one additional tray to separate input and output fiber splicing.

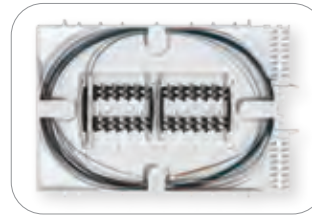

Ordering Information

DESCRIPTION	SPLIT RATIO	AFL NO.
X-2S Tray with Four Splice Modules, (1) 1x2 PLC Splitter	1x2	AX-TRAY-2S-12-1
X-2S Tray with Two Splice Modules, (1) 1x4 PLC Splitter	1x4	AX-TRAY-2S-14-1
X-2S Tray with Two Splice Modules, (1) 1x8 PLC Splitter	1x8	AX-TRAY-2S-18-1
X-2S Tray with Two Splice Modules, (1) 1x16 PLC Splitter	1x16	AX-TRAY-2S-116-1
X-2S Tray with Two Splice Modules, (1) 1x32 PLC Splitter	1x32	AX-TRAY-2S-132-1
X-2S Tray with (1) 1x2 PLC Splitter and Separate Splicing Tray with Two Splice Modules	1x2	AX-TRAY-2S-12-2
X-2S Tray with (1) 1x4 PLC Splitter and Separate Splicing Tray with Two Splice Modules	1x4	AX-TRAY-2S-14-2
X-2S Tray with (1) 1x8 PLC Splitter and Separate Splicing Tray with Two Splice Modules	1x8	AX-TRAY-2S-18-2
X-2S Tray with (1) 1x16 PLC Splitter and Separate Splicing Tray with Two Splice Modules	1x16	AX-TRAY-2S-116-2
X-2S Tray with (1) 1x32 PLC Splitter and Separate Splicing Tray with Two Splice Modules	1x32	AX-TRAY-2S-132-2
X-2S Tray with (1) 1x2 PLC Splitter and 2 Separate Splicing Trays with Two Splice Modules each	1x2	AX-TRAY-2S-12-3
X-2S Tray with (1) 1x4 PLC Splitter and 2 Separate Splicing Trays with Two Splice Modules each	1x4	AX-TRAY-2S-14-3
X-2S Tray with (1) 1x8 PLC Splitter and 2 Separate Splicing Trays with Two Splice Modules each	1x8	AX-TRAY-2S-18-3
X-2S Tray with (1) 1x16 PLC Splitter and 2 Separate Splicing Trays with Two Splice Modules each	1x16	AX-TRAY-2S-116-3
X-2S Tray with (1) 1x32 PLC Splitter and 2 Separate Splicing Trays with Two Splice Modules each	1x32	AX-TRAY-2S-132-3

Relevant Standards

GOVERNING BODY	STANDARD CODE
Telcordia	GR-771



Expandable to support various cable diameters



Ease of installation (no tapes, washers, or glue)



Multiple layers of sealing protection

LightGuard® Peel and Seal Grommet Systems for Sealed Fiber Optic Closures

AFL's cable sealing grommet technology for the LightGuard (LG) Sealed Fiber Optic Closures improves sealing technology utilizing MULTICENTRIC® Grommets that do away with time-consuming tasks such as installing washers and messy sealing tapes for cable entry. MULTICENTRIC Grommets are designed to accept a wide range of cable diameters, eliminating the need to stock a variety of diameter-specific grommet kits.

Conversion kits for old LG-100, LG-200, and LG-300 closures allows for "Peel and Seal" grommet technology to be used without changing out the existing closure.

Features

- All Peel and Seal Grommet Systems support loose tube, core tube, dielectric and armored cable designs
- Installation and re-entry using common hand tools
- Accepts a wide range of cable diameters
- Fast and easy to install
- Fits existing AFL LightGuard sealed closures
- Fully sealed to protect fiber and splices ensuring longevity
- Full conversion kits and dual cable entry port kits



Single



Dual



Quad

Ordering information

SEALED CLOSURE FULL CONVERSION KITS (SINGLE AXIS CABLE ENTRY)

DESCRIPTION	AFL NO.
3 Port Drop Grommet (LG-150/250)	FC000655
Dual Express Grommets for LG-350	FC000337
Quad Express Grommets for LG-350	FC000421
Single Cable Grommet Kit, Drop Port	FC000628
4 Port Drop Grommet (LG-350 / LG-350-AC)	FC000422
LG-350 Express Single Cable Grommet Kit	FC000726
LG-350 Drop Single Cable Grommet Kit	FC000727

Qualifications

GOVERNING BODY	STANDARD CODE
Telcordia	GR-771
Rural Utilities Service (RUS)	515

Contact AFL for further details.

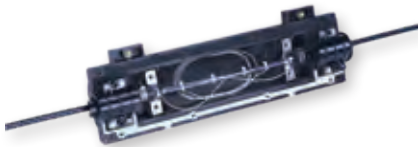
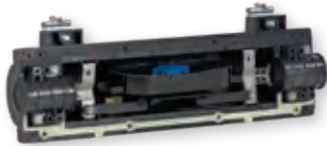

In-line Repair Closure (IRC) for repair of flat or round drop cables

Features

- Accommodates cables to 0.70" O.D for splicing and grounding/bonding
- Incorporates the Peel and Seal Grommet System, fully sealing the closure
- Includes removable, integral central splicing module and individual cable retention clamps
- Requires only a common can wrench for installation

LightGuard® 55 Sealed Fiber Optic Splice Closure

Designed with versatility in mind, the LightGuard (LG) 55 sealed closure from AFL offers a variety of solutions including repair and distribution splicing, grounding for Fiber-in-the-Loop applications, and for use as an isolation gap with armored cables. This closure accepts stranded loose tube or ribbon fiber cables in either armored or dielectric configurations and can be utilized in a butt or in-line configuration.

The LG-55 closure incorporates a unique cable clamp design sealing the cable, allowing both of the cover halves to be removed without disturbing the contents. In addition, AFL's Peel & Seal Grommet System™ is incorporated to ensure a tight fit on various cable diameters, fully sealing the closure and protecting the fiber while eliminating cumbersome tape and washers—making installation fast and easy.

Specifications

PARAMETER	VALUE
Splice Capacity (Max.)—Single, Mass, Mechanical	24, n/a, 24
Number of Splice Trays (Max.)—Single, Mass, Mechanical*	1, n/a, 1
Cable Entrance Configuration	Butt or In-line
Cable Sizes (Min. O.D. - Max. O.D.) Included Grommets Single in. (mm) Double Express Port Only in. (mm)	(2) Express Ports 0.40" - 0.70" (10.0 - 25.4) 0.26" - 0.44" (6.6 - 11.2)
Additional Grommets Quad Express Port Only in. (mm)	0.26" - 0.38" (6.6 - 9.7)
Dimensions—(L x D) in. (mm)	14.0" x 4.0" (343.0 x 101.6)
Weight—lbs. (kg)	3.0 (1.36)

Ordering Information

DESCRIPTION	MODEL NO.	AFL NO.
LG-55 FC000034-PS Fiber Optic Splice Closure—Stores up to 32 single fusion, includes 2 single cable grommets and 1 dual cable grommet kit for sealing/retention and 2 ground terminals. Splice tray and hanger brackets included. Not included: Cable Grounding Kits	LG55-U-1	FC000034-PS
LL-2425 Single Splice Tray—Stores (32) single fusion splices. Maximum of 1 trays in the LG55. Tray Included.	LL-2425	FC000053
LG-350 Single Grommet Kit (Min. 0.40" - Max. 1.00") For use in LG-55 on Express Port side.	LG-350 Exp Single Kit	FC000726
LG-350 Dual Grommet Kit (Min. 0.26" - Max. 0.44") For use in LG-55 on Express Port side.	LG-350 Exp Dual Kit	FC000337
LG-350 Quad Grommet Kit (Min. 0.26" - Max. 0.38") For use in LG-55 on Express Port side.	LG-350 Exp Quad Kit	FC000421
LG-55 Grommet Kit (1) 3 flat drop grommet (flat drop 0.31" or round cable up to 0.25") and (1) dual grommet (Min. 0.26" - Max. 0.44").	LG-55 Drop Kit	FC000807
Cable Grounding Kit (pack of 5)—Clamp-On Ground Cable Only	CGK-5	FC001091
*Mechanical Splice Kit. Includes 10 pieces of VHB tape. Used in all splice trays. Each piece holds 12 splices.	VHB Tape	FA000089



LightGuard® 55-SC Sealed Fiber Optic Splice Closure

AFL's LightGuard (LG) 55-SC sealed closure retains all the features of the LG-55, but includes a unique patching system that utilizes pre-terminated SC fiber assemblies or field-installable connectors such as the FASTConnect® SC.

An innovative solution that can be used to facilitate a link between traffic control cabinets and entrance cables, the LG-55-SC closure allows for rapid restoration and minimal damage to a fiber optic cable should an impact disable the cabinet. A breakable tie wrap secures the pre-connectorized cable to one side of the closure (traffic control cabinet), while the main entrance cable is secured with a more rugged cable clamp, allowing the system to separate during a damaging impact.

Features

- Durable cover assembly that provides protection for all internal components and acts as an interface/anchor to the cable clamps
- Unique cable clamp seal to anchor the cable to the cover assembly
- Movable sheath retention bracket keeps cable bends at a minimum
- Accommodates up to four SC/UPC connectors
- Utilizes AFL's Peel & Seal Grommet System™, ensuring a tight fit on various cable diameters while eliminating cumbersome tape and washers
- Requires only a common can wrench for installation

Specifications

PARAMETER	VALUE
Cable Sizes (Min. O.D. - Max. O.D.)	0.4" - 0.7"
Maximum Cable Entry	2 ports (one each end)
Dimensions - (L x D) in. (mm)	14" x 4" (356.0 mm x 1022.0 mm)

Ordering Information

DESCRIPTION	MODEL NO.	AFL NO.
The LG-55-SC allows for 4 SC connections to be installed. A FASTConnect or FUSEConnect, field installable connectors would be used for the connections. The field side cable is held with a tie-wrap while the signal side is secured to the closure with a hose clamp. This allows for a break-out should a vehicle make contact with a traffic box leaving the signal side cable intact.	LG-55-SC	FC000481-PS
Dual Cable Entry Port Kit – Allows two cables to enter closure from each cable port.	Dual Cable Entry Port Kit	FC000062
Quad Cable Entry Port Kits – Allows 4 cables to enter closure from each cable port	Quad Cable Entry Port Kit	FC000421
Cable Grounding Harness Kit – Includes (5) Clamp-On 9.5" long ground wires AWG #6 conductor	CGK-5	FC001091



LightGuard® 150 Sealed Fiber Optic Splice Closure

The LightGuard (LG) 150 is a sealed dome closure designed for small count fiber splicing (up to 48 single or 192 mass) in a butt configuration. Utilized in aerial or underground environments where a sealed closure is required, the LG-150 is ideal for express or ring applications and requires only a common can wrench for installation.

Features

- Supports stranded loose tube or ribbon fiber cables in either armored or dielectric configurations
- Installation and re-entry requires only a common can wrench
- Fully sealed to protect fiber and splices ensuring longevity
- Fully kitted with all parts to install five cables
- Designed and tested to Telcordia® GR-771 requirements
- Rural Utilities Service (RUS) Listed

Specifications

PARAMETER	VALUE	
Splice Capacity (Max.)—Single, Mass, Mechanical	48, 192, 48	
Number of Splice Trays (Max.)—Single, Mass, Mechanical*	4, 3, 4	
Cable Entrance Configuration	Butt	
Cables	5	
Cable Sizes (Min. O.D. - Max. O.D.) Included Grommets	(2) Express Ports	(3) Drop Ports
Single in. (mm)	0.26" - 0.62" (6.6 - 15.7)	0.26" - 0.62" (6.6 - 15.7)
Additional Grommets		
(3) Flat Drop Port Only in. (mm)	n/a	0.19" x 0.34" (4.8 x 8.6) or 0.25" round (6.4)
Dimensions—(L x D) in. (mm)	18.25" x 8.75" (463.6 x 222.3)	
Weight—lbs. (kg)	10.5 (4.76)	

LightGuard® 150 Sealed Fiber Optic Splice Closure

Ordering Information

DESCRIPTION	AFL NO.
LG-150-U-0 Fiber Optic Splice Closure—Stores 48 single fusion or 192 mass fusion, includes (5) cable kits for sealing/retention and (2) ground terminals with removable bond. Not included: Splice Trays, Cable Grounding Kits or Hanger Brackets	FC000001-PS
LL-2450 Single Splice Tray—Stores (12) single fusion splices. Maximum of 4 trays in the LG150	91957-00
LL-4850 Mass Splice Tray—Stores (8) mass fusion splices (96 F). Maximum of 4 trays in the LG-150	91958-00
LL-1248 Universal Splice Tray—Stores (12) single fusion splices or (8) mass fusion splices (96 F), or *Mechanical. Max. of 4 trays in the LG-150	911221-00-00
LG-150/250 Single Grommet Kit (Min. 0.26" - Max. 0.62")	FC000704
LG-150/250 3 Flat Drop Grommet Kit (standard flat drop 0.31" or round cable up to 0.25")	FC000655
Universal Aerial Strand Hanger Kit—For use with LG-150/250/350	FC000006
Extended Offset Strand Hanger Kit—For use with LG-150/250/350	FC000208
Pole or Wall Mount Bracket—For use with LG-150/250/350	LGBR-30
OPGW Dual Cable Bracket Kit for use only when installing closure on OPGW cable—For use with LG-150/250/350	FC000683
OPGW Quad Cable Bracket Kit—For use with LG-150/250	FC000746
1x6 Fiber Router Kit with furcation tubes	FC000070
CGK-5 Cable Grounding Kit (pack of 5)—Clamp-On Ground Cable Only	FC001091
*Mechanical Splice Kit. Includes 10 pieces of VHB tape. Used in all splice trays. Each piece holds 12 splices.	FA000089
O-Ring and Lock Ring Kit—For use with LG-150/250	FC000771

* See Accessory Specifications.
See Splice Tray Specifications.

Qualifications

GOVERNING BODY	STANDARD CODE
Telcordia	GR-771
Rural Utilities Service (RUS)	Listed

Contact AFL for further details.



LightGuard® 250 Sealed Fiber Optic Splice Closure

The LightGuard (LG) 250 is a sealed dome closure designed for medium count fiber splicing (up to 144 single or 432 mass) in a butt configuration. Utilized in aerial or underground environments where a sealed closure is required, the LG-250 is ideal for express or ring applications and requires only a common can wrench for installation.

Features

- Supports stranded loose tube or ribbon fiber cables in either armored or dielectric configurations
- Installation and re-entry requires only a common can wrench
- Fully sealed to protect fiber and splices ensuring longevity
- Fully kitted with all parts to install five cables

Specifications

PARAMETER	VALUE	
Splice Capacity (Max.)—Single, Mass, Mechanical	144, 432, 48	
Number of Splice Trays (Max.)—Single, Mass, Mechanical*	4, 3, 4	
Cable Entrance Configuration	Butt	
Cables	5	
Cable Sizes (Min. O.D. - Max. O.D.)		
Included Grommets Single in. (mm)	(2) Express Ports 0.26" - 0.62" (6.6 - 15.7)	(3) Drop Ports 0.26" - 0.62" (6.6 - 15.7)
Additional Grommets (3) Flat Drop Port Only in. (mm)	n/a	0.19" x 0.34" (4.8 x 8.6) or 0.25" round (6.4)
Dimensions—(L x D) in. (mm)	19.0" x 8.75" (463.6 x 222.3)	
Weight—lbs. (kg)	10.5 (4.76)	

continued
→

LightGuard® 250 Sealed Fiber Optic Splice Closure

Ordering Information

DESCRIPTION	AFL NO.
LG-250-U-0 Fiber Optic Splice Closure—Stores 144 single fusion or 432 mass fusion, includes (5) cable kits for sealing/retention and (2) ground terminals with removable bond. Not included: Splice Trays, Cable Grounding Kits or Hanger Brackets	FC000002-PS
LL-2400 Single Splice Tray—Stores (24) single fusion splices. Maximum of 4 trays in the LG-250.	91710-06
LL-2448 Universal Splice Tray—Stores (24) single fusion or (4) mass fusion splices (48 F). Maximum of 3 trays in the LG-250	911289-00-02
LL-4848 Mass Splice Tray—Stores (12) mass fusion splices (144 F). Maximum of 3 trays in the LG-250	911437-00-02
LL-2448-48S Single Splice Tray—Stores (48) single fusion splices. Maximum of 3 trays in the LG-250	FA000045
LG-150/250 Single Grommet Kit (Min. 0.26" - Max. 0.62")	FC000704
LG-150/250 3 Flat Drop Grommet Kit (standard flat drop 0.31" or round cable up to 0.25")	FC000655
Universal Aerial Strand Hanger Kit—For use with LG-150/250/350	FC000006
Extended Offset Strand Hanger Kit—For use with LG-150/250/350	FC000208
PWK Pole or Wall Mount Bracket—For use with LG-150/250/350	LGBR-30
OPGW Dual Cable Bracket Kit—For use with LG-150/250/350	FC000683
OPGW Quad Cable Bracket Kit—For use with LG-150/250	FC000746
1x6 Fiber Router Kit with furcation tubes	FC000070
CGK-5 Cable Grounding Kit (pack of 5)—Clamp-On Ground Cable Only	FC001091
*Mechanical Splice Kit. Includes 10 pieces of VHB tape. Used in all splice trays. Each piece holds 12 splices.	FA000089
O-Ring and Lock Ring Kit—For use with LG-150/2	FC000771

* See Accessory Specifications.
See Splice Tray Specifications.

Qualifications

GOVERNING BODY	STANDARD CODE
Telcordia	GR-771
Rural Utilities Service (RUS)	Listed

Contact AFL for further details.



CWDM 4-Channel Mini Module



CWDM 8-Channel Mini Module

Thin Film Filter (TFF) Compact Series CWDM

AFL's TFF compact series CWDM modules deliver reliable performance and flexibility in every network application – from cellular backhaul and metro Ethernet to access and security. With its reduced package size, this new outside plant CWDM module has added flexibility, making deployment options more convenient.

This CWDM series is based on proven Thin Film Filter technology, offering low insertion loss and high thermal stability over the entire outside plant operating temperature range. Numerous configurations are available to meet unique needs and support new or existing network architectures. Typical options include a variety of configurations (mux, demux, and balanced), upgrade ports (1310, C-Band, and others), test/monitoring ports and multiple termination options.

Features

- Low insertion loss
- Compact size
- High thermal stability

Applications

- CWDM systems
- Metro Ethernet / access networks
- Cellular backhaul networks

Specifications

PARAMETER	UNIT	WITHOUT UPGRADE PORT		WITH 1310 NM UPGRADE PORT	
		4 Channel	8 Channel	4 Channel	8 Channel
Operating Wavelength	nm	1471~1611			
Channel Spacing	nm	20			
Center Wavelength	nm	Customer specified			
Pass Band	nm	± 6.5			
1310 Upgrade Port Pass Band	nm	—		1270~1350	
1310 Upgrade Port Insertion Loss	dB	—		1.0	
CWDM Channel Insertion Loss	dB	≤ 2.0	≤ 2.5	≤ 2.6	≤ 3.4
CWDM Adjacent Channel Isolation	dB	≥ 30			
CWDM Non-adjacent Channel Isolation	dB	≥ 45			
PDL	dB	≤ 0.2			
PMD	ps	≤ 0.1		≤ 0.25	
Return Loss	dB	≥ 45			
Directivity	dB	≥ 50			
Maximum Input Power	mW	≤ 300			
Package Size	Mm	60 (l) x 35 (w) x 6 (d)		70 (l) x 45 (w) x 9 (d)	

* Actual optical specifications will vary based on product configuration

1. Higher and lower channel counts available

Qualifications

GOVERNING BODY	STANDARD CODE	COMPONENT
Telcordia	GR-1221-CORE	Cable
RoHS	6/6 Compliant	Cable

Temperature Specifications

TEMPERATURE RANGE	
Operation Temperature	-40°C ~ to +85°C

Contact AFL for further details.

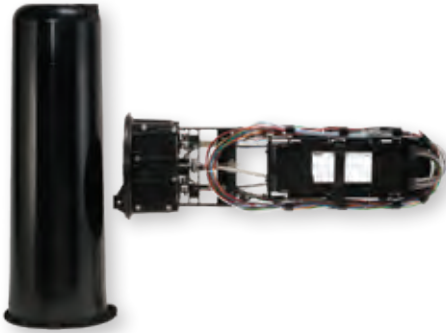

LightGuard® 350 Sealed Fiber Optic Splice Closure

The LightGuard (LG) 350 is a sealed dome closure designed for large count fiber splicing (up to 480 single or 1152 mass) in a butt configuration. Utilized in aerial or underground environments where a sealed closure is required, the LG-350 is ideal for express, ring or long haul applications and requires only a common can wrench for installation.

Features

- Supports stranded loose tube or ribbon fiber cables in either armored or dielectric configurations
- Installation and re-entry requires only a common can wrench
- Fully sealed to protect fiber and splices ensuring longevity
- Fully kitted with all parts to install five cables

Specifications

PARAMETER	VALUE	
Splice Capacity (Max.)—Single, Mass, Mechanical	480, 1152, 108	
Number of Splice Trays (Max.)—Single, Mass, Mechanical*	12, 8, 8	
Cable Entrance Configuration	Butt	
Cables	5 to 11	
Cable Sizes (Min. O.D. - Max. O.D.)	(2) Express Ports	(3) Drop Ports
Included Grommets	0.40" - 1.00"	0.26" - 0.80"
Single in. (mm)	(10.0 - 25.4)	(6.6 - 20.0)
Additional Grommets	0.26" - 0.44"	
Dual Express Port Only in. (mm)	(6.6 - 11.2)	
Quad Express Port Only in. (mm)	0.26" - 0.38"	
	(6.6 - 9.7)	
(4) Flat Drop Port Only in. (mm)		0.19" x 0.34"
		(4.8 x 8.6) or
		0.25" round (6.4)
Dimensions—(L x D) in. (mm)	28.0" x 10.0" (710.0 x 254.0)	
Weight - lbs. (kg)	16 (7.26)	

continued
→

LightGuard® 350 Sealed Fiber Optic Splice Closure

Ordering Information

DESCRIPTION	AFL NO.
LG-350-U-0 Fiber Optic Splice Closure – Stores 480 single fusion or 1152 mass fusion, includes (5) cable kits for sealing/retention and (2) ground terminals with removable bond. Not included: Splice Trays, Cable Grounding Kits or Hanger Brackets	FC000009-PS
LL-2400 Single Splice Tray – Stores (24) single fusion splices. Maximum of 12 trays in the LG-350	91710-06
LL-2448 Universal Splice Tray – Stores (24) single fusion or (4) mass fusion splices (48 F). Maximum of 8 trays in the LG-350	911289-00-02
LL-4848 Mass Splice Tray – Stores (12) mass fusion splices (144 F). Maximum of 8 trays in the LG-350	911437-00-02
LL-2448-48S Single Splice Tray – Stores (48) single fusion splices. Maximum of 8 trays in the LG-350	FA000045
LL-4896 Universal Splice Tray – Stores (96) single fusion splices or (24) mass fusion splices (288 F). Maximum of 5 trays in the LG-350	911676-00-02
LL-4896-R Mass Splice Tray – Stores (24) mass fusion splices (288 F). Maximum of 5 trays in the LG-350	FA000022
LL-4896-L Single Splice Tray – Stores (96) single fusion splices. Maximum of 5 trays in the LG-350	FA000023
LL-7644 Universal Splice Tray – Stores (60) single fusion or (288) mass fusion splices or a combination of both in an easy-to-use, deep splice tray. For use with LG-350SD	FA000044
LL-7060 Splice Tray – Stores (60) single fusion splices in an easy-to-use, deep splice tray – For use in LG-350	FA000042
LL-7144 Splice Tray – Stores (288) mass fusion splices in an easy-to-use, deep splice tray – For use in LG-350	FA000043
LG-350 Single Grommet Kit (Min. 0.40" - Max. 1.00") – For use in LG-350/AC/SD on Express Port side	FC000726
LG-350 Dual Grommet Kit (Min. 0.26" - Max. 0.44") – For use in LG-350/AC/SD on Express Port side	FC000337
LG-350 Quad Grommet Kit (Min. 0.26" - Max. 0.38") – For use in LG-350/AC/SD on Express Port side	FC000421
LG-350 Single Grommet Kit (Min. 0.26" - Max. 0.80") – For use in LG-350/AC/SD on Drop Port side	FC000727
LG-350 Drop 4 Flat Drop Grommet Kit – For use with standard flat drop cable and round cable up to 0.25" O.D.	FC000422
Universal Aerial Strand Hanger Kit – For use with LG-150/250/350	FC000006
Extended Offset Strand Hanger Kit – For use with LG-150/250/350	FC000208
PWK Pole or Wall Mount Bracket – For use with LG-150/250/350	LGBR-30
OPGW Dual Cable Bracket Kit – For use with LG-150/250/350	FC000683
OPGW Quad Cable Bracket Kit for use when installing Sealed Closures – For use with LG-350	FC000747
1x6 Fiber Router Kit with furcation tubes	FC000070
CGK-5 Cable Grounding Kit (pack of 5) – Clamp-On Ground Cable Only	FC001091
*Mechanical Splice Kit. Includes 10 pieces of VHB tape. Used in all splice trays. Each piece holds 12 splices.	FA000089
O-Ring and Lock Ring Kit – For use with LG-350/350AC/SD	FC000775

* See Accessory Specifications. See Splice Tray Specifications.
Micro Duct Grommets available. Please call Customer Service for details.

Qualifications

GOVERNING BODY	STANDARD CODE
Telcordia	GR-771
Rural Utilities Service (RUS)	Listed

Contact AFL for further details.



LightGuard® 350-AC Drop Access Sealed Fiber Optic Splice Closure

The LightGuard (LG) 350-AC is a sealed dome closure designed for medium count fiber splicing (up to 144 single or 432 mass) in a butt configuration where space may be limited. Utilized in aerial or underground environments where a sealed closure is required, the LG-350-AC is designed for “drop access” applications providing access for up to 12 drops. The LG-350-AC is ideal for Fiber-to-the-Home installations in small hand-hole application and requires only a common can wrench for installation.

Features

- Less than 20" overall length; ideal for small hand-holes
- Supports stranded loose tube or ribbon fiber cables in either armored or dielectric configurations
- Installation and re-entry requires only a common can wrench
- Fully sealed to protect fiber and splices ensuring longevity
- Fully kitted with all parts to install two cables and up to 12 drops

Specifications

PARAMETER	VALUE	
Splice Capacity (Max.)—Single, Mass, Mechanical	144, 432, 48	
Number of Splice Trays (Max.) - Single , Mass, Mechanical*	4, 3, 4	
Cable Entrance Configuration	Butt	
Cables	2 to 8 Express with up to 12 Drop	
Cable Sizes (Min. O.D. - Max. O.D.)	(2) Express Ports	(3) Drop Ports
Included Grommets	0.40" - 1.00"	(4 port) 0.26" - 0.80"
Single in. (mm)	(10.0 - 25.4)	
(4) Flat Drop Only in. (mm)		(6.6 - 20.0)
Additional Grommets		
Dual Express Port Only in. (mm)	0.26" - 0.44"	
	(6.6 - 11.2)	
Quad Express Port Only in. (mm)	0.26" - 0.38"	
	(6.6 - 9.7)	
(4) Flat Drop Port Only in. (mm)		0.19" x 0.34"
		(4.8 x 8.6) or
		0.25" round (6.4)
Dimensions - (L x D) in. (mm)	19.8" x 10.0" (503.0 x 254.0)	
Weight - lbs. (kg)	12.0 (5.44)	

continued
→

LightGuard® 350-AC Drop Access Sealed Fiber Optic Splice Closure

Ordering Information

DESCRIPTION	AFL NO.
LG-350-AC Fiber Optic Splice Closure—Stores 144 single fusion or 432 mass fusion, includes (2) Express cable kits and (12) Drop cable kits for sealing/retention and (2) ground terminals with removable bond. Included: (1) LL-4808L Splice Tray Not included: Cable Grounding Kits, or Hanger Brackets	FC000412
LL-4808L-R Universal Splice Tray—Stores (36) single fusion splices or (12) mass fusion splices (144 F). Maximum of 4 trays in the LG-350-AC.	FA000037
LL-4808-R Mass Splice Tray—Stores (12) mass fusion splices (144 F). Maximum of 4 trays in the LG-350-AC	FA000020
LL-4808-L Single Splice Tray—Stores (36) single fusion splices. Maximum of 4 trays in the LG-350-AC	FA000021
LG-350 Single Grommet Kit (Min. 0.40" - Max. 1.00")—For use in LG-55/LG-350/LG-350-AC on Express Port side	FC000726
LG-350 Dual Grommet Kit (Min. 0.26" - Max. 0.44")—For use in LG-55/LG-350/LG-350-AC on Express Port side	FC000337
LG-350 Quad Grommet Kit (Min. 0.26" - Max. 0.38")—For use in LG-55/LG-350/LG-350-AC on Express Port side	FC000421
LG-350 Single Grommet Kit (Min. 0.26" - Max. 0.80")—For use in LG-350/AC/SD on Drop Port side	FC000727
LG-350 Drop 4 Flat Drop Grommet Kit—For use with standard flat drop cable and round cable up to 0.25" O.D.	FC000422
Universal Aerial Strand Hanger Kit—For use with LG-150/250/350	FC000006
Extended Offset Strand Hanger Kit—For use with LG-150/250/350	FC000208
PWK Pole or Wall Mount Bracket—For use with LG-150/250/350	LGBR-30
OPGW Dual Cable Bracket Kit—For use with LG-150/250/350	FC000683
1x6 Fiber Router Kit with furcation tubes	FC000070
CGK-5 Cable Grounding Kit (pack of 5)—Clamp-On Ground Cable Only	FC001091
*Mechanical Splice Kit. Includes 10 pieces of VHB tape. Used in all splice trays. Each piece holds 12 splices.	FA000089
LG-350 O-Ring and Lock Ring Kit—For use with LG-350/AC/SD	FC000775

* See Accessory Specifications.
See Splice Tray Specifications.

Qualifications

GOVERNING BODY	STANDARD CODE
Telcordia	GR-771
Rural Utilities Service (RUS)	Listed

Contact AFL for further details.



LightGuard® 350XL Sealed Fiber Optic Splice Closure

The LightGuard (LG) 350XL is a sealed dome closure designed for large count fiber splicing (up to 864 single or 2592 mass) in a butt configuration. Utilized in aerial or underground environments where a sealed closure is required, the LG-350XL is ideal for high fiber count splicing and requires only a common can wrench for installation. A Phillips head screw is used to secure the tray support to the basket.

Features

- Supports stranded loose tube or ribbon fiber cables in either armored or dielectric configurations
- Installation and re-entry requires only a common can wrench
- Fully sealed to protect fiber and splices ensuring longevity
- Fully kitted with all parts to install five cables
- Accommodates up to 7 cables
- Oversized basket allows multiple configurations of slack storage
- O-Ring and Locking Ring for increased protection

Specifications

PARAMETER	VALUE	
Splice Capacity (Max.)—Single, Mass, Mechanical	864, 2592, 288	
Number of Splice Trays (Max.)—Single, Mass, Mechanical*	9, 9, 9	
Cable Entrance Configuration	Butt	
Cables	5 to 7	
Cable Sizes (Min. O.D. - Max. O.D.)	(2) Express Ports	(3) Drop Ports
Included Grommets	0.40" - 1.18"	0.30" - 1.08"
Single in. (mm)	(10.0 - 30.0)	(7.6 - 27.4)
Additional Grommets	0.38" - 0.56"	
Dual Exp. Port Only in. (mm)	(9.7 - 14.2)	
Dimensions - (L x D) in. (mm)	31.0" x 12.00" (788.5 x 305.0)	
Weight - lbs. (kg)	25.0 (11.3)	

continued
→

LightGuard® 350XL Sealed Fiber Optic Splice Closure

Ordering Information

DESCRIPTION	AFL NO.
LG-350XL-U-0 Fiber Optic Splice Closure – Stores 864 single fusion or 2592 mass fusion, includes (5) cable kits for sealing/retention and (2) ground terminals with removable bond. Not included: Splice Trays, Cable Grounding Kits or Hanger Brackets	FC000010-PS
LL-4896 Universal Splice Tray – Stores (96) single fusion splices or (24) mass fusion splices (288 F), *Mechanical. Max. of 9 trays in the LG-350XL	911676-00-02
LL-4896-R Mass Splice Tray – Stores (24) mass fusion splices (288 F). Max. of 9 trays in the LG-350XL	FA000022
LL-4896-L Single Splice Tray – Stores (96) single fusion splices. Max. of 9 trays in the LG-350XL	FA000023
LG-350XL Single Grommet Kit (Min. 0.40" - Max. 1.18") – For use in LG-350XL on Express Port side	FC000870
LG-350XL Dual Grommet Kit (Min. 0.38" - Max. 0.56") – For use in LG-350XL on Express Port side	FC000688
LG-350XL Single Grommet Kit (Min. 0.30" - Max. 1.08") – For use in LG-350XL on Drop Port side	FC000871
LG-350XL Drop 4 Flat Drop Grommet Kit – For use with standard flat drop cable and round cable up to 0.25" O.D.	FC001713
Strand Mount Hanger Bracket – For use with LG-350XL in strand or vault mounting	912215-00-00
1x6 Fiber Router Kit with furcation tubes	FC000070
CGK-5 Cable Grounding Kit (pack of 5) – Clamp-On Ground Cable Only	FC001091
*Mechanical Splice Kit. Includes 10 pieces of VHB tape. Used in all splice trays. Each piece holds 12 splices.	FA000089
O-Ring and Lock Ring Kit – For use with LG-350XL	FC001328
Transition tubing 16.25" long – Used to transport ribbon to the splice trays. (20) per kit	FC001372

* See LL-4896 Splice Tray Specifications.

Qualifications

GOVERNING BODY	STANDARD CODE
Telcordia	GR-771
Rural Utilities Service (RUS)	Listed

Contact AFL for further details.

LightGuard® Sealed Splice Closure Accessories



Dual Express Grommets for LG-350XL

Used on the express side of the LG-350XL closure for installing additional branches. Use the drop ports for the express cable while the express ports may be used to introduce small branch cables. Minimum cable diameter is 0.380" - 0.560".

Ordering Information

DESCRIPTION	AFL NO.
Dual Express Grommets for LG-350XL	FC000688



Dual Express Grommets

Dual and Quad Express Grommets for LG-350

Used on the express side of the LG-350 closure for installing additional branches. Use the drop ports for the express cable while the express ports may be used to introduce small branch cables. A 4-drop flat grommet may be used if drops are also required. Cable diameter for dual grommets is 0.26" - 0.44"; for quad, 0.24" - 0.382".



Quad Express Grommets

Ordering Information

DESCRIPTION	AFL NO.
Dual Express Grommets for LG-350	FC000337
Quad Express Grommets for LG-350	FC000421



4-Port Flat Drop Grommet Kit for LG-350/LG-350-AC

Used with the LG-350 and LG-350-AC Sealed Closures. Allows for quick addition of drop cables as required. Simply replace the drop port grommets with this grommet kit and install standard flat drop cable or round cable up to 0.25" in diameter.

Ordering Information

DESCRIPTION	AFL NO.
4-Port Flat Drop Grommet Kit for LG-350/LG-350-AC	FC000422



Single Cable and 3-Port Flat Drop Grommet Kit for LG-150/LG-250

Used with the LG-150 and LG-250 Sealed Closures. Allows for quick addition of drop cables as required. Simply replace the drop port grommets with this grommet kit. Both closures will accept standard flat drop cable or round cable up to 0.250" in diameter.

Ordering Information

DESCRIPTION	AFL NO.
Single Cable Grommet Kit for the LG-150/LG-250	FC000704
3-Port Flat Drop Grommet Kit for the LG-150/LG-250	FC000655

continued
→

LightGuard® Sealed Splice Closure Accessories (cont.)



Single Cable Grommet Kits for LG-350-AC and LG-350

Used with the LG-350-AC when a branch cable is required with the drop cables. May also be used for with the LG-350 as replacement grommets. Simply remove the flat drop grommet and replace with the single cable grommets.

Ordering Information

DESCRIPTION	AFL NO.
Single Cable Grommet Kit, Drop Port for LG-350-AC	FC000628
Express Single Cable Grommet Kit for LG-350	FC000726
Drop Single Cable Grommet Kit for LG-350	FC000727



OPGW Cable Bracket for LG-150/LG-250/LG-350

Attaches to the outer grounding studs of the LG-150/LG-250 or LG-350 Sealed Closures. Stainless steel hose clamps secure the OPGW cable to the bracket preventing twisting or movement.

Ordering Information

DESCRIPTION	AFL NO.
OPGW Cable Bracket for the LG-150/LG-250/LG-350 for 2 cables.	FC000683
OPGW Cable Bracket Kit for use when installing Sealed Closures (LG-150/LG-250) to 4 OPGW Cables.	FC000746
OPGW Cable Bracket Kit for use when installing Sealed Closures (LG-350) to 4 OPGW Cables.	FC000747



Pole/Wall Mount Bracket for LG-150/LG-250/LG-350

Used with the LG-150, LG-250, LG-350 and LG-350-AC to secure the closures onto poles or walls in a vertical orientation. Slots on the brackets allow for strapping onto steel or cement poles.

Ordering Information

DESCRIPTION	AFL NO.
Pole/Wall Mount Bracket for LG-150/LG-250/LG-350/LG-350-AC	FC000592



Universal Aerial Bracket and Extended Offset Bracket

Used with the LG-150, LG-250, LG-350 and LG-350-AC for mounting on aerial or messengers.

Ordering Information

DESCRIPTION	AFL NO.
Universal Aerial Bracket for LG-150/LG-250/LG-350/LG-350-AC	FC000006
Extended Offset Bracket	FC000208

continued
→

LightGuard® Sealed Splice Closure Accessories (cont.)



Strand Mount Hanger Bracket for LG-350XL

Used with the LG-350XL.

Ordering Information

DESCRIPTION	AFL NO.
Strand Mount Hanger Bracket – For use with LG-350XL	912215-00-00



Cable Ground Kits

Used with the LG-150, LG-250 and LG-350.

Ordering Information

DESCRIPTION	AFL NO.
Cable Grounding Kit – Includes harness and hose clamp. One kit needed per cable entry. For use with LG-150/250/350.	FC000003
Cable Grounding Harness Kit – Includes (4) 8" ground harnesses constructed of #6 AWG conductor	FC000024
Cable Grounding Kit (pack of 5) – Includes harness and hose clamp. For use with LG-150/250/350.	FC000040



O-Ring Replacement Kits

Used with the LG-150, LG-250, LG-350 and LG-350XL.

Ordering Information

DESCRIPTION	AFL NO.
O-Ring Replacement Kit – For use with LG-150/250	FC000004
O-Ring Replacement Kit – For use with LG-300XL	FC000016
O-Ring Replacement Kit – For use with LG-350.	912231-00-00

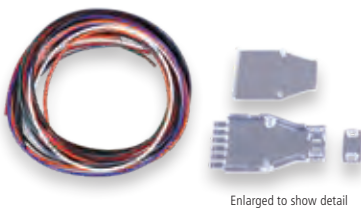

1x6 Cable Router Kit

Used with the LG-150, LG-250, LG-350 and LG-350-AC.

Ordering Information

DESCRIPTION	AFL NO.
1X6 Cable Router Kit	FC000070



LightGuard® Aerial Weathertight Fiber Optic Splice Closures

The AFL family of Aerial Weathertight Splice Closures is designed to provide a cost-effective solution for your aerial splicing needs. Quality engineering reduces the installation time, training and complexity associated with fiber splicing in the field. The closures have all been designed to be installed without the need for special tools, heat, adhesives, drills or any powered equipment. Durable and easy to install, these closures will improve productivity, reduce labor expenses and last the life of the plant.

Features

- Individual, patented, self-sizing cable grommets and strength member tie downs provide for cable additions without disturbing those previously installed
- Unique tongue-in-groove closure seal and back-to-back grommet design provides for a weathertight and insect seal
- Closures are re-enterable without the need for any re-entry kits and require only a common can wrench for installation

Specifications

PARAMETER	LG-410-U-0	LG-420-U-0	LG-500-U-0	LG-600-U-0
Splice Capacity (Max.) – Single, Mass, Mechanical	144, 432, 36	12, 48, 12	144, 432, 36	384, 1152, 96
Splice Tray Capacity – Single, Mass	4, 2	n/a, n/a	4, 2	12, 8, 8
Cable Ports	4-8	4-6	4-8	6 (3 per end)
Cable Entrance	In-line, Butt	In-line (taut sheath)	In-line, Butt	In-line, Butt
Cable Sizes (O.D.)	4 @ 0.3-0.82" Up to 8 with Dual Grommet Kits 4 @ 0.27-0.53" 4 @ 0.38-0.70"	4 @ 0.3-0.82" Up to 6 with Dual Grommet Kits 2 @ 0.27-0.53" 2 @ 0.38-0.70"	4 @ 0.3-0.82" Up to 8 with Dual Grommet Kits 4 @ 0.27-0.53" 4 @ 0.38-0.70"	6 @ 0.44 - 1.0" Up to 12 with Dual Grommet Kits 6 @ 0.4-0.6" 6 @ 0.7-0.9"
CLOSURE TEST ^{1,2}				
- Cable Retention (100 lbs.)	Passed	Passed	Passed	Passed
- Impact Resistance (0-40 °C)	Passed	Passed	Passed	Passed
- Chemical Resistance	Passed	Passed	Passed	Passed
- Cable Flexing	Passed	Passed	Passed	Passed
- Dust (Weather Tightness)	Passed	Passed	Passed	Passed
- Driving Rain	Passed	Passed	Passed	Passed
- Rodent Test	Passed	Passed	Passed	Passed
Dimensions (L x W x D) in. (cm)	36.00 x 8.00 x 4.00 (91.44 x 20.32 x 10.16)	36.00 x 8.00 x 4.00 (91.44 x 20.32 x 10.16)	27.00 x 8.25 x 4.00 (68.58 x 20.96 x 10.16)	27.00 x 11.25 x 7.50 (68.58 x 28.58 x 19.05)
Weight lbs. (kg)	8.5 (3.86)	8.5 (3.86)	6.4 (2.90)	18 (8.16)

- NOTES:**
1. Tested to Telcordia GR-771-Core and Aerial Strand requirements
 2. Not all Telcordia tests are listed due to space constraints; All closures are designed and tested to appropriate aerial test requirements

Qualifications

GOVERNING BODY	STANDARD CODE
Telcordia	GR-771
Rural Utilities Service (RUS)	Listed

Contact AFL for further details.



LightGuard® 410 Aerial Weathertight Fiber Optic Splice Closure

The LightGuard (LG) 410 Aerial Weathertight Fiber Optic Splice Closure is designed for medium count fiber splicing (up to 144 single or 432 mass) in a butt or in-line configuration. Utilized in aerial applications, the LG-410 provides additional fiber bundle storage with its extended length design and requires only a common can wrench for installation.

Features

- Four individual, self-sizing grommeted cable ports (expandable to eight cable entrances)
- Patented tongue-in-groove cover seal system
- Installation and re-entry only require a common can wrench
- Cable retention clamps provide pullout
- UV-resistant engineered thermoplastic

Specifications

PARAMETER	VALUE
Splice Capacity (Max.) – Single, Mass, Mechanical	96, 288, 48
Number of Splice Trays (Max.) – Single, Mass, Mechanical*	4, 3, 4
Cable Entrance Configuration	Butt or in-line
Cables	4 to 8
Cable Sizes (Min. O.D. - Max. O.D.) Included Grommets Single in. (mm) Additional Grommets Dual Grommet in. (mm) 6-port Multi-Drop Grommet in. (mm)	(4) Cable Ports 4 @ 0.38" - 0.82" (7.6 - 20.8) Sm: 0.27" - 0.53" (6.9 - 13.5) Lg: 0.38" - 0.70" (9.5 - 17.8) 0.20" - 0.37" (5.1 - 9.4)
Dimensions – (L x D) in. (mm)	36.00" x 8.0" x 4.0" (914.0 x 203.0 x 102.0)
Weight – lbs. (kg)	8.5 (3.81)

continued
→

LightGuard® 410 Aerial Weathertight Fiber Optic Splice Closure

Ordering Information

DESCRIPTION	MODEL NO.	AFL NO.
LG-410 Aerial Weathertight Fiber Optic Splice Closure – Stores 144 single fusion or 432 mass fusion, includes (4) cable kits for sealing/retention and (2) ground terminals with removable bond, and hanger brackets. Not included: Splice Trays or Cable Grounding Kits	LG-410-U-0	FC000022
LL-2400 Single Splice Tray – Stores (24) single fusion splices. Maximum of 4 trays in the LG-410.	LL-2400	91710-06
LL-2448 Universal Splice Tray – Stores (24) single fusion or (4) mass fusion splices (48 F). Maximum of 3 trays in the LG-410.	LL-2448	911289-00-02
LL-4848 Mass Splice Tray – Stores (12) mass fusion splices (144 F). Maximum of 3 trays in the LG-410.	LL-4848	911437-00-02
LL-2448-48S Single Splice Tray – Stores (48) single fusion splices. Maximum of 3 trays in the LG-410.	LL-2448-48S	FA000045
Small Single Grommet Kit (10 pc grommet only) – (Min 0.38" - Max 0.82")	Small Single Grommet Kit (10)	911496-00-00
Small Dual Grommet Kit – Includes: (2) small dual grommets and hardware (Min 0.27" - Max 0.53" and Min 0.38" - Max 0.70")	Small Dual Grommet Kit	911386-00-01
Small Dual Grommet Kit (10 pc grommet only) – (Min 0.27" - Max 0.53" and Min 0.38" - Max 0.70")	Small Dual Grommet Kit (10)	911495-00-00
Small 6-Port Drop Cable Kit – 2 grommets with tie wrap and foam Allows six cable entries (Min 0.20" - Max 0.365" and flat drop)	Small 6 Port Drop Kit	FC000573
Large Single Grommet Kit with retention hardware (Min 0.44" - Max 1.04")	Large Single Grommet Kit	FC000623
Small 6-Port Drop Cable Kit (10 pc grommet only) (Min 0.20" - Max 0.365" and flat drop)	Small Drop Grommet Kit (10)	FC000644
Large Single Grommet Kit (10 pc grommet only) (Min 0.44" - Max 1.04")	Large Single Grommet Kit (10)	91918-00
Large Dual Grommet Expansion Kit—Includes: (2) Dual grommets and hardware (Min .40"-Max .70" and Min 0.60" - Max 0.90")	Large Dual Grommet Kit	911406-00-00
Large 6 Port Drop Cable Kit—2 Grommets with retention bracket. Allows six cable entries (Min 0.23" - Max 0.48" and flat drop)	Large 6 Port Drop Kit	FC000352
Adjustable Aerial Hanger Kit Bracket Kit (included with closure)	Adjustable Hanger LG-400/500/600	911497-00-00
Extended Offset Aerial Hanger Kit LG-400/500/600	Offset Hanger LG-400/500/600	91990-00
Retention hardware for additional cables or replacement hardware—LG-400/500/600 (no grommets)	Cable Retention Kit LG-400\500\600	FC000356
Closure Extension Kit - Used to join multiple closures for extended sheath openings required to repair cable sheath and damaged fibers	Closure Extension Kit LG-400/500/600	911499-00-00
1x6 Fiber Router Kit with furcation tubes.	1x6 Fiber Router	FC000070
Cable Grounding Kit (pack of 5)—Clamp-On Ground Cable Only	CGK-5	FC001091
*Mechanical Splice Kit. Includes 10 pieces of VHB tape. Used in all splice trays. Each piece holds 12 splices.	VHB Tape	FA000089

* See Accessory Specifications. See Splice Tray Specifications.

Qualifications

GOVERNING BODY	STANDARD CODE
Telcordia	GR-771
Rural Utilities Service (RUS)	Listed

Contact AFL for further details.



LightGuard® 420 Aerial Weathertight Fiber Optic Splice Closure

The LightGuard (LG) 420 Aerial Weathertight Fiber Optic Splice Closure is designed for taut sheath (no slack) splicing (up to 24 single or 48 mass) in an in-line configuration. Utilized in aerial applications, the LG-420 is ideal for repairing cable sheath or fibers, providing mid-span access and requires only a common can wrench for installation.

Features

- Four individual, self-sizing grommets cable ports (expandable to eight cable entrances)
- Taut Sheath splice module accommodates up to 12 fusion splices
- Protective channel allowing taut fibers or bundles to pass through the closure
- Patented tongue-in-groove cover seal system
- Installation and re-entry only require a common can wrench
- Cable retention clamps provide pullout
- UV-resistant engineered thermoplastic

Specifications

PARAMETER	VALUE
Splice Capacity (Max.) – Single, Mass, Mechanical	24, 48, 12
Number of Splice Trays (Max.) – Single, Mass, Mechanical*	Splice chips for 24F single fusion splice (incl.)
Cable Entrance Configuration	In-line (taut sheath)
Cables	4 to 8
Cable Sizes (Min. O.D. - Max. O.D.) Included Grommets Single in. (mm) Additional Grommets Dual Grommet in. (mm)	(4) Cable Ports 4 @ 0.38" - 0.82" (7.6 - 20.8) Sm: 0.27" - 0.53" (6.9 - 13.5) Lg: 0.38" - 0.70" (9.5 - 17.8)
6-port Multi-Drop Grommet in. (mm)	0.20" - 0.37" (5.1 - 9.4)
Dimensions – (L x D) in. (mm)	36.0" x 8.0" x 4.0" (914.0 x 203.0 x 102.0)
Weight – lbs. (kg)	8.5 (3.81)

continued
→

LightGuard® 420 Aerial Weathertight Fiber Optic Splice Closure

Ordering Information

DESCRIPTION	MODEL NO.	AFL NO.
LG-420 Aerial Weathertight Fiber Optic Splice Closure – Stores 12 single fusion or 48 mass fusion, includes (4) cable kits for sealing/retention and (2) ground terminals with removable bond, splice chips and hanger brackets. Not included: Cable Grounding Kits	LG-420-U-0	FC000023
Small Single Grommet Kit (10 pc grommet only) (Min 0.38" - Max 0.82")	Small Single Grommet Kit (10)	911496-00-00
Small Dual Grommet Kit – Includes: (2) small dual grommets and hardware (Min 0.27" - Max 0.53" and Min 0.38 - Max 0.70")	Small Dual Grommet Kit	911386-00-01
Small Dual Grommet Kit (10 pc grommet only) (Min 0.27" - Max 0.53" and Min 0.38 - Max 0.70")	Small Dual Grommet Kit (10)	911495-00-00
Small 6-Port Drop Cable Kit – 2 grommets with tie wrap and foam. Allows six cable entries (Min 0.20" - Max 0.365" and flat drop)	Small 6 Port Drop Kit	FC000644
Adjustable Aerial Hanger Kit Bracket Kit (included with closure)	Adjustable Hanger LG-400/500/600	911497-00-00
Extended Offset Aerial Hanger Kit LG-400/500/600	Offset Hanger LG-400/500/600	91990-00
Retention hardware for additional cables or replacement hardware – LG-400/500/600 (no grommets)	Cable Retention Kit LG-400/500/600	FC000356
Closure Extension Kit – Used to join multiple closures for extended sheath openings required to repair cable sheath and damaged fibers	Closure Extension Kit LG-400/500/600	911499-00-00
1x6 Fiber Router Kit with furcation tubes	1x6 Fiber Router	FC000070
Cable Grounding Kit (pack of 5) – Clamp-On Ground Cable Only	CGK-5	FC001091
*Mechanical Splice Kit. Includes 10 pieces of VHB tape. Used in all splice trays. Each piece holds 12 splices.	VHB Tape	FA000089

* See Accessory Specifications. See Splice Tray Specifications.

Qualifications

GOVERNING BODY	STANDARD CODE
Telcordia	GR-771
Rural Utilities Service (RUS)	Listed

Contact AFL for further details.



LightGuard® 420 FTTx Aerial Weathertight Fiber Optic Splice Closure

The LightGuard (LG) 420 FTTx Aerial Weathertight Fiber Optic Splice Closure is designed for taut sheath (no slack) splicing (up to 32 single) in an in-line configuration. Utilized in aerial applications, the LG-420-FTTx is ideal for FTTx access networks by providing access for up to 12 drop cables and 16 connections, requiring only a common can wrench for installation.

Features

- Four individual, self-sizing grommeted cable ports:
 - 2 express ports
 - 2 multi-drop ports
- 12 drop cables and 16 connections
- Special multi-drop grommet and cable retention
- Special lock-out interior enclosure
- Patented tongue-in-groove cover seal system
- Installation and re-entry only require a common can wrench
- Cable retention clamps provide pullout
- UV resistant engineered thermoplastic

Specifications

PARAMETER	VALUE
Splice Capacity (Max.) – Single, Mass, Mechanical	32, n/a, 12
Number of Splice Trays (Max.) – Single, Mass, Mechanical*	1, n/a, 1
Cable Entrance Configuration	In-line (taut sheath)
Cables	2 to 4 Express with up to 12 Drop
Cable Sizes (Min. O.D. - Max. O.D.) Included Grommets	(4) Cable Ports
Single in. (mm)	2 @ 0.38" - 0.82" (7.6 - 20.8)
6-port Multi-Drop Grommet in. (mm)	2 (6 port) @ 0.20" - 0.37" (5.1 - 9.4)
Additional Grommets	
Dual Grommet in. (mm)	Sm: 0.27" - 0.53" (6.9 - 13.5)
	Lg: 0.38" - 0.70" (9.5 - 17.8)
6-port Multi-Drop Grommet in. (mm)	0.20" - 0.37" (5.1 - 9.4)
Dimensions – (L x D) in. (mm)	36.0" x 8.0" x 4.0" (914.0 x 203.0 x 102.0)
Weight – lbs. (kg)	8.5 (3.81)

continued
→

LightGuard® 420 FTTx Aerial Weathertight Fiber Optic Splice Closure

Ordering Information

DESCRIPTION	MODEL NO.	AFL NO.
The AFL LightGuard (LG) 420 FTTx Aerial Weathertight Fiber Optic Splice Closures are designed to allow taut sheath (no slack) or conventional splicing in aerial applications such as FTTx access networks. The LG-420 FTTx provides access for 1 to 16 connections and up to 12 subscriber drops and requires only a common can wrench for installation. Includes: Hanger Brackets and Splice Tray. Not included: Cable Grounding Kits.	LG-420-U-FTTx	FC000099
LL-2425 Single Splice Tray – Stores (32) single fusion splices. Maximum of 1 tray in the LG-420-FTTx.	LL-2425	FC000053
Small Single Grommet Kit of (10 pc grommet only) – (Min .38" - Max .82")	Small Single Grommet Kit (10)	911496-00-00
Small Dual Grommet Kit – Includes: (2) small dual grommets and hardware (Min .27" - Max .53" and Min .38" - Max .70")	Small Dual Grommet Kit	911386-00-01
Small Dual Grommet Kit (10 pc grommet only) – (Min .27" - Max .53" and Min .38" - Max .70")	Small Dual Grommet Kit (10)	911495-00-00
Small 6-Port Drop Cable Kit – 2 grommets with tie wrap and foam. Allows six cable entries (Min 0.20" - Max 0.365" and flat drop)	Small 6 Port Drop Kit	FC000644
Adjustable Aerial Hanger Kit Bracket Kit (included with closure)	Adjustable Hanger LG-400/500/600	911497-00-00
Extended Offset Aerial Hanger Kit LG-400/500/600	Offset Hanger LG-400/500/600	91990-00
Retention hardware for additional cables or replacement hardware – LG-400/500/600 (no grommets)	Cable Retention Kit LG-400/500/600	FC000356
Closure Extension Kit – Used to join multiple closures for extended sheath openings required to repair cable sheath and damaged fibers	Closure Extension Kit LG-400/500/600	911499-00-00
1x6 Fiber Router Kit with furcation tubes.	1x6 Fiber Router	FC000070
Cable Grounding Kit (pack of 5) – Clamp-On Ground Cable Only	CGK-5	FC001091
*Mechanical Splice Kit. Includes 10 pieces of VHB tape. Used in all splice trays. Each piece holds 12 splices.	VHB Tape	FA000089

* See Accessory Specifications. See Splice Tray Specifications.

Qualifications

GOVERNING BODY	STANDARD CODE
Telcordia	GR-771
Rural Utilities Service (RUS)	Listed

Contact AFL for further details.

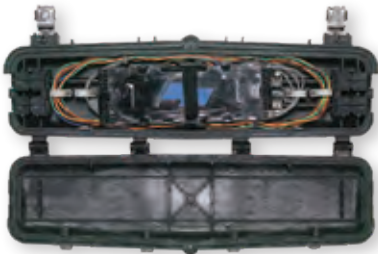

LightGuard® 500 Aerial Weathertight Fiber Optic Splice Closure

The LightGuard (LG) 500 Aerial Weathertight Fiber Optic Splice Closure is designed for medium count fiber splicing (up to 144 single or 432 mass) in a butt or in-line configuration. Utilized in aerial applications, the LG-500 is ideal for congested aerial construction due to its compact design and requires only a common can wrench for installation.

Features

- Four individual, self-sizing grommeted cable ports (expandable up to eight cable entrances)
- Patented tongue-in-groove cover seal system
- Installation and re-entry only require a common can wrench
- Cable retention clamps provide pullout
- UV resistant engineered thermoplastic

Specifications

PARAMETER	VALUE
Splice Capacity (Max.) – Single, Mass, Mechanical	144, 432, 36
Number of Splice Trays (Max.) – Single, Mass, Mechanical*	4, 3, 4
Cable Entrance Configuration	Butt or in-line
Cables	4 to 8
Cable Sizes (Min. O.D. - Max. O.D.) Included Grommets Single in. (mm) Additional Grommets Dual Grommet in. (mm)	(4) Cable Ports 4 @ 0.38" - 0.82" (7.6 - 20.8) Sm: 0.27" - 0.53" (6.9 - 13.5) Lg: 0.38" - 0.70" (9.5 - 17.8)
6-port Multi-Drop Grommet in. (mm)	0.20" - 0.37" (5.1 - 9.4)
Dimensions – (L x D) in. (mm)	27.0" x 8.3" x 4.0" (686.0 x 210.0 x 102.0)
Weight – lbs. (kg)	6.4 (2.90)

continued
→

LightGuard® 500 Aerial Weathertight Fiber Optic Splice Closure

Ordering Information

DESCRIPTION	MODEL NO.	AFL NO.
LG-500 Aerial Weathertight Fiber Optic Splice Closure – Stores 144 single fusion or 432 mass fusion, includes (4) cable kits for sealing/retention and (2) ground terminals with removable bond, and hanger brackets. Not included: Splice Trays or Cable Grounding Kits	LG-500-U-0	FC000026
LL-2400 Single Splice Tray – Stores (24) single fusion splices. Maximum of 4 trays in the LG-500.	LL-2400	91710-06
LL-2448 Universal Splice Tray – Stores (24) single fusion or (4) mass fusion splices (48 F) , *Mechanical. Maximum of 3 trays in the LG-500.	LL-2448	911289-00-02
LL-4848 Mass Splice Tray – Stores (12) mass fusion splices (144 F). Maximum of 3 trays in the LG-500.	LL-4848	911437-00-02
LL-2448-48S Single Splice Tray – Stores (48) single fusion splices. Maximum of 3 trays in the LG-500.	LL-2448-48S	FA000045
Small Single Grommet Kit (10 pc grommet only) – (Min 0.38" - Max 0.82")	Small Single Grommet Kit (10)	911496-00-00
Small Dual Grommet Kit – Includes: (2) small dual grommets and hardware (Min 0.27" - Max 0.53" and Min 0.38" - Max 0.70")	Small Dual Grommet Kit	911386-00-01
Small 6-Port Drop Cable Kit – 2 grommets with tie wrap and foam. Allows six cable entries. (Min 0.20" - Max 0.365" and flat drop)	Small 6 Port Drop Kit	FC000573
Adjustable Aerial Hanger Kit Bracket Kit (included with closure)	Adjustable Hanger LG-400/500/600	911497-00-00
Extended Offset Aerial Hanger Kit for LG-400/500/600	Offset Hanger LG-400/500/600	91990-00
Retention hardware for additional cables or replacement hardware – LG-400/500/600 (no grommets)	Cable Retention Kit LG 400/500/600	FC000356
Closure Extension Kit – Used to join multiple closures for extended sheath openings required to repair cable sheath and damaged fibers	Closure Extension Kit LG-400/500/600	911499-00-00
1x6 Fiber Router Kit with furcation tubes.	1x6 Fiber Router	FC000070
Cable Grounding Kit (pack of 5) – Clamp -On Ground Cable Only	CGK-5	FC001091
*Mechanical Splice Kit. Includes 10 pieces of VHB tape. Used in all splice trays. Each piece holds 12 splices.	VHB Tape	FA000089

* See Accessory Specifications. See Splice Tray Specifications.

Qualifications

GOVERNING BODY	STANDARD CODE
Telcordia	GR-771
Rural Utilities Service (RUS)	Listed

Contact AFL for further details.



LightGuard® 500 FTTx Aerial Weathertight Fiber Optic Splice Closures

The LightGuard (LG) 500 FTTx Aerial Weathertight Fiber Optic Splice Closure is designed for small count fiber splicing (up to 32 single or 48 mass) in a butt or in-line configuration. Utilized in aerial applications, the LG-500-FTTx is ideal for FTTx access networks by providing cable entry and connectivity for up to 12 drop cables and 16 connections, requiring only a common can wrench for installation.

Features

- Four individual, self-sizing grommets cable ports:
 - 2 express ports
 - 2 multi-drop ports
- 12 drop cables and 16 connections
- Special multi-drop grommet and cable retention
- Special lock-out interior enclosure
- Patented tongue-in-groove cover seal system
- Installation and re-entry only require a common can wrench
- Cable retention clamps provide pullout
- UV resistant engineered thermoplastic

Specifications

PARAMETER	VALUE
Splice Capacity (Max.) – Single, Mass, Mechanical	32, 48, 12
Number of Splice Trays (Max.) – Single, Mass, Mechanical*	1, 1, 1
Cable Entrance Configuration	Butt or in-line
Cables	2 to 4 Express with up to 12 Drop
Cable Sizes (Min. O.D. - Max. O.D.) Included Grommets	(4) Cable Ports
Single in. (mm)	4 @ 0.38" - 0.82" (7.6 - 20.8)
6-port Multi-Drop Grommet in. (mm)	2 (6 port) @ 0.20" - 0.37" (5.1 - 9.4)
Additional Grommets	
Dual Grommet in. (mm)	Sm: 0.27" - 0.53" (6.9 - 13.5)
	Lg: 0.38" - 0.70" (9.5 - 17.8)
6-port Multi-Drop Grommet in. (mm)	0.20" - 0.37" (5.1 - 9.4)
Dimensions – (L x D) in. (mm)	27.0" x 8.3" x 4.0" (686.0 x 210.0 x 100.0)
Weight – lbs. (kg)	10.1 (4.58)

continued
→

LightGuard® 500 FTTx Aerial Weathertight Fiber Optic Splice Closure

Ordering Information

DESCRIPTION	MODEL NO.	AFL NO.
LG-500-FTTx Aerial Weathertight Fiber Optic Splice Closure – Stores 32 single fusion or 48 mass fusion, includes (4) cable kits for sealing/retention and (2) ground terminals with removable bond, (1) splice tray, and hanger brackets. Not included: Cable Grounding Kits, SCAPC Adapters	LG-500-FTTx	FC000899
LL-2425 Single Splice Tray – Stores (32) single fusion splices. Maximum of 1 tray in the LG-500-FTTx.	LL-2425	FC000053
Small Single Grommet Kit of (10 pc grommet only) – (Min 0.38" - Max 0.82")	Small Single Grommet Kit (10)	911496-00-00
Small Dual Grommet Kit – Includes: (2) small dual grommets and hardware (Min 0.27" - Max 0.53" and Min 0.38" - Max 0.70")	Small Dual Grommet Kit	911386-00-01
Small Dual Grommet Kit (10 pc grommet only) – (Min 0.27" - Max 0.53" and Min 0.38" - Max 0.70")	Small Dual Grommet Kit (10)	911495-00-00
Small 6-Port Drop Cable Kit – 2 grommets with tie wrap and foam tape. Allows six cable entries. (Min 0.20" - Max 0.37" and flat drop)	Small 6 Port Drop Kit	FC000573
Adjustable Aerial Hanger Kit Bracket Kit (included with closure)	Adjustable Hanger LG-400/500/600	911497-00-00
Extended Offset Aerial Hanger Kit LG-400/500/600	Offset Hanger LG-400/500/600	91990-00
Retention hardware for additional cables or replacement hardware – LG-400/500/600 (no grommets)	Cable Retention Kit LG-400/500/600	FC000356
Closure Extension Kit – Used to join multiple closures for extended sheath openings required to repair cable sheath and damaged fibers	Closure Extension Kit LG-400/500/600	911499-00-00
1x6 Fiber Router Kit with furcation tubes	1x6 Fiber Router	FC000070
Cable Grounding Kit (pack of 5) – Clamp -On Ground Cable Only	CGK-5	FC001091
Mechanical Splice Kit*. Includes 10 pieces of VHB tape. Used in all splice trays. Each piece holds 12 splices.	VHB Tape	FA000089
Single-mode SC Simplex Adapter, Flangeless, Green	SC/APC Adapter	CS009394
SC/APC 900 μm Pigtail, 1.5 Meter Length	ASC, XXX, JH, 001, Q, 001.5, White	CS012973C-001.5

* See Accessory Specifications. See Splice Tray Specifications.

Qualifications

GOVERNING BODY	STANDARD CODE
Telcordia	GR-771
Rural Utilities Service (RUS)	Listed

Contact AFL for further details.



LightGuard® 600 Aerial Weathertight Fiber Optic Splice Closure

The LightGuard (LG) 600 Aerial Weathertight Fiber Optic Splice Closure is designed for high count fiber splicing (up to 384 single or 1152 mass) in a butt or in-line configuration. Utilized in aerial applications, the LG-600 is an ideal cost-effective solution for high fiber count splicing and requires only a common can wrench for installation.

Features

- Six individual, self-sizing grommeted cable ports (expandable to 12 cable entrances)
- Patented tongue-in-groove cover seal system
- Installation and re-entry only require a common can wrench
- Integrated grounding clamp through aerial hangers
- Cable retention clamps provide pullout
- UV resistant engineered thermoplastic

Specifications

PARAMETER	VALUE
Splice Capacity (Max.) – Single, Mass, Mechanical	384, 1152, 36
Number of Splice Trays (Max.) – Single, Mass, Mechanical*	12, 8, 8
Cable Entrance Configuration	Butt or in-line
Cables	6 to 24
Cable Sizes (Min. O.D. - Max. O.D.) Included Grommets Single in. (mm)	(6) Cable Ports 0.44" - 1.00" (11.2 - 25.4)
Additional Grommets Dual Grommet in. (mm)	Sm: 0.40" - 0.70" (10.0 - 17.8) Lg: 0.60" - 0.90" (15.3 - 22.9)
6-port Multi-Drop Grommet in. (mm)	0.30" - 0.48" (7.6 - 17.8)
Dimensions – (L x D) in. (mm)	27.0" x 11.3" x 7.5" (690.0 x 286.0 x 190.5)
Weight – lbs. (kg)	18.0 (8.16)

continued
→

LightGuard® 600 Aerial Weathertight Fiber Optic Splice Closure

Ordering Information

DESCRIPTION	MODEL NO.	AFL NO.
LG-600 Aerial Weathertight Fiber Optic Splice Closure – Stores 384 single fusion or 1152 mass fusion, includes (4) cable kits for sealing/retention and (2) ground terminals with removable bond and hanger brackets. Not included: Splice Trays or Cable Grounding Kits	LG-600-U-0	FC000029
LL-2400 Single Splice Tray – Stores (24) single fusion splices. Maximum of 12 trays in the LG-600.	LL-2400	91710-06
LL-2448 Universal Splice Tray – Stores (24) single fusion or (4) mass fusion splices (48 F). Maximum of 8 trays in the LG-600, *Mechanical	LL-2448	911289-00-02
LL-4848 Mass Splice Tray – Stores (12) mass fusion splices (144 F). Maximum of 8 trays in the LG-600.	LL-4848	911437-00-02
LL-2448-48S Single Splice Tray – Stores (48) single fusion splices. Maximum of 8 trays in the LG-600.	LL-2448-48S	FA000045
Large Single Grommet Kit with retention hardware (Min 0.44" - Max 1.00")	Large Single Grommet Kit	FC000623
Large Single Grommet Kit (10 pc grommet only) – (Min 0.44" - Max 1.00")	Large Single Grommet Kit (10)	91918-00
Large Dual Grommet Expansion Kit – Includes: (2) Dual grommets and hardware (Min 0.40" - Max 0.70" and Min 0.60" - Max 0.90")	Large Dual Grommet Kit	911406-00-00
Large 6 Port Drop Cable Kit – 2 Grommets with retention bracket. Allows six cable entries. (Min 0.23" - Max 0.48" and flat drop)	Large 6 Port Drop Kit	FC000352
Adjustable Aerial Hanger Kit Bracket Kit (included with closure)	Adjustable Hanger LG-400/500/600	911497-00-00
Extended Offset Aerial Hanger Kit LG-400/500/600	Offset Hanger LG-400/500/600	91990-00
SC 6-pack bracket kit for LG-600	Bracket Kit (6-pack SC) LG-600	FM001294
Retention hardware for additional cables or replacement hardware – LG-400/500/600 (no grommets)	Cable Retention Kit LG-400/500/600	FC000356
Closure Extension Kit – Used to join multiple closures for extended sheath openings required to repair cable sheath and damaged fibers	Closure Extension Kit LG-400/500/600	911499-00-00
1x6 Fiber Router Kit with furcation tubes	1x6 Fiber Router	FC000070
Cable Grounding Kit (pack of 5) – Clamp -On Ground Cable Only	CGK-5	FC001091
*Mechanical Splice Kit. Includes 10 pieces of VHB tape. Used in all splice trays. Each piece holds 12 splices.	VHB Tape	FA000089

* See Accessory Specifications. See Splice Tray Specifications.

Qualifications

GOVERNING BODY	STANDARD CODE
Telcordia	GR-771
Rural Utilities Service (RUS)	Listed

Contact AFL for further details.

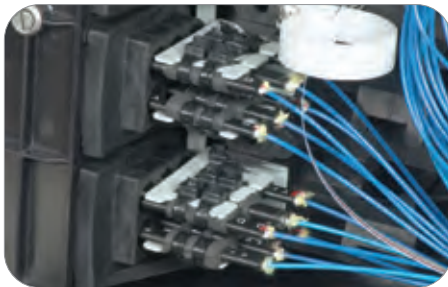

Cable entrance



Grommet bracket

LightGuard® 600 FTTx Aerial Weathertight Fiber Optic Splice Closure

The LightGuard (LG) 600 FTTx Aerial Weathertight Fiber Optic Splice Closure is designed for small count fiber splicing (up to 48 single or 48 mass) in a butt or in-line configuration. Utilized in aerial applications, the LG-600-FTTx is ideal for express slack look fiber access splicing by providing cable entry and connectivity for up to 24 subscriber drops and requires only a common can wrench for installation.

Features

- Six individual, self-sizing grommets cable ports:
 - 2 express ports
 - 4 multi-drop ports
- Up to 12 adapters using the LG-600 expansion kit and SC 6-pack adapter brackets
- Special multi-drop grommets and cable retention
- Integrated aerial splicing work tray
- Patented tongue-in-groove cover seal system
- Installation and re-entry only require a common can wrench
- Integrated grounding clamp through aerial hangers
- Cable retention clamps provide pullout
- UV resistant engineered thermoplastic

Specifications

PARAMETER	VALUE
Splice Capacity (Max.) – Single, Mass, Mechanical	24, 48, 24
Number of Splice Trays (Max.) – Single, Mass, Mechanical*	2, 2, 2
Cable Entrance Configuration	Butt or in-line
Cables	2 to 4 Express with up to 24 Drops
Cable Sizes (Min. O.D. - Max. O.D.) Included Grommets	(6) Cable Ports 2 @ 0.44" - 1.00" (11.2 - 25.4) 4 @ 0.30" - 0.48" (7.6 - 17.8)
Single in. (mm)	
6-port Multi-Drop Grommet in. (mm)	
Additional Grommets	
Dual Grommet in. (mm)	Sm: 0.40" - 0.70" (10.0 - 17.8) Lg: 0.60" - 0.90" (15.3 - 22.9)
Dimensions – (L x D) in. (mm)	27.00" x 11.25" x 7.50" (690.0 x 286.0 x 190.5)
Weight – lbs. (kg)	18.0 (8.16)

continued
→

LightGuard® 600 FTTx Aerial Weathertight Fiber Optic Splice Closure

Ordering Information

DESCRIPTION	MODEL NO.	AFL NO.
LG-600-FTTx Aerial Weathertight Fiber Optic Splice Closure – Stores 24 single fusion or 48 mass fusion, includes (6) cable kits for sealing/retention and (2) ground terminals with removable bond, (2) splice tray, and hanger brackets. Not included: Cable Grounding Kits	LG600-FTTx	FC000291
LL-2450 Single Splice Tray – Stores (12) single fusion splices. Maximum of (2) trays in the LG-600-FTTx.	LL-2450	91957-00
LL-4850 Mass Splice Tray – Stores (8) mass fusion splices (96F). Maximum of (2) trays in the LG-600-FTTx.	LL-4850	91958-00
LL-1248 Universal Splice Tray – Stores (12) single fusion splices or (8) mass fusion splices (96F), *Mechanical. Maximum of 2 trays in the LG-600FTTx.	LL-1248	911221-00-00
Large Single Grommet Kit with retention hardware (Min 0.44" - Max 1.00")	Large Single Grommet Kit	FC000623
Large Single Grommet Kit (10 pc grommet only) – (Min 0.44" - Max 1.00")	Large Single Grommet Kit (10)	91918-00
Adjustable Aerial Hanger Kit Bracket Kit (included with closure)	Adjustable Hanger LG-400/500/600	911497-00-00
Extended Offset Aerial Hanger Kit – LG-400/500/600	Offset Hanger LG-400/500/600	91990-00
Retention hardware for additional cables or replacement hardware – LG/400/500/600 (no grommets)	Cable Retention Kit LG-400/500/600	FC000356
Closure Extension Kit – Used to join multiple closures for extended sheath openings required to repair cable sheath and damaged fibers	Closure Extension Kit LG-400/500/600	911499-00-00
1x6 Fiber Router Kit with furcation tubes	1x6 Fiber Router	FC000070
Cable Grounding Kit (pack of 5) – Clamp-On Ground Cable Only	CGK-5	FC001091
*Mechanical Splice Kit. Includes 10 pieces of VHB tape. Used in all splice trays. Each piece holds 12 splices.	VHB Tape	FA000089
LG-600 FTTx Expansion Kit – Includes (1) Stacker Module, (1) SC-6-Pack Bracket. Allows use of standard splice trays.	LG-600 FTTx Expansion Kit	FC000620

* See Accessory Specifications. See Splice Tray Specifications.

Qualifications

GOVERNING BODY	STANDARD CODE
Telcordia	GR-771
Rural Utilities Service (RUS)	Listed

Contact AFL for further details.

LightGuard® Aerial Splice Closure Accessories



Dual-port Grommet Kit



Multi-port Grommet Kit

Dual- and Multi-port Grommet Kits for LG-400/LG-500/LG-600

For use with the LG-600 Aerial Weathertight Closure. Remove the single-port grommet set from the closure and replace with the multi-port grommet set when drops are required. Retention hardware included.

Ordering Information

DESCRIPTION	AFL NO.
Dual-port Grommet Kit for LG-400/LG-500 Diameter for large port is 0.375" - 0.65"; small port, 0.27" - 0.5"	911386-00-01
Dual Grommet Expansion Kit - Includes: (2) Dual Grommets, (1) CSM retention clamp, cable retention clamp and cable spacer	911406-00-00
Dual Grommet Replacement Kit - Includes: (10) Dual Grommets for the LG-400 Series Closures. Diameter for large port is 0.375" - 0.65"; small port, 0.27" - 0.5"	911495-00-00
Grommet Replacement Kit, Kit - Includes: (10) Standard (single port) Grommets for the LG-400 Series Closures. Diameter from 0.3" - 0.82"	911496-00-00
Grommet Replacement Kit - Includes: (10) LG-600 Grommets Diameter from 0.5" - 1.0"	91918-00
Multi-port Grommet Kit for LG-400/LG-500. Diameter up to 0.365"	FC000573
Multi-port Grommet Kit for LG-600. Diameter from 0.67" to 0.475"	FC000352



Single-port Grommet Kit for LG-600 FTTx

For use with the LG-600 Aerial Weathertight Closure. Remove the multi-port grommet set from the closure and replace with the single-port grommet set when installing a branch cable. Hardware included.

Ordering Information

DESCRIPTION	AFL NO.
Single-port Grommet Kit for LG-600 FTTx	FC000623
Single Cable Entry Grommet Kit LG-600 Hardware	FC000356



Adjustable Aerial Hanger Brackets

For use with all Aerial Weathertight Closures (LG-410, LG-420, LG-420 FTTx, LG-500, LG-600 and LG-600 FTTx). This pair of hanger brackets is shipped from the factory with all weathertight closures. Purchase separately for closures installed over existing utilities.

Ordering Information

DESCRIPTION	AFL NO.
Adjustable Aerial Hanger Brackets	911497-00-00

continued
→

LightGuard® Aerial Splice Closure Accessories (cont.)

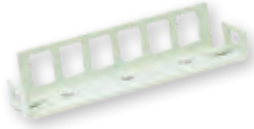

SC 6-Pack Bracket for LG-600

Installs at each end of the stacker module in the LG-600. Allows up to (12) SC connectors or (24) LC connectors (using duplex connectors) to be installed in the closure. Snaps in place or use self-tapping screws to secure.

Ordering Information

DESCRIPTION	AFL NO.
SC 6-Pack Bracket Kit for LG-600	FM001294
SC 6-Pack Adapter Bracket	FM001212



Expansion Kit for LG-600 FTTx

Expansion kit includes a Stacker Tray Module and one LG-600 SC-6-Pack Bracket to allow for up to six SC connections or 12 LC duplex connections. An additional bracket may be used to increase connectivity to 12 SC or 24 LC connections using duplex adapters. Allows increasing splices with LL-2400, LL-2448 and LL-2448-48S splice trays.

Ordering Information

DESCRIPTION	AFL NO.
Expansion Kit for LG-600 FTTx	FC000620



Cable Grounding Harness

For use with all Aerial Weathertight Closures (LG-410, LG-420, LG-420 FTTx, LG-500, LG-600 and LG-600 FTTx).

Ordering Information

DESCRIPTION	AFL NO.
Cable Grounding Harness - Includes: (4) Harness 8" #6 AWG	FC000024



Aerial Hanger Kits

For use with all Aerial Weathertight Closures (LG-410, LG-420, LG-420 FTTx, LG-500, LG-600 and LG-600 FTTx).

Ordering Information

DESCRIPTION	AFL NO.
Extended Aerial Hanger Kit	911497-00-00
Extended Offset Aerial Hanger Kit	91990-00

Interchangeable Grommets for Fiber Optic Splice Closures and Fiber Enclosures

Splice Closures & Accessories

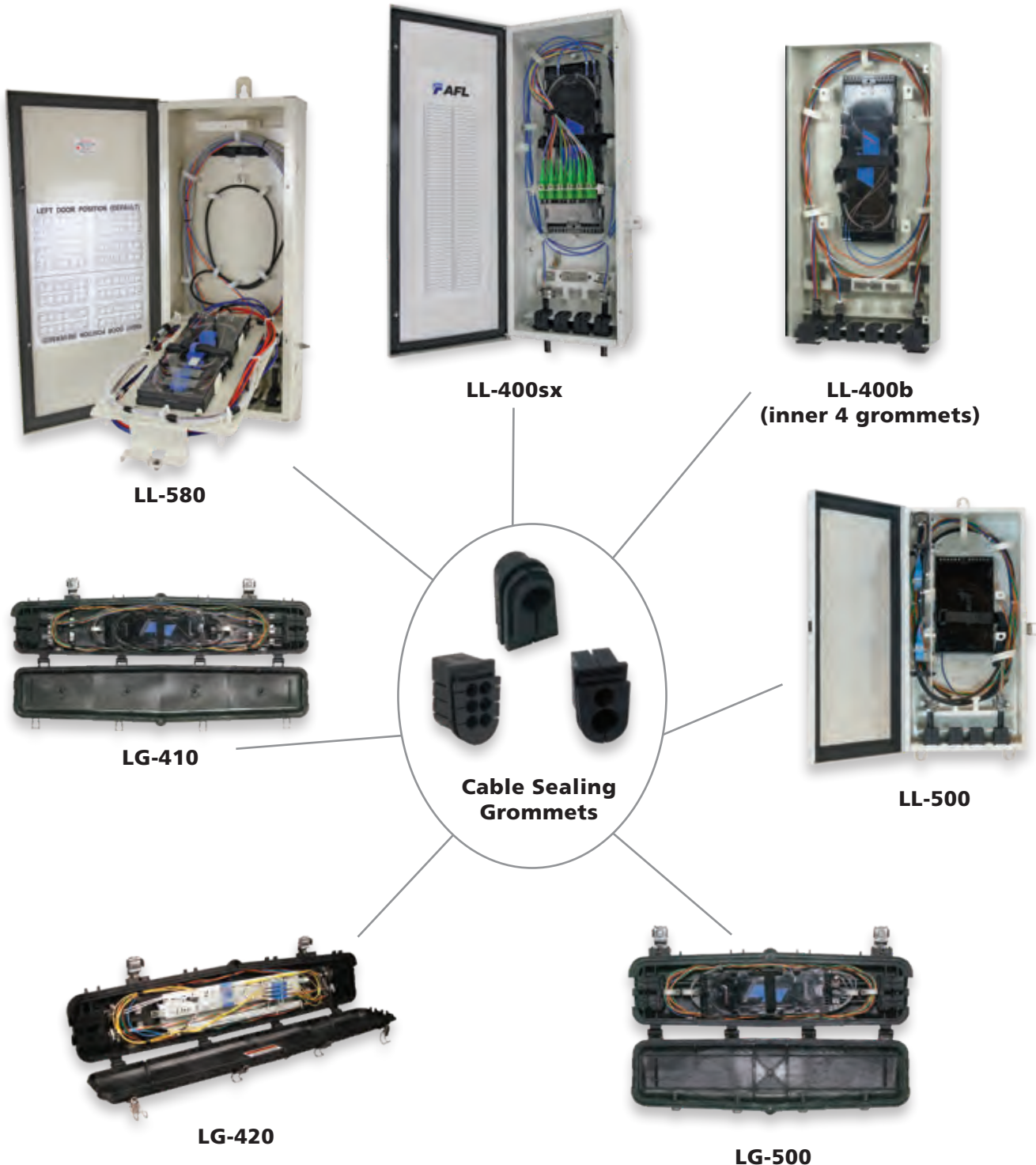

continued
→

Interchangeable Large Grommets for Fiber Optic Splice Closures and Fiber Enclosures



LL-400b
(outer 2 grommets)



LG-600



LightLink Fiber Optic Splice Trays

AFL's LightLink series of Fiber Optic Splice Trays offers a variety of unique and flexible splice and storage possibilities. They are available in industry standard configurations (single, mass).

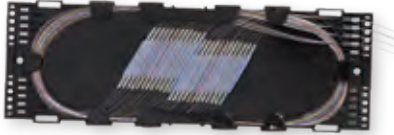

Features

- In-line or butt splice capability (see model descriptions)
- Pre-formed radiuses maintain bend requirements
- Interlocking base and cover provides tray stability without the use of a bolt
- Extended finger guides easily store and route loose fiber or ribbon

Ordering Information—Splice Trays for Sealed Fiber Optic Splice Closures

DESCRIPTION	MODEL NO.	AFL NO.	LG-55-U	LG-150-U	LG-250-U	LG-350-U	LG-350-20-WTC	LG-350-27-WTC
Single Fuse: 32 Mass Fuse: N/A 6.300" (L) x 2.730" (W) x 0.829" (H) 	LL-2425	FC000053	Max trays: 1 Single: 32 Mass: N/A	N/A	N/A	N/A	N/A	N/A
Single Fuse: 12 Mass Fuse: N/A 7.139" (L) x 4.294" (W) x 0.370" (H) 	LL-2450	91957-00	N/A	Max Trays: 4 Single: 48 Mass: N/A	N/A	N/A	N/A	N/A
Single Fuse: N/A Mass Fuse: 8 (96 fiber) 7.139" (L) x 4.294" (W) x 0.370" (H) 	LL-4850	91958-00	N/A	Max Trays: 4 Single: N/A Mass: 32 (384 fiber)	N/A	N/A	N/A	N/A
Single Fuse: 12 Mass Fuse: 8 (96 fiber) 7.139" (L) x 4.294" (W) x 0.370" (H) 	LL-1248	911221-00-00	N/A	Max Trays: 4 Single: 48 Mass: 48 (384 fiber)	N/A	N/A	N/A	N/A
Single Fuse: 24 Mass Fuse: N/A 12.542" (L) x 4.042" (W) x 0.390" (H) 	LL-2400	91710-06	N/A	N/A	Max Trays: 5 Single: 120 Mass: N/A	Max Trays: 13 Single: 312 Mass: N/A	N/A	N/A

continued
→

LightLink Fiber Optic Splice Trays (cont.)

Ordering Information—Splice Trays for Sealed Fiber Optic Splice Closures

DESCRIPTION	MODEL NO.	AFL NO.	LG-250-U	LG-350-U	LG-350-AC	LG-350XL-U	LG-350-20-WTC	LG-350-27-WTC
Single Fuse: 60 Mass Fuse: 12 (144 fiber) 12.000" (L) x 5.125" (W) x 0.485" (H)  *Note: Contains enough splice holders for 24 mass splices (288 fibers) when using AFL Wrapping Tube Cable.	LL-7644	FA000044	N/A	Max Trays: 6 Single: 360 Mass: 72 (864 fiber)	N/A	N/A	N/A	Max Trays: 3 Single: 180 Mass: 72 (864 fiber)
Single Fuse: 24 Mass Fuse: 4 (48 fiber) 12.542" (L) x 4.270" (W) x 0.531" (H) 	LL-2448	911289-00-02	Max Trays: 3 Single: 72 Mass: 12 (144 fiber) Mechanical: 36	Max Trays: 8 Single: 192 Mass: 32 (384 fiber) Mechanical: 96	N/A	N/A	N/A	N/A
Single Fuse: 48 Mass Fuse: N/A 12.542" (L) x 4.270" (W) x 0.531" (H) 	LL-2448-48S	FA000045	Max Trays: 3 Single: 144 Mass: N/A	Max Trays: 8 Single: 384 Mass: N/A	N/A	N/A	N/A	N/A
Single Fuse: N/A Mass Fuse: 12 (144 fiber) 12.542" (L) x 4.270" (W) x 0.531" (H) 	LL-4848	911437-00-02	Max Trays: 3 Single: N/A Mass: 36 (432 fiber)	Max Trays: 8 Single: N/A Mass: 96 (1152 fiber)	N/A	N/A	N/A	N/A
Single Fuse: 96 Mass Fuse: 24 (288 fiber) 15.950" (L) x 4.875" (W) x 0.485" (H) 	LL-4896	911676-00-02	N/A	Max Trays: 5 Single: 480 Mass: 120 (1440 fiber)	N/A	Max Trays: 9 Single: 864 Mass: 216 (2592 fiber)	N/A	N/A
Single Fuse: 60 Mass Fuse: N/A 12.000" (L) x 5.125" (W) x 0.485" (H) 	LL-7060	FA000042	N/A	Max Trays: 6 Single: 360 Mass: N/A	N/A	N/A	N/A	Max Trays: 3 Single: 180 Mass: N/A

continued
→

LightLink Fiber Optic Splice Trays (cont.)

Ordering Information – Splice Trays for LG-350 and LG-350XL-U Sealed Fiber Optic Splice Closures

DESCRIPTION	MODEL NO.	AFL NO.	LG-350-U	LG-350-AC	LG-350XL-U	LG-350-20-WTC	LG-350-27-WTC
Single Fuse: N/A Mass Fuse: 12 (144 fiber) 12.000" (L) x 5.125" (W) x 0.485" (H) 	LL-7144	FA000043	Max Trays: 6 Single: 360 Mass: 72 (864 fiber)	N/A	N/A	N/A	Max Trays: 3 Single: 180 Mass: 72 (864 fiber)
Single Fuse: 36 Mass Fuse: 12 (144 fiber) 8.125" (L) x 4.875" (W) x 0.485" (H) 	LL-4808L-R	FA000037	N/A	Max Trays: 4 Single: 144 Mass: 48 (576 fiber)	N/A	Max Trays: 4 Single: 144 Mass: 48 (576 fiber)	N/A
Single Fuse: N/A Mass Fuse: 12 (144 fiber) 8.125" (L) x 4.875" (W) x 0.485" (H) 	LL-4808 R	FA000020	N/A	Max Trays: 4 Single: N/A Mass: 48 (576 fiber)	N/A	Max Trays: 4 Single: N/A Mass: 48 (576 fiber)	N/A
Single Fuse: 36 Mass Fuse: N/A 8.125" (L) x 4.875" (W) x 0.485" (H) 	LL-4808 L	FA000021	N/A	Max Trays: 4 Single: 144 Mass: N/A	N/A	Max Trays: 4 Single: 144 Mass: N/A	N/A
Single Fuse: N/A Mass Fuse: 24 (288 fiber) 15.950" (L) x 4.875" (W) x 0.485" (H) 	LL-4896 R	FA000022	Max Trays: 5 Single: N/A Mass: 120 (1440 fiber)	N/A	Max Trays: 9 Single: N/A Mass: 216 (2592 fiber)	N/A	N/A
Single Fuse: 96 Mass Fuse: N/A 15.950" (L) x 4.875" (W) x 0.485" (H) 	LL-4896 L	FA000023	Max Trays: 5 Single: 480 Mass: N/A	N/A	Max Trays: 9 Single: 864 Mass: N/A	N/A	Max Trays: 3 Single: 180 Mass: N/A

continued
→

Splice Trays

LightLink Fiber Optic Splice Trays (cont.)

Ordering Information – Splice Trays for Aerial Weathertight Fiber Optic Splice Closures

DESCRIPTION	MODEL NO.	AFL NO.	LG-410-U	LG-420-U FTTx	LG-500-U	LG-500-U FTTx
Single Fuse: 24 Mass Fuse: N/A 12.542" (L) x 4.042" (W) x 0.390" (H) 	LL-2400	91710-06	Max Trays: 4 Single: 96 Mass: N/A	N/A	Max Trays: 4 Single: 96 Mass: N/A	N/A
Single Fuse: 32 Mass Fuse: N/A 6.300" (L) x 2.730" (W) x 0.829" (H) 	LL-2425	FC000053	N/A	Max Trays: 1 Single: 32 Mass: N/A	N/A	Max Trays: 1 Single: 32 Mass: N/A
Single Fuse: 24 Mass Fuse: 4 (48 fiber) 12.542" (L) x 4.270" (W) x 0.531" (H) 	LL-2448	911289-00-02	Max Trays: 3 Single: 72 Mass: 12 (144 fiber) Mechanical: 36	N/A	Max Trays: 3 Single: 72 Mass: 12 (144 fiber) Mechanical: 36	N/A
Single Fuse: 12 Mass Fuse: N/A 7.139" (L) x 4.294" (W) x 0.370" (H) 	LL-2450	91957-00	N/A	N/A	N/A	N/A
Single Fuse: N/A Mass Fuse: 12 (144 fiber) 12.542" (L) x 4.270" (W) x 0.531" (H) 	LL-4848	911437-00-02	Max Trays: 3 Single: N/A Mass: 36 (432 fiber)	N/A	Max Trays: 3 Single: N/A Mass: 36 (432 fiber)	N/A
Single Fuse: N/A Mass Fuse: 8 (96 fiber) 7.139" (L) x 4.294" (W) x 0.370" (H) 	LL-4850	91958-00	N/A	N/A	N/A	N/A
Single Fuse: 12 Mass Fuse: 8 (96 fiber) 7.139" (L) x 4.294" (W) x 0.370" (H) 	LL-1248	911221-00-00	N/A	N/A	N/A	N/A

continued
→

LightLink Fiber Optic Splice Trays (cont.)

Ordering Information – Splice Trays for Aerial Weathertight Fiber Optic Splice Closures

DESCRIPTION	MODEL NO.	AFL NO.	LG-500-U-FTTx-ISO	LG-600-U	LG-600-FTTx	LG-600-U-FTTx-ISO
Single Fuse: 24 Mass Fuse: N/A 12.542" (L) x 4.042" (W) x 0.390" (H) 	LL-2400	91710-06	N/A	Max Trays: 12 Single: 288 Mass: N/A	Max Trays: 2 Single: 48 Mass: N/A	N/A
Single Fuse: 32 Mass Fuse: N/A 6.300" (L) x 2.730" (W) x 0.829" (H) 	LL-2425	FC000053	N/A	N/A	N/A	N/A
Single Fuse: 24 Mass Fuse: 4 (48 fiber) 12.542" (L) x 4.270" (W) x 0.531" (H) 	LL-2448	911289-00-02	N/A	Max Trays: 8 Single: 192 Mass: 32 (384 fiber) Mechanical: 12	N/A	N/A
Single Fuse: 12 Mass Fuse: N/A 7.139" (L) x 4.294" (W) x 0.370" (H) 	LL-2450	91957-00	Max Trays: 1 Single: 12 Mass: N/A	N/A	N/A	Max Trays: 2 Single: 24 Mass: N/A
Single Fuse: N/A Mass Fuse: 12 (144 fiber) 12.542" (L) x 4.270" (W) x 0.531" (H) 	LL-4848	911437-00-02	N/A	Max Trays: 8 Single: N/A Mass: 96 (1152 fiber)	N/A	N/A
Single Fuse: N/A Mass Fuse: 8 (96 fiber) 7.139" (L) x 4.294" (W) x 0.370" (H) 	LL-4850	91958-00	Max Trays: 1 Single: N/A Mass: 8 (96 fiber)	N/A	N/A	Max Trays: 2 Single: N/A Mass: 16 (192 fiber)
Single Fuse: 12 Mass Fuse: 8 (96) 7.139" (L) x 4.294" (W) x 0.370" (H) 	LL-1248	911221-00-00	Max Trays: 1 Single: 12 Mass: 8 (96 fiber)	N/A	N/A	Max Trays: 2 Single: 24 Mass: 16 (192 fiber)

continued

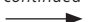





Splice Trays

LightLink Fiber Optic Splice Trays (cont.)

Ordering information – Splice Trays for Aerial Weathertight Fiber Optic Splice Closures

DESCRIPTION	MODEL NO.	AFL NO.	LG-410-U	LG-500-U	LG-600-U
Single Fuse: N/A Mass Fuse: 4 (48 fiber) 12.542" (L) x 4.270" (W) x 0.531" (H) 	LL-4800	91711-07	Max Trays: 3 Single: N/A Mass: 12 (144 fiber)	Max Trays: 3 Single: N/A Mass: 12 (144 fiber)	Max Trays: 8 Single: N/A Mass: 32 (384 fiber)

Ordering Information—Splice Trays for Fiber Optic Enclosures

DESCRIPTION	MODEL NO.	AFL NO.	LL-400B WITH INTERCONNECT	LL-400B WITHOUT INTERCONNECT	LL-400SX WITH 2 LGX® PLATES	LL-400SX WITHOUT LGX PLATES
Single Fuse: 24 Mass Fuse: 4 (48 fiber) Mechanical : 12 12.542" (L) x 4.270" (W) x 0.531" (H) 	LL-2448	911289-00-02	Max Trays: 4 Single: 96 Mass: 16 (192 fiber) Mechanical: 48	Max Trays: 6 Single: 144 Mass: 24 (288 fiber) Mechanical: 72	Max Trays: 3 Single: 72 Mass: 12 (144 fiber) Mechanical: 36	Max Trays: 9 Single: 216 Mass: 36 (432 fiber) Mechanical: 108
Single Fuse: 48 Mass Fuse: N/A 12.542" (L) x 4.270" (W) x 0.531" (H) 	LL-2448-48S	FA000045	Max Trays: 4 Single: 192 Mass: N/A	Max Trays: 6 Single: 288 Mass: N/A	Max Trays: 3 Single: 144 Mass: N/A	Max Trays: 9 Single: 432 Mass: N/A
Single Fuse: N/A Mass Fuse: 12 (144 fiber) 12.542" (L) x 4.270" (W) x 0.531" (H) 	LL-4848	911437-00-02	Max Trays: 4 Single: N/A Mass: 48 (576 fiber)	Max Trays: 6 Single: N/A Mass: 72 (864 fiber)	Max Trays: 3 Single: N/A Mass: 36 (432 fiber)	Max Trays: 9 Single: N/A Mass: 108 (1296 fiber)
Single Fuse: N/A Mass Fuse: 4 (48 fiber) 12.542" (L) x 4.270" (W) x 0.531" (H) 	LL-4800	91711-07	Max Trays: 4 Single: N/A Mass: 16 (192 fiber)	Max Trays: 6 Single: N/A Mass: 24 (288 fiber)	Max Trays: 3 Single: N/A Mass: 12 (144 fiber)	Max Trays: 9 Single: N/A Mass: 108 (1296 fiber)

continued
→

LightLink Fiber Optic Splice Trays (cont.)

Ordering Information—Splice Trays for Fiber Optic Enclosures

DESCRIPTION	MODEL NO.	AFL NO.	LL-500	LL-580
Single Fuse: N/A Mass Fuse: 12 (144 fiber) 12.000" (L) x 5.125" (W) 0.485" (H) 	LL-7144	FA000043	N/A	Max Trays: 2 Single: N/A Mass: 24 (288 fiber)
Single Fuse: 60 Mass Fuse: 12 (144) 12.000" (L) x 5.125" (W) 0.485" (H) 	LL-7644	FA000044	N/A	Max Trays: 2 Single: 120 Mass: 24 (288 fiber)
Single Fuse: 12 Mass Fuse: N/A 7.139" (L) x 4.294" (W) x 0.370" (H) 	LL-2450	91957-00	Max Trays: 5 Single: 60 Mass: N/A	N/A
Single Fuse: N/A Mass Fuse: 8 (96 fiber) 7.139" (L) x 4.294" (W) x 0.370" (H) 	LL-4850	91958-00	Max Trays: 3 Single: N/A Mass: 24 (288 fiber)	N/A
Single Fuse: 36 Mass Fuse: 12 (144 fiber) 8.125" (L) x 4.875" (W) x 0.485" (H) 	LL-4808L-R	FA000037	N/A	Max Trays: 2 Single: 72 Mass: 24 (288 fiber)

continued
→

LightLink Fiber Optic Splice Trays (cont.)

Ordering Information – Splice Tray for Splicing Cabinets and Shelves

DESCRIPTION	MODEL NO.	AFL NO.
Telescoping Splice Tray - Stores up to 48 single fusion sleeves or 12 mass fusion sleeves (144 fibers). For use in the following products: LL-300, LL-288/576, LL-720/1440, OTSS-SYS1, OSS-SYS2 and OSS-SYS1	STF-48	911442-00-00
FTTx Splice Tray - Stores up to 2 single fusion sleeves. For use in the following products: ONT-760XL, ONT-3000 and CG-1500	—	DM000445
Bare Fiber Splice Tray - Stores up to 24 single fusion fibers without sleeves. For use in the following products: Any product that accepts the LL-2400 splice tray	—	C184190

Ordering Information—Splice Tray Accessories

DESCRIPTION	AFL NO.
FP-40 Splice Protection Sleeves, 40 mm length (1000 box/100 pack)	S015916
FP-60 Splice Protection Sleeves, 60 mm length (1000 box/100 pack)	S015915
Single Fusion Splice Chip - 6 splices per chip. (10 pcs. per kit)	FA000034
Single Fusion Splice Chip - 12 splices per chip. (10 pcs. per kit)	FC000657
Single Fusion Splice Chip - 24 splices per chip. (10 pcs. per kit)	91745-02
Mass Fusion Splice Chip - 4 splices per chip. (10 pcs. per kit)	FA000088
Mechanical Fusion Splice Tape (10 pcs. per kit)	FA000089
Core Tube Cable Fiber Router for routing fiber up to 8 directions. For all central core tube sizes.	FC000008
Loose Tube or Ribbon Router for routing fiber up to 6 directions. For all Loose Tube and up to 12 fiber Ribbon.	FC000070

Dimensions

LL-2448 and LL-4848 Splice Trays

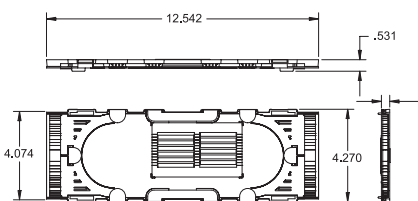

LL-1248, LL-2450 and LL-4850 Splice Trays

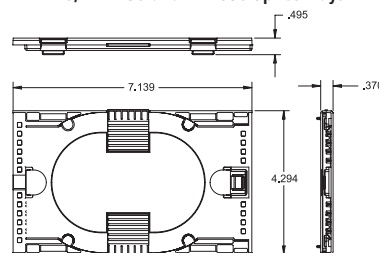

LL-2400 Splice Tray

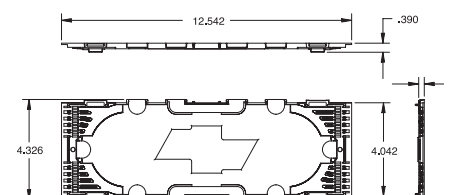

LL-4896 Splice Tray

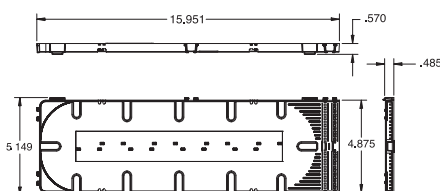

LL-2425 Splice Tray

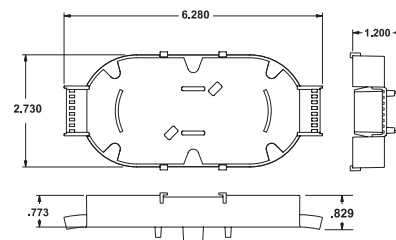

OEE Splice Tray

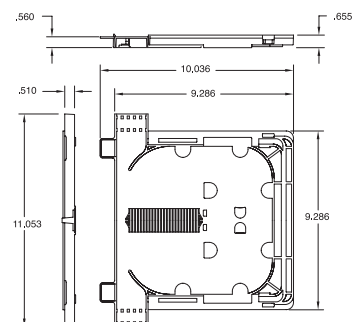



Fiber Storage Units

AFL Fiber Storage Units (FSU) are used to conveniently and safely store an extra length of cable along the support strand for later use. Furnished as pairs (kit contains two Fiber Storage Units and two sets of hanger brackets), these FSU's are constructed from either aluminum with a baked acrylic enamel finish or dielectric polypropylene with a UV inhibitor. All basic hardware for attachment to the support strand is provided. Strand mount support brackets meet Telcordia® specifications. Galvanized strand clamping devices accommodate 1/4" to 7/16" strand and meet ASTM specifications A153 and B695.

Features

- Small profile and side facing channel minimizes ice and leaf loading
- Metal versions feature an all aluminum construction with welded cross members and baked acrylic enamel paint finish with chromate pre-finish per MIL-6-5541-B
- Plastic versions feature thermoplastic polypropylene resin with carbon black UV inhibitor
- Basic hanging hardware (bolts, nuts, washers) and strand clamps all included
- Tie-wrap slots for securing cable from sliding
- Galvanized strand clamps accommodate 1/4" to 7/16" strand



Reserve Cable Storage



Butt Splice



In-Line Splice

Specifications

PARAMETER	FSU-10	FSU-12	FSU-16	FSU-18	FSU-20	FSU-24
Nom. Channel Width in. (cm)	0.63 (1.60)	0.92 (2.34)	1.12 (2.84)	1.75 (4.45)	1.75 (4.45)	1.745 (4.5)
Min. Bend Diameter in. (cm)	10 (25.4)	12 (30.48)	16 (40.64)	18 (45.72)	20 (50.80)	24.125 (61.3)

PARAMETER	FOSP-12-TMK	FOSP-17-TMK
Nom. Channel Width in. (cm)	0.63 (1.59)	0.95 (2.41)
Min. Bend Diameter in. (cm)	12.13 (30.80)	17.5 (44.45)

Ordering Information

DESCRIPTION	FSU-10	FSU-12	FSU-16	FSU-18	FSU-20	FSU-24
FSU Kit	911107-00	911108-00	911109-00	911110-00	911944-00-00	FA000095

DESCRIPTION	FOSP-12-TMK	FOSP-17-TMK
FOSP Kit (Dielectric)	FA000004	FA000002

Kits contain one pair of either FSU or FOSP and four mount brackets.

Qualifications

GOVERNING BODY	STANDARD CODE
ASTM	ASTM A153, ASTM B695
Telcordia	MIL-6-5541-B

Hardware Diagram

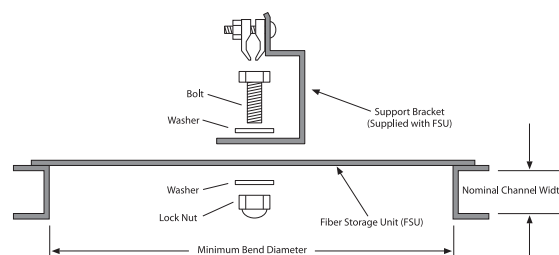



Fiber Storage Units for ADSS Fiber Optic Cable

AFL Fiber Storage Units (FSU) are used to conveniently store an extra length of cable along the ADSS cable run for later use. Furnished as pairs (kit contains two Fiber Storage Units and two sets of hanger brackets), these FSUs are constructed from UV stabilized PPE thermoplastic. All basic hardware for attachment to the ADSS cable is provided. ADSS cable mount support brackets meet Telcordia® specifications. Epoxy coated clamping devices meet ASTM specifications A153 and B695.

Features

- Small profile and side facing channel minimizes ice and leaf loading
- Constructed from UV stabilized PPE thermoplastic
- Basic hanging hardware (bolts, nuts, washers) and strand clamps all included
- Tie-wrap slots for securing cable
- Epoxy-coated strand clamps

The mounting bracket features an angled, tent-profile, epoxy-coated bracket for standard ADSS cable mounting.

Specifications

PARAMETER	FOSP-ADSS-12	FOSP-ADSS-17
Nominal Channel Width - in. (cm)	0.625	1.00
Minimum Bend Diameter - in. (cm)	12	17.5

Ordering Information

DESCRIPTION	FOSP-ADSS-12	FOSP-ADSS-17
FOS ADSS Kit	FA000049	FA000050

Kits contain one pair of FOSP and two sets of hanger brackets.

Qualifications

GOVERNING BODY	STANDARD CODE
ASTM	ASTM A153, ASTM B695

Typical Installation Diagram

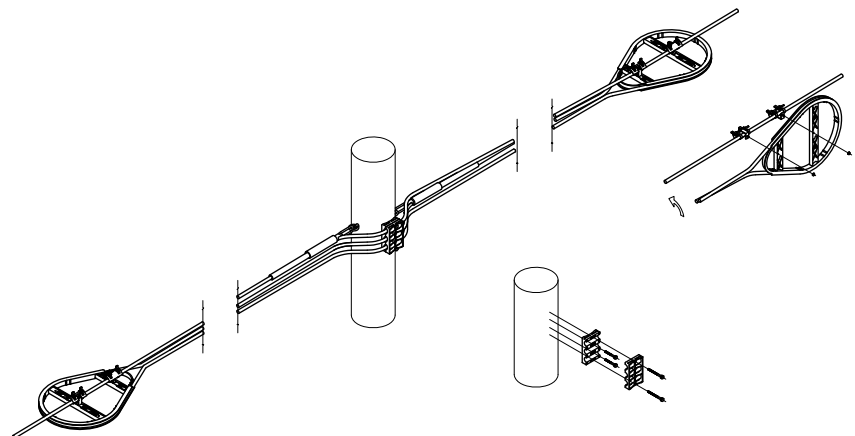



 Bluetooth®

90S+



In Work Tray



Wind Protector Open

Fujikura 90S+ Fusion Splicer

The Fujikura 90S+ core alignment fusion splicer solves common problems seen in the field—from splicing poor quality legacy fiber to automated equipment maintenance and upkeep. The Fujikura 90S+ can be use in multiple field splicing applications including bend-insensitive fibers in drop cables, long-haul terrestrial and submarine LEAF® fibers, loose buffer fiber, splice-on connectors, and the list goes on. The speed and accuracy of the 90S+ make it suitable for certain production and specialty environments where high output, tight packaging, and low loss requirements are required.

Regardless of your scenario, the Fujikura 90S+ is designed to keep you in the field with an extended battery life of 300 splice and heat cycles. With its multiple automated and easy-to-use features, the 90S+ alleviates the need for traditional operation tasks such as frequent arc calibrations, cleaver blade rotations, cleaver usage tracking, and manual splicing operations. A redesigned work tray, cooling tray, and optional cable clamp make the 90S+ kit more versatile than its predecessors in adapting to varying work conditions and environments.

When splicing loose buffer fiber, additional sheath clamps are not needed. The standard universal sheath clamp now handles both loose and tight buffer fibers. The new Active Fusion Control (AFC) technology improves splice losses for fibers that possess a poor cleave angle. Combined with Active Blade Management between the splicer and cleaver, the Fujikura 90S+ contains a robust set of splicing features that will reduce the likelihood of poor splice installations or repairs.

Features

- Cleaver tracking and upkeep with wireless communication
- Improved real-time arc control for fibers with poor cleave angles
- Automated wind protector, sheath clamps and splice operation
- Loose and tight buffer with same sheath clamp
- Lithium-ion battery with 300 splices/shrinks per charge
- PC software and 90S+ manual downloaded from splicer
- Multi-function transit case with integrated workstation

Applications

- Distribution fiber repair
- Long-haul network installation
- Field termination with splice-on connectors
- Access network installation
- Fanout kits, pigtailed and splice cassettes
- OSP cable installation and repair
- Optical modules – splitters, couplers, MUXs, EDFAs and attenuators

STOCK ITEM

Fujikura 90S+ Fusion Splicer

Ordering Information

DESCRIPTION	AFL NO.
90S+ Fusion Splicer (machine only) Includes: ADC-20 AC Adapter, ACC-14 AC Cord, BTR-15 Battery, ELCT2-16B Spare Electrodes (pair), Sheath Clamps, SP-03 Fiber Holder Set Plates, USB-01 Cable, Alcohol Dispenser, Screwdriver, Splicer Carrying Strap, Quick Reference Guide, TS-03 Tripod Screw, Work Tray J-Plate, SS03 single fiber stripper, CC39 Transit Case with Carrying Strap and Two Year Warranty	S017519
90S+ Fusion Splicer Kit (with cleaver) Includes: CT50 Cleaver, ADC-20 AC Adapter, ACC-14 AC Cord, BTR-15 Battery, ELCT2-16B Spare Electrodes (pair), Sheath Clamps, SP-03 Fiber Holder Set Plates, USB-01 Cable, Alcohol Dispenser, Screwdriver, Splicer Carrying Strap, Quick Reference Guide, TS-03 Tripod Screw, Work Tray J-Plate, SS03 single fiber stripper, CC39 Transit Case with Carrying Strap and Two Year Warranty	S017521
90S+ Fusion Splicer without Bluetooth (machine only) Includes: ADC-20 AC Adapter, BTR-15 Battery, ACC-14 AC Cord, ELCT2-16B Spare Electrodes (pair), Sheath Clamps, SP-03 Fiber Holder Set Plates, USB-01 Cable, Alcohol Dispenser, Screwdriver, Splicer Carrying Strap, Quick Reference Guide, TS-03 Tripod Screw, Work Tray J-Plate, SS03 Single Fiber Stripper, CC39 Transit Case with Carrying Strap and Two Year Warranty	S017520
One Year Extended Warranty	S012996
Two Year Extended Warranty	S013000

Recommended Products for the 90S+

DESCRIPTION	AFL NO.
Cleavers	
CT08 Cleaver	S017004
CT50 Cleaver	S017030
Fiber Holders (pair)	
FH-70-250 (250 µm coated fiber)	S017111
FH-70-900 (900 µm jacketed fiber)	S017113
FH-70-160 (160 µm coated fiber)	S017095
FH-70-200 (200 µm coated fiber)	S017711
FH-60-LT900 (Loose buffer 900 µm fiber)	S015181
FUSEConnect® Accessories	
FH-FC-20 (900 µm within 2.0 mm sheathing) (each)	S014696
FH-FC-30 (900 µm within 3.0 mm sheathing) (pair)	S014695
FH-FC-900 (900 µm cable) (each)	S014697
CLAMP-FC-2000 (pair)	S014705
CLAMP-FC-3000 (pair)	S014704
Power Supply Options and Equipment	
ADC-20 AC Adapter	S017513
ACC-14 AC Power Cord	S014536
BTR-15 Battery	S017512
DCC-20 Power Cord (connects AC Adapter to cigarette lighter socket)	S017527
DCC-21 Power Cord (connects AC Adapter to power source via alligator clips)	S017528

DESCRIPTION	AFL NO.
Miscellaneous	
SS03 Single fiber stripper (3 hole)	S017098
SS01 Single fiber stripper (1 hole)	S017099
ELCT2-16B Electrodes	S017103
SP-03 Fiber Holder Set Plates	S017518
S90 Universal Sheath Clamps	S017696
Portable Tripod Workstation (see product profile for more detail)	S014773
ASW-02 Splicing Workstation (see product profile for more detail)	S010532
WT-09R Work Tray Right	S017515
WT-09L Work Tray Left	S017516
JP-09 Work Tray J-Plate	S017517
JP-10 J-Plate (Cooling tray attaches to splicer)	S017522
JP-10-FC J-Plate with Fiber Clamps	S017523
TS-03 Tripod Screw (90 Series)	S017524
ST-02 Fusion Splicer Strap	S017525
CLAMP-DC-12 (Drop cable clamp for work tray)	S017550
USB-01 Cable	S014777
CC39 Transit Case	S017514
Splicer V-Groove Cleaning Kit	S014397



Fiber Holders

- Wide range of sizes for various applications
- Loose & Tight Buffer options available



Portal Tripod Work Station

- Sturdy work tray supports the splicer, cleaver and accessories
- Tripod supports a load capacity of up to eleven pounds



V-Groove Cleaning Kit

- Removes environmental contamination from the v-groove of the splicer
- Maintains performance and ensures fiber alignment

Fujikura 90S+ Fusion Splicer

Specifications

PARAMETER		VALUE
Fiber Alignment Method		Active core alignment
Fiber Count Can Be Spliced		Single fiber
Applicable Fiber	Fiber Type	Single-mode optical fiber
	Cladding Diameter	Multimode optical fiber
Applicable Coating	Sheath Clamp	80 to 150 μm
	Coating dia.:	Max. 3,000 μm
Fiber Splice Performance	Splice Loss	Cleave length: 5 to 16 mm
		ITU-T G.652: Avg. 0.02 dB
		ITU-T G.651: Avg. 0.01 dB
		ITU-T G.653: Avg. 0.04 dB
		ITU-T G.654: Avg. 0.04 dB
		ITU-T G.655: Avg. 0.04 dB
	ITU-T G.657: Avg. 0.02 dB	
Splice Time	SM FAST mode: Avg. 8 to 10 sec.	
	SM AUTO mode: Avg. 11 to 13 sec. AUTO mode: Avg. 14 to 16 sec.	
Applicable Protection Sleeve	Sleeve Type	Heat-shrinkable sleeve
	Sleeve Length	Max. 66 mm
	Sleeve Dia.	Max. 6.0 mm before shrinking
Sleeve Heat Performance	Heat Time	60 mm slim mode: Avg. 9 to 10 sec.
		60 mm mode: Avg. 13 to 15 sec.
Fiber Tensile Test Force		Approx. 2.0 N
Electrode Life		Approx. 5,000 splices
Physical Description	Dimensions W	Approx. 170 mm without projection
	Dimensions D	Approx. 173 mm without projection
	Dimensions H	Approx. 150 mm without projection
	Weight	Approx. 2.8 kg including battery
Environmental Condition	Temperature	Operate: -10 to 50°C
		Storage: -40 to 80°C
	Humidity	Operate: 0 to 95% RH non-condensing Storage: 0 to 95% RH non-condensing
Altitude	Max. 5,000 m	
AC Adaptor	Input	AC100 to 240 V, 50/60 Hz, Max. 1.5 A
Battery Pack	Type	Rechargeable Lithium Ion
	Output	Approx. DC14.4V / 6,380 mAh
	Capacity	Approx. 300 splice and heat cycles
	Temperature	Recharge: 0 to 30°C Storage: -20 to 30°C
	Battery Life	Approx. 500 recharge cycles
Display	Recharge Time	Approx. 5-8 hours from empty
	LCD Monitor	TFT 5 inches with touch screen
Illumination	Magnification	200 to 320x
	V-Grooves	LED lamp
Interface	PC	USB2.0 Mini B type
	External Led Lamp	USB2.0 A type, Approx. DC5V, 500 mA
	Ribbon Stripper	Mini DIN 6 pin, DC12V, Max. 1A
	Wireless	Bluetooth 4.1 LE
Data Storage	Splice Mode	100 splice modes
	Heat Mode	30 heat modes
	Splice Result	20,000 splices
	Splice Image	100 images
Screw Hole For Tripod		1/4-20 UNC
Other Features	Automatic Functions	Splice mode select by fiber type analysis
		Discharge power calibration
		Wind protector: open/close
		Sheath clamp: open
		Heater lid: open/close
Heater clamp: open/close		
Reference Guide	Video and PDF file stored in splicer	
Sheath Clamp	Easy sleeve positioning clamp	
Electrode	Replaceable without tool	



Fujikura 41S+ Fusion Splicer

The Fujikura 41S+ is a fully ruggedized, two camera, active cladding alignment fusion splicer. Enabled by Warm Splice Imaging (WSI), the 41S+ can determine the alignment of the fiber cores by observing the splice during the heating process. This delivers splice loss estimates with a greater level of accuracy than those based on cladding only alignment. Active Blade Management (ABM) via Bluetooth® connection with the CT50 Fiber Cleaver tracks usage and enables automated blade rotation as needed, mitigating fiber reurns. The new Active Fusion Control (AFC) technology further reduces reurns by improving splice losses for fibers with poor cleave angles. With the combination of ABM and AFC, the Fujikura 41S+ contains a robust set of splicing features that will reduce the likelihood of poor splice installations or repairs.

A 6-second splice time and 25-second shrink time offers unmatched speed and productivity, while an easy-to-use touchscreen monitor provides simple and intuitive menu navigation. Interchangeable sheath clamps or fiber holders provide versatility for user preference, and compatibility with splice-on connectors. The extended-life battery is rated for up to 200 splice and heat cycles. Long-life electrodes provide 5,000 splices and help minimize downtime for replacement and stabilization. The large 5" monitor provides a crystal-clear image, even in the brightest sunlight. Software updates are accomplished via the internet allowing users to quickly update their software as new splice programs become available.

Backed by the best service team in the industry, the Fujikura 41S+ is the ideal splicer to use when portability, ruggedness, and reliability are needed for splicing applications.



Workstation in Transit Case



Workstation on Transit Case

Features

- Warm Splice Imaging (WSI) loss estimation technology
- Improved real-time arc control for fibers with poor cleave angles
- Bluetooth enabled cleaver management
- Two camera, active cladding alignment
- 5" touchscreen monitor
- Interchangeable sheath clamps and fiber holders
- Fully ruggedized for shock, moisture and dust resistance
- Extended-life electrodes, 5,000 splices, exchangeable without tools

Ordering Information

DESCRIPTION	AFL NO.
Fujikura 41S+ Fusion Splicer Includes: Fujikura 41S+ Fusion Splicer, S31A Sheath clamps (installed), FH-70-250 Fiber Holders (pair), FH-70-900 Fiber Holders (pair), SP-01 Set Plates, ADC-19A AC Adapter, BTR-11A Battery Pack (installed), ACC-09 Power Cord, ELCT2-16B Spare Electrodes (pair), Screwdriver, Operation Manual on CD, Quick Reference Guide, SS-03 Single Fiber Stripper and CC-36 Transit Case	S017090
Fujikura 41S+ Fusion Splicer Kit with CT50 Cleaver Includes: Fujikura 41S+ Fusion Splicer, CT50 Cleaver, S31A Sheath clamps (installed), FH-70-250 Fiber Holders (pair), FH-70-900 Fiber Holders (pair), SP-01 Set Plates, ADC-19A AC Adapter, BTR-11A Battery Pack (installed), ACC-09 Power Cord, ELCT2-16B Spare Electrodes (pair), Screwdriver, Operation Manual on CD, Quick Reference Guide, SS-03 Single Fiber Stripper and CC-36 Transit Case	S017091
One Year Extended Warranty	S012996
Two Year Extended Warranty	S013000

Fujikura 41S+ Fusion Splicer

Recommended Accessories

DESCRIPTION	AFL NO.
Cleavers	
CT50 Cleaver	S017030
CT08 Cleaver	S017004
Fiber Holders	
FH-70-250 Fiber Holder (pair)	S017111
FH-70-900 Fiber Holder (pair)	S017113
FH-60-LT900 Fiber Holder (pair)	S015181
Batteries	
BTR-11A Battery Pack	S017354
FUSEConnect® Accessories	
FH-FC-20 (900 μm within 2.0 mm sheathing) (each)	S014696
FH-FC-30 (900 μm within 3.0 mm sheathing) (pair)	S014695
FH-FC-900 (900 μm cable) (each)	S014697
CLAMP-FC-2000 (pair)	S014705
CLAMP-FC-3000 (pair)	S014704

DESCRIPTION	AFL NO.
Miscellaneous	
CLAMP-S31A Sheath Clamps	S017100
CLAMP-S31B Sheath Clamps for loose buffer 900 μm	S017101
SP-01 Set Plate (pair)	S017106
ELCT2-16B Electrodes	S017103
ADC-19A AC Adapter	S017104
ACC-09 Power Cord	S014390
CC-36 Transit Case	S017105
USB Cable	S014777
Splicer V-Groove Cleaning Kit	S014397
SS03 Single Fiber Stripper (3 hole)	S017098
SS01 Single Fiber Stripper (1 hole)	S017099

Single Fiber Splicers

Fujikura 41S+ Fusion Splicer

Specifications

PARAMETER		VALUE
Fiber alignment method		Active cladding alignment
Fiber count can be spliced		Single fiber
Applicable optical fiber	Fiber type	Single mode optical fiber Multi mode optical fiber
	Cladding dia.	Approx. 125 μm
Applicable coating	Sheath clamp	Coating dia. : Max. 3000 μm Cleave length : 5 to 16 mm
	Splice loss	ITU-T G.652 : Avg. 0.03 dB ITU-T G.651 : Avg. 0.01 dB ITU-T G.653 : Avg. 0.05 dB ITU-T G.655 : Avg. 0.05 dB ITU-T G.657 : Avg. 0.03 dB
Fiber splice performance	Splicing time	SM FAST mode : Avg. 6 sec. AUTO mode : Avg. 9 sec.
	Sleeve type	Heat shrinkable sleeve
Applicable protection sleeve	Sleeve length	Max. 66 mm
	Sleeve dia.	Max. 6 mm before shrinking
	Heat time	60 mm mode : Avg. 26sec.
Sleeve heat performance	Heat time	60 mm mode : Avg. 26sec.
Fiber tensile test force		Approx. 2.0 N
Electrode life		Approx. 5,000 splices
Physical description	Dimensions W	Approx. 131 mm without projection
	Dimensions D	Approx. 201 mm without projection
	Dimensions H	Approx. 79 mm without projection
	Weight	Approx. 1.3 kg including battery
Environmental condition	Temperature	Operate : -10 to 50°C Storage : -40 to 80°C
	Humidity	Operate : 0 to 95% non-condensing Storage : 0 to 95% non-condensing
	Altitude	Max. 5,000m
AC adaptor	Input	AC 100 to 240V, 50/60Hz, Max. 1A
	Type	Rechargeable Lithium Ion
	Output	Approx. DC 14.4V, 3360mA
Battery pack	Capacity	Approx. 200 splice and heat cycles
	Temperature	Recharge : 0 to 40°C Storage : -20 to 30°C
	Battery life	Approx. 500 recharge cycles
Display	LCD monitor	TFT 5.0 inches with touch screen
	Magnification	132 to 300x
Illumination	V-grooves	LED lamp
Interface	PC	USB2.0 MINI B type
	Wireless	Bluetooth® 4.1 LE
Data storage	Splice mode	100 splice modes
	Heat mode	30 heat modes
	Splice result	10,000 results
	Fiber image	100 images
Screw hole for tripod		1/4-20UNC
Other features	Automatic functions	Fiber heat calibration
	Sheath clamp	Easy sleeve positioning
	Loss Estimate	Warm splice image estimation
	Electrode	Tool less replaceable electrode



Portable Tripod Workstation Kit (splicer and cleaver not included)



Cleaver mount assembly swings into and out of the work space



Portable Work Tray showing the four mounting positions of the cleaver mount assembly (delivered as shown)

Portable Tripod Workstation

As splicing requirements have migrated from aerial to ground level locations, a sturdy splicing workstation with the ability to adjust for uneven ground surfaces has been missing from the splicing marketplace. That problem is solved with AFL's Portable Tripod Workstation – the critical missing link in splicing productivity.

The Portable Tripod Workstation offers both a sturdy work tray to support the splicer, cleaver and accessories, and a tripod to support the work tray. The two can be purchased together as a kit or separately for those users who prefer to use their own tripod or mounting mechanism.

The work tray incorporates a unique cleaver mounting system that offers flexibility and convenience for the user. The cleaver mounting arm pivots into and out of the work space, as needed, and securely captures the CT50, CT-20 and CT-04 style cleavers. The base of the cleaver mounting assembly can be moved to any one of four positions on the tray to accommodate user preferences.

The tripod is solidly constructed but lightweight, weighing less than six pounds, and collapses to a length of only twenty-five inches. The telescoping legs offer flexible height adjustments from thirteen inches to sixty-one inches and the leg angle can be increased for unusual surfaces.

Features

- Sturdy work tray supports the splicer, cleaver and accessories
- Tripod supports a load capacity of up to eleven pounds
- Independent telescoping tripod legs support uneven work surfaces
- Leveraged handles securely lock work tray into position
- Cleaver mount assembly swings cleaver into and out of the work space
- Optional cleaver mounting positions accommodate user preferences
- Compatible with all FSM-17, FSM-18, FSM-50, FSM-60 and 12/19/70 series models

Ordering Information

DESCRIPTION	AFL NO.
Portable Tripod Workstation Kit – Includes: Tripod with pan head and quick release platform (make and model of tripod may change without notice), portable work tray with cleaver mount assembly and canvas carrying case	S014773
Portable Work Tray – Includes: Portable work tray with cleaver mount assembly and canvas carrying case	S014753
Tripod – Includes: Tripod with pan head and quick release platform (make and model of tripod may change without notice)	S014751

Optional Accessories

DESCRIPTION	AFL NO.
TS-01 TRIPOD SCREW (required for 12S & 12R models)	S015895



Splicing Workstation



Aerial mounting system

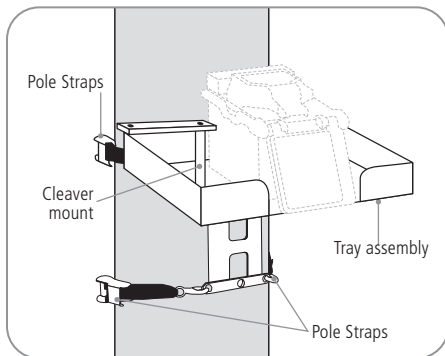

Pole Mounting System

**Illustration for reference only.*

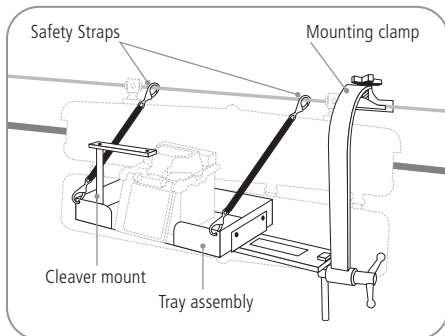

Aerial Mounting System

**Illustration for reference only.*

ASW-02 Splicing Workstation

The ASW-02 Splicing Workstation can be used with a fusion splicer and cleaver in aerial or terrestrial splicing applications. The ASW-02 provides a stable work surface and secure mounting of the splicer and cleaver to prevent accidental drops and equipment damage in challenging splicing locations.

The ASW-02 Splicing Workstation consists of the work tray, a convenient pivoting cleaver mounting arm, a post for attachment to bucket or ladder mounting accessories, a tripod mount, and dual safety straps. An aerial mounting system is available for direct attachment of the workstation to a telephone pole, or for suspending the workstation from an aerial cable strand. The strand mounting system is fully adjustable to provide for optimal location of the workstation when minimal slack fiber is available, such as in a taut-sheath cable access scenario.

In the aerial environment, the safety straps may be secured to the cable strand to provide security and aid with workstation position adjustment. The safety straps are also used to secure the workstation to the pole, and may be used to raise or lower the workstation.

Features

- Provides direct to pole mounting as well as direct adjustable attachment to aerial strand
- Mounting post provided for attachment to bucket and ladder mounting accessories (utilizing any popular copper splicer-head mounting rigs)
- Tripod mount allows for placement in tight FTTH splicing applications
- Includes cable tie locations to secure cables during splicing
- Optimized to simplify taut sheath splicing applications
- Cleaver mount securely captures cleaver and allows operator to rotate it in and out of the workspace as needed
- Matte finish minimizes glare
- Compatible with all FSM-17, FSM-18, FSM-50, FSM-60 and 19/70 series models

Ordering Information

DESCRIPTION	AFL NO.
ASW-02 Splicing Workstation (Full kit with aerial mounting system) Includes aerial mounting system to provide strand and pole mounting capability, a post for attachment to bucket or ladder mount accessories and a receptacle for tripod mounting and safety straps	S010532
ASW-02 Splicing Workstation (Without aerial mounting system) Includes a post for attachment to bucket or ladder mount accessories and a receptacle for tripod mounting	S013620



CT08 Fiber Cleaver

The CT08 cleaver is an extremely rugged, durable, and easy to use single fiber cleaver. Ideal for FTTH applications, the CT08 provides unmatched levels of impact resistance and also eliminates the requirement for tools during blade rotation. A thumbwheel on the bottom of the cleaver is utilized for blade rotation, and the blade position indicator has been relocated to enable quick and easy viewing. The top clamp opens to a position past vertical allowing for easy viewing, cleaning, and adjustment of the cleave length. The blade is retracted automatically when opening the top clamp and is activated upon closing, making this a true one-step cleaver. The cleaver blade and fiber clamping mechanism is extremely easy to replace in the field. A manual scrap collector is included.

Features

- Dedicated for single fiber cleaving
- Ruggedized design withstands extreme shock levels
- Tool free blade rotation
- Simple one-step operation
- Blade and clamp/anvil assembly are field serviceable



Shown in CC-34 Carrying Case



Specifications

ITEM		VALUE
Applicable Fiber	Fiber type	Single mode optical fiber Multi mode optical fiber
	Fiber count	Single fiber
	Cladding dia.	Approx. 125 μm
Applicable Coating	Fiber plate	AD-50 : Max. 3 mm coating diameter
	Fiber holder	Coating shape. : Refer to splicer fiber holder options
Cleave Length	Fiber plate	AD-50 [CD = coating diameter] CD= 250 μm or less : 5 to 20 mm 250 μm < CD < 1000 μm : 10 to 20 mm 1000 μm < CD < 3 mm : 14 to 20 mm
	Fiber holder	Approx. 10mm
Cleave Angle	Single fiber	Avg. 0.3 to 0.9 degrees
Blade Life		Approx. 48,000 fiber cleaves
Physical description	Dimensions W	Approx. 120 mm when closing the lever
	Dimensions D	Approx. 95 mm when closing the lever
	Dimensions H	Approx. 58 mm when closing the lever
	Weight	Approx. 185 g
Environmental condition	Temperature	Operate : -10 to 50°C Storage : -40 to 80°C
	Humidity	Operate : 0 to 95% non-condensing Storage : 0 to 95% non-condensing
Screw hole for tripod		1/4-20UNC
Other features	Blade rotation	Manual rotation dial
	Replaceable parts	Blade Clamp arm

CT08 Fiber Cleaver

Ordering Information

DESCRIPTION	APPLICATION	FIBER HANDLING SYSTEM	CLEAVE LENGTH	AFL NO.
CT08 Includes: AD-50 Adapter Plate, CC-34 Carrying Case, Hex Wrench, Scrap Collector and Instruction Manual	Single Fibers: 160 to 900 µm coating, 125 µm cladding	Purchased separately FH-70-250 FH-70-900	See Specifications Table on previous page	S017004

Accessories

DESCRIPTION	AFL NO.
AD-50 Single Fiber Adapter Plate	S017010
AD-10-M24 Fiber Plate	S017335
SPA-CT08-10 Spacer	S017011
CC-34 Transit Case	S017012
CB-07 Replacement Blade for CT08 Cleaver	S017013
ARM-CT08-01 Replacement Arm Set	S017014
SC-CT08-01 Side Cover	S017015
BRW-CT08-01 Blade Rotary Wheel	S017110
FDB-04 Fiber Dust Box	S017120



Shown in CC-37 Carrying Case

Features

- Motorized blade rotation
- Bluetooth communication
- Shock resistant
- Simple one-step operation
- 60,000 cleave blade life
- Field serviceable



CT50 Fiber Cleaver

The CT50 features automated blade rotation, unprecedented durability, and simplistic maintenance unseen with any other cleaver. Paired with a Bluetooth enabled Fujikura splicer, cleaver blade positions can be automatically advanced when needed based on cleave count or cleave quality. If automated rotation is not desired, the blade position can be advanced at the touch of a button, no tools required. The easy to read blade position indicator clearly displays the selected position. The Bluetooth® feature, along with simplified mechanical operation, increases overall productivity and reliability. The fiber clamp opens beyond 90 degrees and readies the blade for cleaving in the same motion. This allows easy viewing of the distance scale used to gauge cleave length. The 16-position blade yields 60,000 single-fiber cleaves, or 5,000 12-fiber ribbon cleaves. The built-in scrap collector conveniently stores fiber shards until they can be safely discarded.

The CT50 is an industry first cleaver ruggedized to withstand severe shock, including drops up to 30 inches. If needed, the CT50 is field serviceable with all precision components easily replaced in the field.

Specifications

ITEM		VALUE
Applicable Fiber	Fiber type	Single-mode optical fiber
	Fiber count	Multimode optical fiber
	Cladding dia.	Single up to 16 fibers
Applicable Coating	Fiber plate	Approx. 125 µm
	Fiber holder	AD-10-M24 : Max. 900 µm coating diameter AD-50 : Max. 3mm coating diameter
Cleave Length	Fiber plate	Coating shape. : Refer to splicer fiber holder options
	Fiber holder	AD-10-M24 : 5 to 20 mm for CD ≤ 250 µm AD-50 [CD = coating diameter] CD= 250µm or less : 5 to 20 mm 250 µm < CD < 1000µm : 10 to 20 mm 1000 µm < CD < 3 mm : 14 to 20 mm
Cleave Angle	Single fiber	Approx. 10 mm
	Fiber ribbon	Avg. 0.3 to 0.9 degrees
Blade Life		Avg. 0.3 to 1.2 degrees
Physical description	Dimensions W	Approx. 60,000 fiber cleaves
	Dimensions D	Approx. 120 mm when closing the lever
	Dimensions H	Approx. 95 mm when closing the lever
	Weight	Approx. 58 mm when closing the lever
Environmental condition	Temperature	Approx. 305 g including battery and AD-10-M24
	Humidity	Operate : -10 to 50°C Storage : -40 to 80°C
Battery		Operate : 0 to 95% non-condensing Storage : 0 to 95% non-condensing
Wireless interface		2 pieces of LR03/AAA dry battery
Screw hole for tripod		Bluetooth 4.1 LE
Other features	Blade rotation	1/4-20UNC
	Replaceable parts	Motorized rotation
		Manual rotation dial
	Blade	
	Clamp arm	

Continued >

CT50 Fiber Cleaver

Ordering Information

DESCRIPTION	APPLICATION	FIBER HANDLING SYSTEM	CLEAVE LENGTH	AFL NO.
CT50	Single or Ribbon Fiber	AD-10-M24 adapter plate for single fibers or fiber holders for ribbons	See Specifications table on previous page	S017030

Accessories

DESCRIPTION	AFL NO.
CB-08 Replacement Blade	S017076
FDB-05 Scrap Collector Box	S017121
AD-50 Adapter Plate	S017010
AD-10-M24 Fiber Plate	S017335
ARM-CT50-01 Replacement Arm Set	S017122
BRW-CT08-01 Blade Rotary Wheel	S017110
SC-CT50-01 Side Cover	S017108
CC-37 Transit Case	S017077
SPA-CT-08-10 Spacer	S017011
FDB-05 Fiber Dust Box	S017121

Splice+ is a smartphone application that works in cooperation with Fujikura's splicers, cleavers and ribbon fiber strippers which have Bluetooth capability.

Get the **Splice+** app at the Apple App store or at Google Play.



Splice Protection Sleeves

AFL offers a wide selection of fiber protection sleeves to meet any application. The FP series is the industry standard for durable and lasting protection of single fiber splices in field installations, while the FP-04(T) and FP-05 provide the same durable protection for 8 and 12 fiber ribbon respectively.

The FPS01 and FPS04 series are specially designed for optical components, where small packaging is a priority. These micro sleeves provide the known reliability of Fujikura sleeves in the smallest possible lengths. This easy and cost effective method is a great alternative to recoating. The FPS01 and FPS04 series offer a wide range of options to accommodate various coating sizes, and are manufactured in a variety of lengths. This gives great flexibility in designing optical modules.

Standard Sleeves: Dimensions & Applicable Fiber

SLEEVES FOR SINGLE FIBERS 250 MICRONS TO 900 MICRONS

DESCRIPTION	SLEEVE LENGTH	FIBER CLEAVE LENGTH	SLEEVE DIAMETER AFTER SHRINK	PACKAGING	AFL NO.
FP-60	60 mm	16 mm	3.1 mm (max.)	1000 Box/100 Pack	S015915
FP-40	40 mm	10 mm	3.1 mm (max.)	1000 Box/100 Pack	S015916

SLEEVES FOR UP TO 250 MICRON COATED RIBBON

DESCRIPTION	FIBER COUNT	SLEEVE LENGTH	FIBER CLEAVE LENGTH	SLEEVE DIAMETER AFTER SHRINK	PACKAGING	AFL NO.
FP-04(T)	Up to 8 fibers	40 mm	10 mm	4.0 mm (max.)	250 Box/25 Pack	S002105
FP-05	Up to 12 fibers	40 mm	10 mm	4.5 X 4.0 mm (max.)	250 Box/5 Pack	S003027
FP-05-28	Up to 12 fibers	28 mm	10 mm	4.5 mm (max.)	250 Box/25 Pack	S014720
FPS04-30	Up to 4 fibers	30 mm	10 mm	2.4 mm (max.)	1,000 Box/25 Pack	S010848
FPS08-28	Up to 8 fibers	28 mm	10 mm </td <td>3.3 X 2.7 mm (max.)</td> <td>500 Box/25 Pack</td> <td>S013560</td>	3.3 X 2.7 mm (max.)	500 Box/25 Pack	S013560
FPS24-40	Up to 24 fibers	40 mm	10 mm	8.0 X 4.0 mm (max.)	200 Box/5 Pack	S013004

Specifications

PARAMETER	DESCRIPTION	VALUE
Outer tube	FP-60/40/03 series	Polyolefin based on Polyethylene
	FPS-04(T) / FP-05	Ethylene-Vinyl Acetate
Inner Tube	ALL	Ethylene-Vinyl Acetate
Strength member	FP-60/40/03 series	Stainless steel
	FP-04(T) / FP-05	Heat-resistant glass
Operation condition (after shrink)		-10 to 50°C, 0 to 95% RH (Non dew)
Storage condition (before shrink)		-40 to 60°C, Non dew

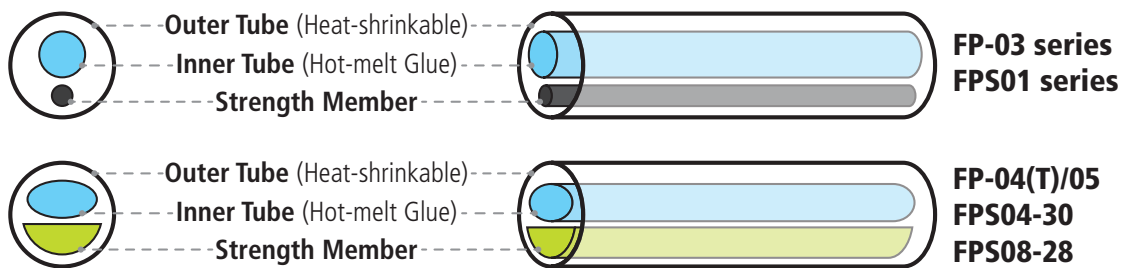

Splice Protection Sleeves

Micro Sleeves: Dimensions & Applicable Fiber

FPS01-400 SERIES FOR SINGLE FIBERS UP TO 400 MICRON FIBER

DESCRIPTION	SLEEVE LENGTH	FIBER CLEAVE LENGTH	SLEEVE DIAMETER AFTER SHRINK	PACKAGING	AFL NO.
FPS01-400-12	12 mm	4 mm	1.5 mm	50 Pack	S014088
FPS01-400-15	15 mm	5 mm	1.5 mm	50 Pack	S012668
FPS01-400-20	20 mm	8 mm	1.5 mm	50 Pack	S012672
FPS01-400-25	25 mm	10 mm	1.5 mm	50 Pack	S012676
FPS01-400-34	34 mm	15 mm	1.5 mm	50 Pack	S012680
FPS01-400-40	40 mm	16 mm	1.5 mm	1,250 Box	S011914

FPS01-900 SERIES FOR SINGLE FIBERS UP TO 900 MICRON FIBER

DESCRIPTION	SLEEVE LENGTH	FIBER CLEAVE LENGTH	SLEEVE DIAMETER AFTER SHRINK	PACKAGING	AFL NO.
FPS01-900-15	15 mm	4 mm	2.3 mm	50 Pack	S012684
FPS01-900-20	20 mm	6 mm	2.3 mm	50 Pack	S012688
FPS01-900-25	25 mm	6 mm	2.3 mm	50 Pack	S011954
FPS01-900-34	34 mm	13 mm	2.3 mm	50 Pack	S012692
FPS01-900-45	45 mm	16 mm	2.3 mm	50 Pack	S012696

Specifications

PARAMETER	DESCRIPTION	VALUE
Outer tube	FPS01 series / FPS04-30 / FPS08-28 / FPS24-40	Polyolefin based on Polyethylene
Inner Tube	ALL	Ethylene-Vinyl Acetate
Strength member	FPS01 series	Stainless steel
	FPS04-30 / FPS08-28 / FPS24-40	Heat-resistant glass
Operation condition (after shrink)		-10 to 50°C, 0 to 95% RH (Non dew)
Storage condition (before shrink)		-40 to 60°C, Non dew

Type Variations

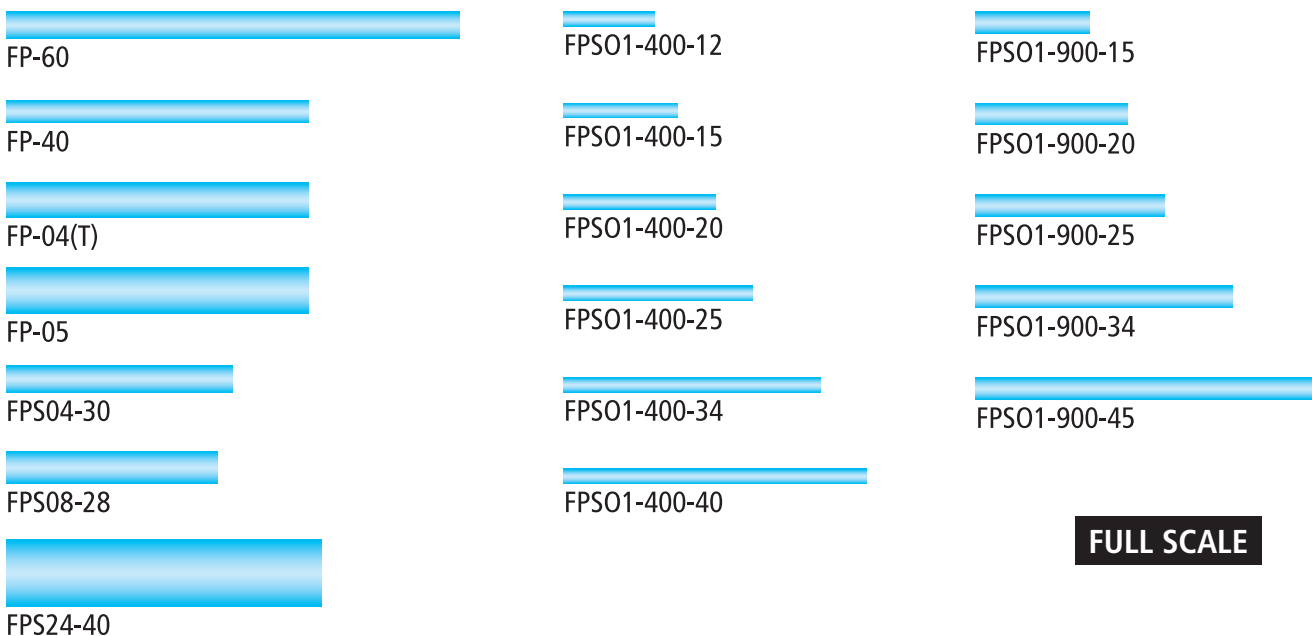

FlexScan® FS300 Quad OTDR

Be ready for anything with this all-in-one solution



Features

- Multimode and Single-mode OTDR, including PON test
- SmartAuto® 1-button automated testing for fast results
- Pocket-sized, weighs less than 1 pound, 12-hour battery
- LinkMap® color-coded icons for easy troubleshooting
- Integrated Source, Power Meter and VFL
- Robust reporting including Print-to-PDF
- Available with field-replaceable connector

Applications

- OTDR and insertion loss test and reporting
- Fast, accurate Pt-to-Pt and PON verification and troubleshooting
- Locate faults exceeding industry or user pass/fail thresholds
- Visually pinpoint location of macrobends or breaks

AFL's FlexScan FS300 Quad OTDR is an all-in-one solution for detecting, identifying, locating and resolving single-mode and multimode optical network issues. It is designed for both novice and expert technicians working in a range of environments from data centers to fiber-to-the-home, as well as local and wide area networks. The FlexScan FS300 automates test setup, shortens test time and simplifies results interpretation, improving efficiency and reducing costs.

All-in-one test capability: The FlexScan FS300 includes an integrated VFL, power meter and light source. It can be easily paired to AFL's award-winning FOCIS family of inspection scopes for single-fiber and/or MPO and OptiTip® multifiber inspection, ensuring technicians have everything they need to locate and resolve optical network issues.

Performance-packed: With SmartAuto automated multi-pulse acquisition, 37 dB dynamic range and best-in-class dead zones, FlexScan Quad OTDRs test multimode and single-mode networks – including FTTH PONs and POLANs up to 1:64 split ratio – while still detecting and measuring events <2 meters apart.

User-friendly: The FS300 enables both expert and novice technicians to quickly and accurately detect, locate, identify and measure optical network components and faults. It applies industry-standard or user-set pass/fail criteria and displays results using LinkMap color-coded icons that immediately show the health of the network.

Pocket-sized: The FlexScan FS300's small form factor still delivers 12-hour battery operation plus a large, bright, indoor/outdoor, 5-inch 800 x 480 touchscreen display that doesn't need a stylus.

Multiple Reporting Options: Reports can be generated directly from the unit using Print-to-PDF feature or files can be transferred wirelessly or uploaded via USB to the included Windows® compatible TRM® 3.0 Test Results Manager software.

Field-replaceable connector: With AFL's optional field-replaceable connector, avoid expensive service repairs to replace connectors damaged due to poor cleaning practices and/or normal wear-and-tear.

FlexScan® FS300 Quad OTDR

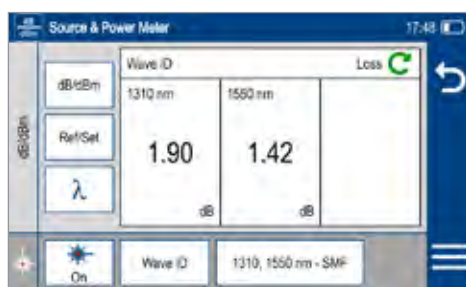
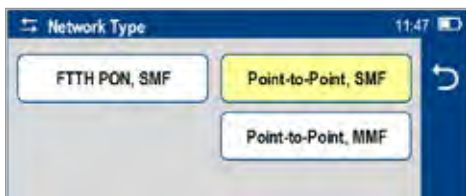
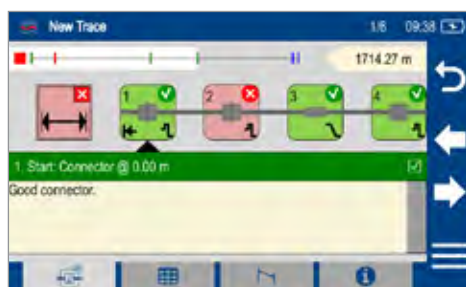

Dramatically Reduces Test Time

In SmartAuto mode, FlexScan OTDRs automatically analyze and test the network using a variety of network-optimized settings to precisely locate, characterize and identify network events with one button push. Loss and reflectance are measured for connectors, splices, splitters and macro-bends. FlexScan even checks for live fiber and verifies OTDR launch quality before initiating a test.

Simplifies Network Troubleshooting

LinkMap® color-coded icons enable even novice users to easily and accurately troubleshoot optical networks. LinkMap clearly identifies fiber start, end, connectors, splices, PON splitters, and macro-bends.

A LinkMap Summary provides end-to-end link length, loss and ORL. Loss and reflectance of detected events is compared to industry-standard or user-defined pass/fail thresholds and displayed with clear pass/fail indications. Users can instantly toggle between LinkMap and Trace views.

Multimode and Single-mode plus PON Testing in One OTDR

FlexScan Quad OTDRs are the ideal test tool for verifying and/or maintaining both single-mode and multimode networks. Unlike most Quad OTDRs, FS300 OTDRs test both point-to-point networks and FTTH PONs/Passive Optical LANs (POLANs).

Connectivity

FlexScan OTDRs easily pair with AFL's ward-winning FOCIS® family of connector inspection probes for fast, easy single-fiber and/or multi-fiber connector end-face inspection. Images and pass/fail results can be transferred to the FlexScan for display and/or archiving with OTDR results.

FlexScan results can be transferred wirelessly via the free FlexScan App to a smart device for real-time reporting using the included Windows-based TRM® 3.0 Test Results Manager software. Monitoring test results in real-time can detect mistakes while the tech is still in the field, preventing future truck rolls.

OTDR, OLTS, and VFL Testing with a Single Tool

FlexScan optionally includes a Wave ID optical light source (OLS) and optical power meter (OPM). With Wave ID, the OPM auto-synchronizes to a single or multi-wavelength Wave ID optical signal transmitted by an AFL light source. The OPM reports detected wavelengths and measures power and loss at each wavelength, saving significant test time and eliminating setup errors.

The integrated Visual Fault Locator's eye-safe red laser enables users to visually pinpoint the location of macro-bends and fiber breaks often found in splice closures and fiber cabinets.

FlexScan® FS300 Quad OTDR

Specifications^a

OTDR	MULTIMODE	SINGLE-MODE
Emitter Type	Laser	
Safety Class ^b	Class I	
Fiber Type	Multimode; compatible with OM1-OM5	Single-mode; compatible with all G.65x
Wavelengths ^c	850/1300 ±20 nm	1310/1550 ±20 nm
Network Type	Point-to-point	Point-to-point & PON up to 1:64
Connector Type	User-specified APC or UPC ferrule with interchangeable UCI adapters	
Dynamic Range ^d	≥29/29 dB @ 850/1300 nm	≥37/36 dB @ 1310/1550 nm
Event Dead Zone ^e	≤0.8 m @ 850/1300 nm typical	≤0.8 m @ 1310/1550 nm typical
Attenuation Dead Zone ^f	≤3.0 m	≤3.5 m
PON Dead Zone ^g	Not applicable	≤25 m
Pulse Widths	3, 5, 10, 20, 30, 50, 100, 200, 300, 500 ns; 1 μs	3, 5, 10, 20, 30, 50, 100, 200, 300, 500 ns; 1, 2, 3, 5, 10, 20 μs
Range Settings	250 m to 30 km	250 m to 240 km
Data Points	Up to 300,000	
Data Spacing	≥5 cm to ≤16 m	
Group Index of Refraction	1.3000 to 1.7000	
Distance Uncertainty	±(1 + 0.0025% x distance + data point spacing) m	
Linearity	±0.03 dB/dB	
Loss Resolution	0.001 dB	
Reflectance Range	850 nm: -20 to -58 dB; 1300 nm: -20 to -63 dB	1310/1550 nm: -20 to -65 dB
Reflectance Resolution	0.01 dB	
Reflectance Accuracy	±2 dB	
ORL Range	20 to 60 dB	
ORL Resolution	0.01 dB	
ORL Accuracy	±2 dB over range 30 to 55 dB; ±4 dB over range 20-30 dB and 55-60 dB	
Trace File Format	.SOR, Telcordia SR-4731 Issue 2	
OTDR Results Storage	Internal or external USB memory	
Internal Storage	Minimum 4 GB internal non-volatile memory (App SW + >5000 traces typical)	
Internal Launch Fiber	≥30 m internal MM launch fiber	≥50 m internal SM launch fiber
OTDR Modes	Supports SmartAuto, Expert, Real-Time for PON & point-to-point networks	
Real-time Refresh Rate	1 to 4 Hz	
Live Fiber Protection	No OTDR damage when connected to live fiber delivering ≤ +18 dBm at wavelength(s) in range 825 to 1675 nm	
Live Fiber Detection	Reports live fiber with input signal ≥ -35 dBm for wavelength(s) in range 825 to 1675 nm	

Notes:

- All specifications valid at 25 °C unless otherwise specified.
- FDA 21 CFR 1040.10 & 1040.11, IEC 60825-1: 2014.
- Measured with laser in CW mode at 23 °C ±3 °C.
- SNR=1, longest range and pulse width, 3 minute averaging.
- Maximum distance between two points 1.5 dB down each side of a reflective peak caused by an event with a -45 dB (or smaller) reflectance. Test pulse width is 3 or 5 ns.
- Maximum distance from the start of a trace spike caused by an event with a -45 dB (or smaller) reflectance, to the point where the trace returns to and stays within ±0.5 dB of backscatter. Test pulse width is 3 or 5 ns.
- Recovery to within 0.5 dB of backscatter after 1:16 splitter (≤13 dB loss) using 100 ns pulse width.

FlexScan® FS300 Quad OTDR

Specifications^a

OPM - OPTICAL POWER METER (P1 Option)	
Calibrated Wavelengths	850, 1300, 1310, 1490, 1550, 1625, 1650 nm
Detector Type	InGaAs PIN, 2 mm diameter
Measurement Range	+3 to -70 dBm (+3 to -65 dBm @ 850 nm)
Tone Auto-Detect	270 Hz, 330 Hz, 1 kHz, 2 kHz
Tone Detect Range	+3 to -50 dBm @1300, 1310, 1550 nm; +3 to -40 dBm @850 nm;
Wave ID	Auto-synchronizes & measures 1, 2 or 3 wavelengths
Wave ID Range	+3 to -50 dBm @1300, 1310, 1550 nm; +3 to -40 dBm @850 nm
Accuracy	±5% @ -10 dBm
Linearity	±0.1 dB (-3 to -40 dBm); ±0.25 dB (-40 to -70 dBm)
Resolution	0.01 dB
Measurement Units	Power in dBm, nW, µW, mW; Loss in dB

OLS - OPTICAL LIGHT SOURCE (P1 Option)	
Wavelengths	850/1300/1310/1550 nm
Emitter Type	Laser
Safety Class	Class I ^b
Launch Condition	Controlled Launch at 850 nm (comparable to encircled flux on OM4 fiber)
Center λ (CW Mode)	±20 nm
Spectral Width	5 nm maximum (FWHM, CW Mode)
Internal Modulation	270 Hz, 330 Hz, 1 kHz, 2 kHz, CW, Wave ID
SM Output Stability	Short-term ^c : ±0.1 dB; Long-term ^d : ±0.05 dB
MM Output Stability	Short-term ^e : ±0.20 dB; Long-term ^f : ±0.15 dB
Output Power	1310/1550 nm: -7 dBm ±1.5 dB (CW, G.652.C/D) 1300 nm: -7 dBm ±1.5 dB (CW, 50 µm MMF) 850 nm: 0 dBm ±1.5 dB (CW, 50 µm MMF)

VFL - VISUAL FAULT LOCATOR	
Emitter Type	Laser, Class IIIa / Class 3R ^b
Wavelength	635 nm ±10 nm
Output Power	1.5 mW (~+2 dBm ±0.5 dB) into SMF-28
Modes	CW and 1 Hz flashing

Notes:

- a. All specifications valid at 25 °C unless otherwise specified.
- b. FDA 21 CFR 1040.10 and 1040.11, and IEC 60825-1:2014.
- c. Typical maximum deviation over 15 minute after 15 minute warm-up.
- d. Typical maximum deviation over 8 hours after 1 hour warm-up.
- e. 15 minutes after 30 minutes warm-up.
- f. 8 hours after 1 hour warm-up.

GENERAL	
Size (in boot)	98 x 175 x 52.5 mm
Weight	0.8 kg
Operating Temperature	-10 °C to +50 °C, 0 to 95% RH (non-condensing)
Storage Temperature	-30 °C to +70 °C, 0 to 95% RH (non-condensing, battery removed) -20 °C to +60 °C, 0 to 95% RH (non-condensing, battery installed)
Power	Rechargeable Lithium polymer battery; AC adapter
AC Adapter	100-240 VAC, 50-60 Hz input; 5VDC, 2A output
Battery Life (OTDR)	≥12 hours, Telcordia test conditions, 4 hours recharge
Display	5-inch color LCD, 800 x 480 pixels, backlit
Shock and Vibration	GR-196-CORE, drop test, 0.75 m (30 in.), 6 planes
Dust Protection	GR-196-CORE, rubber dust caps for all ports
OTDR/OLS Ports	MM: UPC; SM: UPC or APC; includes tool-free, interchangeable SC adapters
OPM and VFL Ports	Universal, 2.5 mm adapter (SC, FC, ST); others available
USB Ports	USB host port; micro-USB function port
Bluetooth Interface	W1 option; compatible with Windows PC and Android
WiFi Interface	W1 option; compatible with IEEE 802.11 / WLAN
CE Safety	Compliant with EN61010-1
CE EMI/RFI	EN55011, EN61326-1, GR-196-CORE 4.5.1
RoHS	Compliant with RoHS directive 2011/65/EU

FlexScan® FS300 Quad OTDR

FlexScan FS300 models are available in five kit configurations: Basic, PLUS, PRO, BIPM, and MPO. All kits include FS300 with AC charger, battery, carry strap, SC/2.5 mm connector adapters, TRM® 3.0, quick reference user guide, and carry case.

Ordering Information

FS300-325 Basic, Plus, PRO, BIPM kits Order Entry: **FS300-325-[KIT]-[Pn]-[Wn]-[C]-[CC]-[LNG]-[AC]-[SMFR]-[MMFR]-[TIP]**

FS300-325 MPO kits (SMF and MMF) Order Entry: **FS300-325-[MKIT]-P1-[Wn]-[LNG]-[AC]-[MPOC]** where:

[KIT]	FS300 FlexScan Kit Configuration
BAS	Includes: FS300, soft case, TRM® 3.0 Basic, USB cable ^a
PLUS	Includes: BAS kit plus 150 m SMF & MMF Fiber Rings, One-Click Cleaner, upgrade to TRM 3.0 Advanced, user-selected soft or hard carry case
PRO	Includes: PLUS kit plus FOCIS Flex with two user-selected adapter tips
BIPM	Includes: PRO kit plus OFI-BIPMe

[MKIT]	FS300-325 MPO Kit Configuration
SMPO	SMF MPO test kit; Includes SMF MPO switch, launch cables, carry case
MMPO	MMF MPO test kit; Includes MMF MPO switch, launch cables, carry case

[PN]	OPTICAL LIGHT SOURCE (OLS) and Optical Power Meter (OPM)
P0	No OLS, no OPM
P1	850/1300 MM; 1310/1550 SM Source and Power Meter

[WN]	Bluetooth/WiFi Configuration
W0	No Bluetooth or WiFi
W1^b	Includes WiFi and Bluetooth

[C]	OTDR / Source Connector Type
A	APC (recommended)
U	UPC

[CC] ^c	Carry Case Option
S1	Standard soft case for FlexScan, Fiber Rings, FOCIS Flex, accessories (Basic, PLUS, PRO kits only)
S2	Large soft case for FlexScan, Fiber Rings, FOCIS Flex, OFI-BIPMe, accessories (PLUS, PRO, BIPM kits only)
H1	Hard carry case (PLUS, PRO, BIPM Kits only)

[LNG]	Language
ENG	English
CHS	Chinese Simp.
CHT	Chinese Trad.
CZE	Czech
DEU	German
DNK	Danish

[LNG]	Language
FIN	Finnish
FRA	French
ITA	Italian
JPN	Japanese
KOR	Korean
NOR	Norwegian

[LNG]	Language
POL	Polish
POR	Portuguese
SPA	Spanish
TUR	Turkish
VNM	Vietnamese

[AC]	Destination Country	AC Plugs
US	USA	2-pin, US
EU	European Union	2-pin, EU
UK	United Kingdom	3-pin, UK
CN	China, Australia	2-pin, SAA

Notes:

- Results can be transferred from FlexScan to TRM® 3.0 using USB cable, or performed wirelessly (W1 option) after downloading FlexScan App from 'Google play' or 'App Store'.
- FlexScans equipped with Bluetooth option (W1) support Bluetooth transfer of results via FlexScan App for remote reporting using TRM 3.0.
- Basic kit always ships with S1 (Standard Soft Case); MPO kit always ships with MPO-specific soft case.

[SMFR]	150 m SMF Fiber Ring
Absent	N/A in Basic kits
USC/USC	FR-SMF-150-USC-USC
USC/UFC	FR-SMF-150-USC-UFC
USC/ULC	FR-SMF-150-USC-ULC
USC/UST	FR-SMF-150-USC-UST
USC/ASC	FR-SMF-150-USC-ASC
USC/AFC	FR-SMF-150-USC-AFC
USC/ALC	FR-SMF-150-USC-ALC
USC/UE2	FR-SMF-150-USC-UE2
ASC/UFC	FR-SMF-150-ASC-UFC
ASC/ULC	FR-SMF-150-ASC-ULC
ASC/UST	FR-SMF-150-ASC-UST
ASC/ASC	FR-SMF-150-ASC-ASC
ASC/AFC	FR-SMF-150-ASC-AFC
ASC/ALC	FR-SMF-150-ASC-ALC
ASC/AE2	FR-SMF-150-ASC-AE2

[MMFR]	150 m OM1 (62.5 μm) Fiber Ring
Absent	N/A in Basic kits
USC/UST1	FR-OM1-150-USC-UST
USC/USC1	FR-OM1-150-USC-USC
USC/ULC1	FR-OM1-150-USC-ULC
USC/UFC1	FR-OM1-150-USC-UFC

[MMFR]	150 m OM2 (50 μm) Fiber Ring
Absent	N/A in Basic kits
USC/UST2	FR-OM2-150-USC-UST
USC/USC2	FR-OM2-150-USC-USC
USC/ULC2	FR-OM2-150-USC-ULC
USC/UFC2	FR-OM2-150-USC-UFC

[MMFR]	150 m OM3/4/5-compatible Fiber Ring
Absent	N/A in Basic kits
USC/UST3	FR-OM3-150-USC-UST
USC/USC3	FR-OM3-150-USC-USC
USC/ULC3	FR-OM3-150-USC-ULC
USC/UFC3	FR-OM3-150-USC-UFC

[TIP]	FOCIS Flex Tips and Cleaning (PRO only)
Blank	Option not available in Basic and PLUS kits
SC	SC-UPC bulkhead tip, 2.5 mm UPC ferrule tip, 2.5 mm One-Click
FC	FC-UPC bulkhead tip, 2.5 mm UPC ferrule tip, 2.5 mm One-Click
LC	LC-UPC bulkhead tip, 1.25 mm UPC ferrule tip, 1.25 mm One-Click
ASC	SC-APC bulkhead tip, 2.5 mm APC ferrule tip, 2.5 mm One-Click
AFC	FC-APC bulkhead tip, 2.5 mm APC ferrule tip, 2.5 mm One-Click
ALC	LC-APC bulkhead tip, 1.25 mm APC ferrule tip, 1.25 mm One-Click

[MPOC]	MPO Launch Cable Network Connector
F	Female (unpinned)
M	Male (pinned)

FlexScan® FS300 Quad OTDR

Ordering Information (continued)

Accessories

DESCRIPTION	AFL NO.
FlexScan wrist strap	1400-05-0230PZ
FlexScan neck strap, 36"	1400-05-0231PZ
AC charger 100-240 VAC to 5 VDC	4050-00-0931PR
Soft carry case for FS300 with FOCIS, OFI, and Fiber Ring	1400-01-0167PZ
Soft carry case for FS300-325 MPO kits	1400-20-0001PZ
Soft carry case for FS300 with FOCIS, and Fiber Ring	1400-20-0002PZ
Hard carry case for FS300 kits with FOCIS, OFI, and Fiber Ring	1400-01-0177PZ
FS300 extended temperature replacement battery	3900-06-0902MR
Vehicle charger, 12VDC to 5VDC @2A	4050-00-0033MR
Cable, USB-micro B, 5 pin, 6'	6000-00-0031MR
5V USB charging cable (1.5 m), type A to barrel (0.9 X 3.2 X 9 mm)	6000-00-0034PR
One-Clicks, fluid, wipes, etc. See www.AFLglobal.com	Cleaning Supplies

Field-Replaceable OTDR Connector (Optical Port Ferrule Saver)

Protect your OTDR ports from damage due to mating with dirty or damaged launch cables or patch cords or normal wear-and-tear. Equip your FlexScan FS300 with a field-replaceable connector, which installs in seconds and accepts AFL's tool-free interchangeable SC, LC, FC and ST connector adapters.

Replace damaged connectors in the field: When normal wear-and-tear or poor cleaning practices damage the port saver's end-face, replace it in seconds without having to return the OTDR to a service center for an expensive and time-consuming repair.

DESCRIPTION	AFL NO.
Field-replaceable connector; APC female to APC male	2900-58-0001MR
Field-replaceable connector; APC female to UPC male	2900-58-0002MR
Field-replaceable connector; UPC female to APC male	2900-58-0003MR
Field-replaceable connector; UPC female to UPC male	2900-58-0004MR

Connector Adapters

CONNECTOR ADAPTER	AFL NO.		
	OTDR/OLS PORT	OPM PORT	VFL PORT
FC	2900-50-0002MR	2900-52-0001MR	N/A
SC	2900-50-0003MR	2900-52-0002MR	N/A
ST	2900-50-0004MR	2900-52-0003MR	N/A
LC	2900-50-0006MR	2900-52-0004MR	N/A
SC/APC	2900-50-0011MR	N/A	N/A
2.5 mm Universal	N/A	2900-52-0005MR	2900-50-0007MR
1.25 mm Universal	N/A	2900-52-0006MR	2900-50-0010MR

FlexScan® FS300 Quad OTDR

Test Management and Reporting Software

DESCRIPTION	AFL NO.
TRM® 3.0 with Basic License (OTDR Trace/OLTS Viewer, Batch Editor and Reports), USB delivery (included with all FS300 kits)	TRM3-BASIC
TRM 3.0 upgrade from Basic to Advanced License, USB delivery	TRM3-UPGRADE
TRM 3.0 upgrade from Basic to Advanced License, email delivery	TRM3-UP-EMAIL
FlexScan App (Android Google play)	Free Download

Recommended Products



FOCIS Flex and FOCIS Lightning (Multi-Fiber) Connector Inspection

- Self-contained, tether-free, hand-held inspection solution
- Auto-focus and auto-centering for fast, easy inspection
- IEC, IPC and user-defined pass/fail analysis
- FOCIS Lightning: extremely fast multi-fiber auto-analysis for datacom and telecom inspection applications



OFI-BIPMe Optical Fiber Identifier

- World class signal sensitivity
- Trigger lock, positive stop for optimum detection
- Integrated optical power meter option

Qualifications

CATEGORY	REGULATION/STANDARD	QUALIFICATION
CE Marking	EU	Compliant to relevant EU Directives on health, safety, and environmental protection, and certified with CE marking
Safety/EMC/EMI	IEC	Compliant to IEC 61010-1 for safety requirements for electrical equipment
	EN	Compliant to EN 61010-1 for safety requirements for electrical equipment
	IEC	Compliant to IEC 61326-1 for EMC requirements for electrical equipment
	EN	Compliant to EN 61326-1 for EMC requirements for electrical equipment
	EN	Compliant to EN 55011 for EMC requirements for industrial, scientific and medical equipment
	Telcordia	Compliant to GR-196-CORE 4.5.1 for requirements on electromagnetic interference
	FCC	Compliant to code of federal regulations FCC 47 CFR 15 on unlicensed transmissions
	FDA	Compliant to code of federal regulations FDA 21 CFR 1040.10 and 1040.11 on laser products
RoHS	IEC	Compliant to IEC 60825-1 for safety of laser products
	EU	Compliant to EU regulations Directive 2011/65/EU (RoHS 2) and Directive 2015/863 (RoHS 3)
Test Method	TIA	Compliant to TIA-568.3-D for test and measurement requirements for premises optical fiber cabling and components
	IEC	Compliant to IEC 11801 for test and measurement requirements for optical fiber cabling for use within premises
	AS/NZS	Compliant to AS/NZS 3080 for test and measurement requirements for optical fiber cabling for use within premises
	TIA	Compliant to TIA-526-7 for test procedures for installed optical fiber cable plant
	TIA	Compliant to TIA-526-14 for test procedures for installed optical fiber cable plant
	IEC	Compliant to IEC 14763-3 for systems and methods for the inspection and testing of installed optical fiber cabling
	AS/NZS	Compliant to AS/NZS 14763.3 for systems and methods for the inspection and testing of installed optical fiber cabling
	IEC	Compliant to IEC 61280-4-1 for test procedures for installed optical fiber cable plant
Generic Requirement	IEC	Compliant to IEC 61280-4-2 for test procedures for installed optical fiber cable plant
	Telcordia	Compliant to GR-196-CORE for generic requirements for OTDR-type equipment
	Telcordia	Compliant to SR-4731 Issue 2 for OTDR data format
	IEC	Compliant to IEC 61746-1 for requirements on calibration of OTDR

Contact Sales@AFLglobal.com to schedule a demonstration or learn how to buy.

Visit www.AFLglobal.com/Test to learn more about FlexScan FS300 OTDR.

International Sales and Service Contact Information available at www.AFLglobal.com/Test/Contacts

FlexScan® FS200 Single-mode OTDR

Pocket-sized, Performance-packed, User-friendly, and Affordable



Features

- Flexpress® mode completes OTDR tests in <5 seconds
- Test up to 1:64 PON with 25 m PON dead zone
- Easy to understand LinkMap® results with pass/fail indications
- Single, dual or triple wavelength single-mode
- Single port for in- and out-of-service OTDR tests
- Integrated source, power meter, VFL (visual fault locator)
- Integrated MPO Switch control via USB
- Rugged, lightweight, hand-held for field use
- Available with field-replaceable connector

Applications

- PON or point-to-point network verification or troubleshooting
- OTDR testing plus insertion loss and power measurements
- Locate faults exceeding industry or user pass/fail thresholds
- Visually pinpoint location of macro-bends or breaks

AFL's FlexScan FS200 OTDR is an all-in-one solution for detecting, identifying, locating, and resolving single-mode optical network issues. It is designed for both novice and expert technicians working in a range of environments, from FTTH PON to point-to-point networks. It applies industry-standard or user-set pass/fail criteria and displays results using LinkMap color-coded icons that immediately show the health of the network. The FlexScan FS200 automates test setup, shortens test time, and simplifies results interpretation improving efficiency and reducing costs.

All-in-one test capability: The FlexScan FS200 includes an integrated VFL, power meter, and light source. It can be easily paired to AFL's award-winning FOCIS family of inspection scopes, ensuring technicians have everything they need to locate and quickly resolve optical network issues.

Performance-packed: With SmartAuto multi-pulse acquisition, up to 37 dB dynamic range, and best-in-class 25 m PON dead zone, FlexScan FS200 PON OTDRs test FTTH PONs up to 1:64 while still detecting and measuring events only meters apart.

Fast! Flexpress mode completes dual-wavelength tests in <5 seconds – 10 x faster than conventional OTDRs! For multi-fiber testing, FS200s automatically control AFL's MFS Multi-Fiber Switch (12-fiber MPO switch) to further reduce multi-fiber test time.

Pocket-sized: At 3.5 x 6 x 1.75 in. (86 x 160 x 43 mm) and less than one pound (0.4 kg), FlexScan FS200 OTDRs truly fit in your pocket, yet still provide a large, bright indoor/outdoor touchscreen display, and all-day operation.

Multiple sharing and reporting options: Results can be stored internally, saved to a USB, or wirelessly uploaded via the free FlexScan App for real-time reporting using the included TRM® 3.0 Test Results Manager software.

Convenient cost-saving kits: Bundle the FlexScan FS200 with your choice of launch cable, FOCIS Flex connector inspection probe and tips, and/or AFL's universal optical fiber identifier (OFI-BIPMe) for significant cost-savings!

Field-replaceable connector: With AFL's optional field-replaceable connector, avoid expensive service repairs to replace connectors damaged due to poor cleaning practices and/or normal wear-and-tear.

FlexScan® FS200 Single-mode OTDR



Dramatically Reduces Test Time

In SmartAuto mode, FlexScan OTDRs automatically analyze and test the network using a variety of network-optimized settings to precisely locate, characterize and identify network events with one button push. Loss and reflectance are measured for connectors, splices, splitters and macro-bends. FlexScan even checks for live fiber and verifies OTDR launch quality before initiating a test.

FlexScan's new Flexpress mode completes dual-wavelength tests in seconds, reducing test time by a factor of 10x compared to conventional OTDRs. For multi-fiber testing, Flexpress mode automatically controls AFL's MPO Switch, testing 12 fibers at the touch of a single button.



Simplifies Network Troubleshooting

LinkMap with pass/fail enables even novice users to easily and accurately troubleshoot optical networks. LinkMap presents an icon-based view of the tested network clearly identifying fiber start, end, connectors, splices, PON splitters, and macro-bends.

A LinkMap summary provides end-to-end link length, loss and ORL. Loss and reflectance are displayed with clear pass/fail indications. Users can instantly toggle between LinkMap and Trace views.



Connectivity

FlexScan OTDRs easily pair with AFL's ward-winning FOCIS® family of connector inspection probes for fast, easy single-fiber and/or multi-fiber connector end-face inspection.

FlexScan results can then be transferred wirelessly via the free FlexScan App to a smart device for real-time reporting using the included Test Results Manager (TRM 3.0) PC-based software. This real-time monitoring can help avoid mistakes in the field that will require future truck rolls.

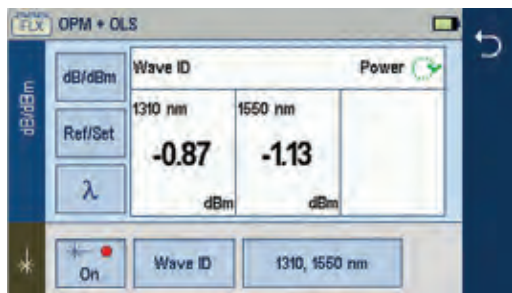

OTDR, OLTS, and VFL Testing with a Single Tool

FlexScan optionally includes a Wave ID optical light source (OLS) and optical power meter (OPM). With Wave ID, the OPM auto-synchronizes to a single or multi-wavelength Wave ID optical signal transmitted by an AFL light source. The OPM reports detected wavelengths and measures power and loss at each wavelength, saving significant test time and eliminating setup errors.

The integrated VFL's eye-safe red laser enables users to visually pinpoint the location of macro-bends and fiber breaks often found in splice closures and fiber cabinets.

FlexScan® FS200 Single-mode OTDR

FlexScan OTDRs are available with 1310/1550/1625, 1310/1550/1650, 1310/1550, and 1550 or 1650 nm only wavelengths. The 1310 and 1550 nm versions are available with integrated optical light source (OLS), optical power meter (OPM), visual fault locator (VFL) and Bluetooth/WiFi.

Specifications^a

MODEL: FS200-XXX	-50	-60	-100	-300	-303	-304
OTDR						
Emitter Type	Laser					
Safety Class ^b	Class I					
Fiber Type	Single-mode					
Wavelengths (nm)	1550	1650	1310/ 1550	1310/ 1550	1310/ 1550/ 1625	1310/ 1550/ 1650
Center λ Tolerance ^c	1310/1550/1650: ± 20 nm; 1625 +30/-5 nm					
Dynamic Range ^d (dB)	28	37	32/30	37/36	37/36/37	37/36/37
Event Dead Zone ^e (m)	1.0	0.8	0.8	0.8	0.8	0.8
Atten. Dead Zone ^f (m)	6.0	3.5	3.6	3.5	3.5	3.5
PON Dead Zone ^g (m)	N/A	30	N/A	25/25	25/25/30	25/25/30
Pulse Widths	3, 5, 10, 20, 30, 50, 100, 200, 300, 500 ns; 1, 2, 3, 10 μs; 20 μs (FS200-300/300/304 only)					
Range Settings	250 m to 240 km					
Data Points	Up to 300,000 (Expert mode .SOR file)					
Data Spacing	5 cm to 16 m					
Index of Refraction	1.3000 to 1.7000					
Distance Uncertainty	±(1 + 0.003% x distance + data point spacing) m					
Linearity (dB/dB)	±0.05					
Trace File Format	Telcordia SR-4731 Issue 2 compatible .SOR					
Trace Storage Medium	4 GB internal memory (> 5000 traces typical); External USB memory stick					
Data Transfer to PC	USB cable or Bluetooth® (option)					
OTDR Modes	SmartAuto, Expert, Real-time					
Flexpress Fast Test	FS200-300/303/304					
Display Modes	LinkMap Summary, LinkMap Events, Trace					
Refresh Rate	Up to 4 Hz (Real-time mode)					
Live Fiber Protection	No OTDR damage with input power ≤ +15 dBm for wavelength(s) in range 1260 to 1675 nm					
Live Fiber Detection	Reports live fiber with input signal ≥ -35 dBm for wavelength(s) in range 1260 to 1675 nm					
PON Filter Isolation	>50 dB for 1260 nm ≤ wavelength ≤ 1600 nm					
Live PON OTDR Test	1625 or 1650 nm using filtered detector					

Notes:

- All specifications valid at 25 °C unless otherwise specified.
- FDA 21 CFR 1040.10 & 1040.11, IEC 60825-1: 2014.
- Using 10 ns pulse width.
- SNR=1, longest range and pulse width, 3-minute averaging.
- Maximum distance between two points 1.5 dB down each side of a reflective peak caused by an event with reflectance ≤ -45 dB using 3 or 5 ns pulse.
- Maximum distance from the start of a trace spike caused by an event with a -45 dB (or smaller) reflectance, to the point where the trace returns to and stays within ±0.5 dB of backscatter. Test pulse width is 3 or 5 ns.
- Recovery to within 0.5 dB of backscatter after 1:16 splitter (≤13 dB loss) using 100 ns pulse width.
- Max temperature while charging is +45 °C.

MODEL: FS200-XXX	-50	-60	-100	-300	-303	-304
VISUAL FAULT LOCATOR (VFL)						
Emitter Type	Visible red laser, 650 ±20 nm					
Safety Class ^b	Class II					
Output Power	0.8 mW into single-mode fiber (-1 dBm ±0.5 dB)					
Modes	CW, 2 Hz flashing					
OPTICAL LASER SOURCE - OLS (Optional)						
Emitter Type	Laser					
Safety Class ^b	Class I					
Fiber Type	Single-mode					
Wavelengths (nm)	1550	N/A	1310/ 1550	1310/ 1550	1310/ 1550	1310/ 1550
Center λ Tolerance	±20 nm (CW mode)					
Spectral Width (FWHM)	5 nm (maximum)					
Internal Modulation	270 Hz, 330 Hz, 1 kHz, 2 kHz, CW, Wave ID					
Wave ID	Compatible with AFL OPM/OLS					
Output Power Stability	≤ ±0.1 dB (15 minutes); ≤ ±0.15 dB (8 hours)					
Output Power	-3 dBm ±1.5 dB					
OPTICAL POWER METER -OPM (Optional)						
Calibrated Wavelengths	1310, 1490, 1550, 1625, 1650 nm					
Detector Type	InGaAs, 1 mm diameter					
Measurement Range	+23 to -50 dBm					
Tone Detect Range	+3 to -35 dBm					
Accuracy	±0.25 dB					
Resolution	0.01 dB					
Measurement Units	dB, dBm or Watts (nW, μW, mW)					
GENERAL						
Size (in boot)	86 x 160 x 43 mm					
Weight	0.4 kg					
Operational Temperature ^h	-10 °C to +50 °C, 0 to 95 % RH (non-condensing)					
Storage Temperature	-40 °C to +70 °C, 0 to 95 % RH (non-condensing)					
Power	Rechargeable Li-Pol or AC adapter					
Battery Life	>12 hours, Telcordia test conditions					
Display	4.3 in color touchscreen LCD, 480x272, backlit					
USB Ports	1 host; 1 micro-USB function					
Bluetooth (optional)	Compatible with Windows PC, Android					

FlexScan® FS200 Single-mode OTDR

FlexScan Kit Configurations

All kits include a FlexScan FS200 with AC charger, battery, carry strap, SC/2.5 mm connector adapters, TRM® 3.0, USB cable, and carry case.

Ordering Information

FS200-[MOD]-[KIT]-[PW]-[C]-[CC]-[LNG]-[AC]-[FR]-[TIP] where:

[MOD]	FS200 FlexScan OTDR Configuration
50	1550 nm only Troubleshooting OTDR
60	1650 nm filtered Live PON Troubleshooting OTDR
100	1310/1550 nm Verification and Troubleshooting OTDR
300	1310/1550 Pt-to-Pt & PON Verification and Troubleshooting OTDR
303	1310/1550/1625 Pt-to-Pt and PON Verification and Troubleshooting OTDR
304	1310/1550/1650 Pt-to-Pt and PON Verification and Troubleshooting OTDR

[KIT]	FS200 FlexScan Kit Configuration
BAS	Includes: FS200, soft case, TRM 3.0 Basic, USB cable ^a
PLUS	Includes: BAS kit plus 150 m SMF & MMF Fiber Rings, One-Click Cleaner, upgrade to TRM 3.0 Advanced, user-selected soft or hard carry case
PRO	Includes: PLUS kit plus FOCIS Flex with two user-selected adapter tips
BIPM	Includes: PRO kit plus OFI-BIPMe
MPO	MPO kit includes FlexScan plus MFS Multi-Fiber Switch, MPO launch cable, OTDR-to-Switch patch cord, OTDR-to-Switch USB cable

[PW]	Power Meter / Wireless Option
P0-W0	No Source, Power Meter, or Bluetooth/WiFi (FS200-50/60/100 only)
P0-W1 ^b	No Source or Power Meter; Includes Bluetooth/WiFi (FS200-300/304 only)
P1-W0	No Bluetooth/WiFi (-303/304 only); Includes Source, Power Meter
P1-W1 ^b	Includes Source, Power Meter, Bluetooth/WiFi (all models except -50)

[C]	OTDR / Source Connector Type
A	APC (recommended)
U	UPC

[CC] ^c	Carry Case Option (PLUS, PRO, BIPM Kits)
S1	Large soft case for FS200, fiber ring, FOCIS Flex, OFI-BIPMe, accessories
S2	Medium soft case for FS200, fiber ring, FOCIS Flex, accessories
H1	Hard carry case for FS200, fiber ring, FOCIS Flex, OFI-BIPMe, accessories

[LNG]	Language
ENG	English
CHS	Chinese Simp.
CHT	Chinese Trad.
CZE	Czech
DEU	German
DNK	Danish

[LNG]	Language
FIN	Finnish
FRA	French
ITA	Italian
JPN	Japanese
KOR	Korean
NOR	Norwegian

[LNG]	Language
POL	Polish
POR	Portuguese
SPA	Spanish
TUR	Turkish
VNM	Vietnamese

[AC]	Destination Country	AC Plugs
US	USA	2-pin, US
EU	European Union	2-pin, EU
UK	United Kingdom	3-pin, UK
CN	China, Australia	2-pin, SAA

[FR]	150 m SMF Fiber Ring
Absent	N/A in Basic kits
USC/USC	FR-SMF-150-USC-USC
USC/UFC	FR-SMF-150-USC-UFC
USC/ULC	FR-SMF-150-USC-ULC
USC/UST	FR-SMF-150-USC-UST
USC/ASC	FR-SMF-150-USC-ASC
USC/AFC	FR-SMF-150-USC-AFC
USC/ALC	FR-SMF-150-USC-ALC
USC/UE2	FR-SMF-150-USC-UE2
ASC/UFC	FR-SMF-150-ASC-UFC
ASC/ULC	FR-SMF-150-ASC-ULC
ASC/UST	FR-SMF-150-ASC-UST
ASC/ASC	FR-SMF-150-ASC-ASC
ASC/AFC	FR-SMF-150-ASC-AFC
ASC/ALC	FR-SMF-150-ASC-ALC
ASC/AE2	FR-SMF-150-ASC-AE2

[TIP]	FOCIS Flex Tips and Cleaning (PRO only)
Blank	Option not available in Basic & PLUS kits
SC	SC-UPC bulkhead tip, 2.5 mm UPC ferrule tip, 2.5 mm cleaning
FC	FC-UPC bulkhead tip, 2.5 mm UPC ferrule tip, 2.5 mm cleaning
LC	LC-UPC bulkhead tip, 1.25 mm UPC ferrule tip, 1.25 mm cleaning
ASC	SC-APC bulkhead tip, 2.5 mm APC ferrule tip, 2.5 mm cleaning
AFC	FC-APC bulkhead tip, 2.5 mm APC ferrule tip, 2.5 mm cleaning
ALC	LC-APC bulkhead tip, 1.25 mm APC ferrule tip, 1.25 mm cleaning

- Notes:**
- Results can be transferred from FlexScan OTDR to TRM® 3.0 using USB cable, or performed wirelessly (W1 option) after downloading free FlexScan App. The FlexScan App is available as a free download from 'Google play' or 'App Store'.
 - FlexScans equipped with Bluetooth option (W1) support Bluetooth transfer of results via FlexScan App for remote reporting using TRM 3.0.
 - Basic kit always ships with S2 (Medium Soft Case); MPO kit always ships with MPO-specific soft case.

FlexScan® FS200 Single-mode OTDR

Ordering Information

Accessories

DESCRIPTION	AFL NO.
FlexScan wrist strap	1400-05-0230PZ
FlexScan neck strap, 36"	1400-05-0231PZ
AC charger 100-240 VAC to 5 VDC	4050-00-0931PR
Soft carry case for FS200 kits with FOCIS Flex and Fiber Ring	1400-01-0111PZ
Soft carry case for FS200 kits with FOCIS Flex, OFI-BIPMe and Fiber Ring	1400-01-0128PZ
Hard carry case for FS200 kits with FOCIS Flex, OFI-BIPMe and Fiber Ring	1400-01-0134PZ
Vehicle charger, 12VDC to 5VDC @2A	4050-00-0033MR
Cable, USB-micro B, 5 pin, 6'	6000-00-0031MR
5V USB charging cable (1.5 m), type A to barrel (0.9 X 3.2 X 9 mm)	6000-00-0034PR
One-Clicks, fluid, wipes, etc. See www.AFLglobal.com	Cleaning Supplies

Field-Replaceable OTDR Connector (Optical Port Ferrule Saver)

Protect your OTDR ports from damage due to mating with dirty or damaged launch cables or patch cords or normal wear-and-tear. Equip your FlexScan FS200 with a field-replaceable connector, which installs in seconds and accepts AFL's tool-free interchangeable SC, LC, FC and ST connector adapters.

Replace damaged connectors in the field: When normal wear-and-tear or poor cleaning practices damage the port saver's end-face, replace it in seconds without having to return the OTDR to a service center for an expensive and time-consuming repair.

DESCRIPTION	AFL NO.
Field-replaceable connector; APC female to APC male	2900-58-0001MR
Field-replaceable connector; APC female to UPC male	2900-58-0002MR
Field-replaceable connector, UPC female to APC male	2900-58-0003MR
Field-replaceable connector; UPC female to UPC male	2900-58-0004MR

Connector Adapters

CONNECTOR ADAPTER	AFL NO.		
	OTDR/OLS PORT	OPM PORT	VFL PORT
FC	2900-50-0002MR	2900-52-0001MR	N/A
SC	2900-50-0003MR	2900-52-0002MR	N/A
ST	2900-50-0004MR	2900-52-0003MR	N/A
LC	2900-50-0006MR	2900-52-0004MR	N/A
SC/APC	2900-50-0011MR	N/A	N/A
2.5 mm Universal	N/A	2900-52-0005MR	2900-50-0007MR
1.25 mm Universal	N/A	2900-52-0006MR	2900-50-0010MR

FlexScan® FS200 Single-mode OTDR

Test Management and Reporting Software

DESCRIPTION	AFL NO.
TRM 3.0 with Basic License (OTDR Trace/OLTS Viewer, Batch Editor and Reports), USB delivery (included with all FS200 kits)	TRM3-BASIC
TRM 3.0 upgrade from Basic to Advanced License, USB delivery	TRM3-UPGRADE
TRM 3.0 upgrade from Basic to Advanced License, email delivery	TRM3-UP-EMAIL
FlexScan App (Android Google play)	Free Download

Recommended Products



FOCIS Flex and FOCIS Lightning (Multi-Fiber) Connector Inspection

- Self-contained, tether-free, hand-held inspection solution
- Auto-focus and auto-centering for fast, easy inspection
- IEC, IPC and user-defined pass/fail analysis
- FOCIS Lightning: extremely fast multi-fiber auto-analysis for datacom and telecom inspection applications



OFI-BIPMe Optical Fiber Identifier

- Works on all fiber types including BIF
- Trigger lock, positive stop for optimum detection
- Integrated optical power meter

Qualifications

CATEGORY	REGULATION/STANDARD	QUALIFICATION
CE Marking	EU	Compliant to relevant EU Directives on health, safety, and environmental protection, and certified with CE marking
Safety/EMC/EMI	IEC	Compliant to IEC 61010-1 for safety requirements for electrical equipment
	EN	Compliant to EN 61010-1 for safety requirements for electrical equipment
	IEC	Compliant to IEC 61326-1 for EMC requirements for electrical equipment
	EN	Compliant to EN 61326-1 for EMC requirements for electrical equipment
	EN	Compliant to EN 55011 for EMC requirements for industrial, scientific and medical equipment
	Telcordia	Compliant to GR-196-CORE 4.5.1 for requirements on electromagnetic interference
	FCC	Compliant to code of federal regulations FCC 47 CFR 15 on unlicensed transmissions
	FDA	Compliant to code of federal regulations FDA 21 CFR 1040.10 and 1040.11 on laser products
RoHS	IEC	Compliant to IEC 60825-1 for safety of laser products
	EU	Compliant to EU regulations Directive 2011/65/EU (RoHS 2) and Directive 2015/863 (RoHS 3)
Test Method	TIA	Compliant to TIA-568.3-D for test and measurement requirements for premises optical fiber cabling and components
	IEC	Compliant to IEC 11801 for test and measurement requirements for optical fiber cabling for use within premises
	AS/NZS	Compliant to AS/NZS 3080 for test and measurement requirements for optical fiber cabling for use within premises
	TIA	Compliant to TIA-526-7 for test procedures for installed optical fiber cable plant
	TIA	Compliant to TIA-526-14 for test procedures for installed optical fiber cable plant
	IEC	Compliant to IEC 14763-3 for systems and methods for the inspection and testing of installed optical fiber cabling
	AS/NZS	Compliant to AS/NZS 14763.3 for systems and methods for the inspection and testing of installed optical fiber cabling
	IEC	Compliant to IEC 61280-4-1 for test procedures for installed optical fiber cable plant
Generic Requirement	IEC	Compliant to IEC 61280-4-2 for test procedures for installed optical fiber cable plant
	Telcordia	Compliant to GR-196-CORE for generic requirements for OTDR-type equipment
	Telcordia	Compliant to SR-4731 Issue 2 for OTDR data format
	IEC	Compliant to IEC 61746-1 for requirements on calibration of OTDR

Contact Sales@AFLglobal.com to schedule a demonstration or learn how to buy.

Visit www.AFLglobal.com/Test to learn more about FlexScan FS200 OTDR.

International Sales and Service Contact Information available at www.AFLglobal.com/Test/Contacts

OTDR Fiber Rings



Features

- Compact, rugged, lightweight
- 150, 500, and 1000 m lengths standard
- Available with a variety of connector styles
- Compact! Fits easily in OTDR cases or kits

Applications

- Use to test link loss with an OTDR
- For use as OTDR launch cable
- For use as OTDR receive cable
- Measure insertion loss and reflectance of near- and far-end connections

Fiber Rings are often a necessity when testing with an OTDR or Optical Troubleshooter. A launch cable, which connects the OTDR or Optical Troubleshooter to the link under test, reveals the insertion loss and reflectance of the near-end connection. A receive cable, which connects to the far-end of the link, reveals the insertion loss and reflectance of the far-end connection. Launch and receive test cables can range from 150 m to 1 km (or longer) in length. Because very long test cables are impractical to transport and use, AFL offers coiled lengths of 50 μm multimode, 62.5 μm multimode, or single-mode fiber packaged in compact rings.

Fiber Rings of 150 m of fiber are ideal for premises fiber network test applications. Fiber Rings of 500 m and 1 km of single-mode fiber are designed for broadband, long haul fiber network test applications.

OTDR Fiber Rings

Fiber Rings Part Number Order Entry

Single Fiber (SM or MM) Fiber Rings

AFL NO. = FR-FFF-LLLL-CC1-CC2, where:

FR = Fiber Ring (single fiber)

FFF = Fiber Type

SMF= Single-mode (G.652)

BIF = Bend Insensitive (G.657)

OM1 = 62.5 μm multimode

OM2 = 50 μm multimode

OM3 = 50 μm laser optimized

OM4 = 50 μm laser optimized

LLLL = Fiber Length (meters)

150 = 150 m (492 ft)

500 = 500 m (1640 ft)

1000 = 1000 m (3280 ft)

CC1 = Connector Configuration OTDR end (see below)

CC2 = Connector Configuration Network end (see below)

MPO-terminated Multi-Fiber (SM or MM) Fiber Rings

AFL NO. = FRM1-FF-LLLL-P-MC1-MC2, where:

FRM1 = MPO-terminated 12-fiber fiber ring

FF = Fiber Type

S2 = Standard single-mode (G.652)

M4 = OM4 50 μm laser optimized

LLLL = Fiber Length (meters)

61 = 61 m (200 ft)

P = Polarity

A = Type A polarity (straight through, fiber 1 to fiber 1)

B = Type B polarity (fiber 1 to fiber 12)

MC1, MC2 = MPO Connector (OTDR end and Network end, respectively)

AF = APC, female (unpinned)

AM = APC, male (pinned)

UF = UPC, female (unpinned)

UM = UPC, male (pinned)

Supported Single Fiber Single-mode Fiber Ring Configurations

CONNECTOR TYPE		STANDARD SMF FIBER RINGS		SPECIAL ORDER SMF FIBER RINGS ^a	
ID	DESCRIPTION	CC1	CC2	CC1	CC2
USC	SC/UPC	◆	◆		
ASC	SC/APC	◆	◆		
ULC	LC/UPC		◆	◆	◆
ALC	LC/APC		◆	◆	◆
UFC	FC/UPC		◆	◆	◆
AFC	FC/APC		◆	◆	◆
UST	ST/UPC		◆	◆	◆
UE2	E2000/UPC		Special Order ^a		◆
AE2	E2000/APC		Special Order ^a		◆
OTA	OptiTap APC		Special Order ^a		
TRD	TRIDENT APC		Special Order ^a		

Supported Single Fiber Multimode Fiber Ring Configurations

CONNECTOR TYPE		STANDARD SMF FIBER RINGS		SPECIAL ORDER SMF FIBER RINGS ^a	
ID	DESCRIPTION	CC1	CC2	CC1	CC2
USC	SC/UPC	◆	◆		
ULC	LC/UPC		◆	◆	◆
UFC	FC/UPC		◆	◆	◆
UST	ST/UPC		◆	◆	◆
UE2	E2000/UPC		Special Order ^a		

OTDR Fiber Rings

Ordering Information

Standard SMF Fiber Rings

DESCRIPTION	AFL NO.
Fiber Ring, 150 m, G.652 SMF, CC1-CC2	FR-SMF-150-CC1-CC2
Fiber Ring, 500 m, G.652 SMF, CC1-CC2	FR-SMF-500-CC1-CC2
Fiber Ring, 1000 m, G.652 SMF, CC1-CC2	FR-SMF-1000-CC1-CC2

Special Order SMF Fiber Rings^a

DESCRIPTION	AFL NO.
Fiber Ring, 150 m, G.652 SMF, CC1-CC2	FR-SMF-150-CC1-CC2
Fiber Ring, 500 m, G.652 SMF, CC1-CC2	FR-SMF-500-CC1-CC2
Fiber Ring, 1000 m, G.652 SMF, CC1-CC2	FR-SMF-1000-CC1-CC2
Fiber Ring, 150 m, G.657.A2 BIF, CC1-CC2	FR-BIF-150-CC1-CC2
Fiber Ring, 500 m, G.657.A2 BIF, CC1-CC2	FR-BIF-500-CC1-CC2
Fiber Ring, 1000 m, G.657.A2 BIF, CC1-CC2	FR-BIF-1000-CC1-CC2

Standard OM1, OM2, OM3, OM4 Multimode Fiber Rings

DESCRIPTION	AFL NO.
Fiber Ring, 150 m, OM1 (62.5 mm) MMF, CC1-CC2	FR-OM1-150-CC1-CC2
Fiber Ring, 150 m, OM2 (50 mm) MMF, CC1-CC2	FR-OM2-150-CC1-CC2
Fiber Ring, 150 m, OM3 (50 mm laser-optimized) MMF, CC1-CC2	FR-OM3-150-CC1-CC2
Fiber Ring, 150 m, OM4 (50 mm laser-optimized) MMF, CC1-CC2	FR-OM4-150-CC1-CC2

Special Order OM1, OM2, OM3, OM4 Multimode Fiber Rings^a

DESCRIPTION	AFL NO.
Fiber Ring, 150 m, OM1 (62.5 mm) MMF, CC1-CC2	FR-OM1-150-CC1-CC2
Fiber Ring, 150 m, OM2 (50 mm) MMF, CC1-CC2	FR-OM2-150-CC1-CC2
Fiber Ring, 150 m, OM3 (50 mm laser-optimized) MMF, CC1-CC2	FR-OM3-150-CC1-CC2
Fiber Ring, 150 m, OM4 (50 mm laser-optimized) MMF, CC1-CC2	FR-OM4-150-CC1-CC2

Standard MPO-terminated Multi-fiber Single-mode and Multimode Fiber Rings^b

DESCRIPTION	AFL NO.
MPO Fiber Ring, 61 m (200 ft), G.652 SMF, Type A, APC unpinned to APC unpinned	FRM1-S2-61-A-AF-AF
MPO Fiber Ring, 61 m (200 ft), G.652 SMF, Type A, APC unpinned to APC pinned	FRM1-S2-61-A-AF-AM
MPO Fiber Ring, 61 m (200 ft), OM4 MMF, Type A, UPC unpinned to UPC unpinned	FRM1-M4-61-A-UF-UF
MPO Fiber Ring, 61 m (200 ft), OM4 MMF, Type A, UPC unpinned to UPC pinned	FRM1-M4-61-A-UF-UM

Notes:

- a. Contact AFL for special order fiber rings. Not all combinations of lengths and connectors are supported.
- b. Contact AFL for other special order configurations of MPO-terminated multi-fiber single-mode or multimode fiber rings.

OTDR Fiber Rings

How to Generate a Baseline Trace Using Fiber Rings

- Use the Fiber Ring as a launch cable. Connect the Fiber Ring between your OTDR and the fiber link under test. This will allow you to measure the loss of the near-end connection.
- Use the Fiber Ring as a receive cable. Connect the Fiber Ring to the far-end connector of your fiber link under test. This will allow you to measure the loss of the far-end connection.
- By using Fiber Rings as both launch and receive cables, as shown in the diagram below, you can measure total insertion loss of the fiber link under test under test.

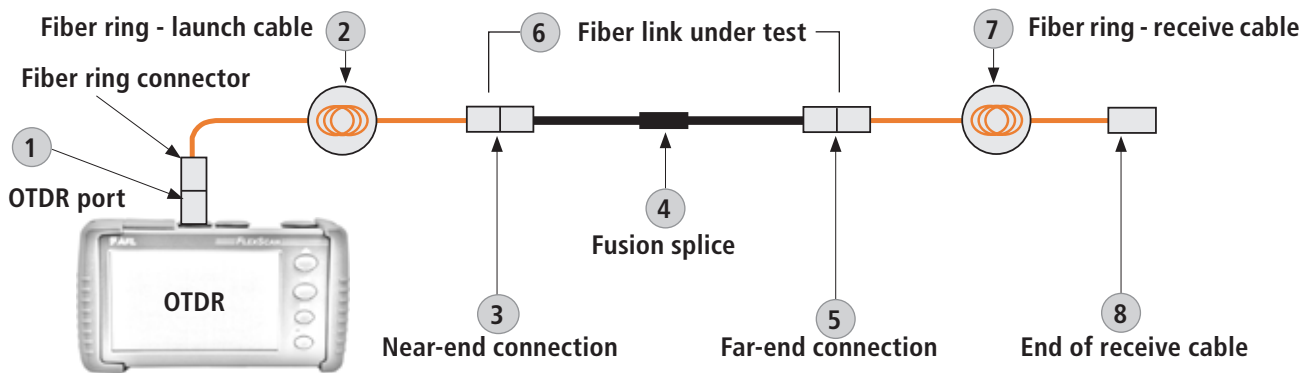

Example OTDR Test Configuration with Launch and Receive Cables

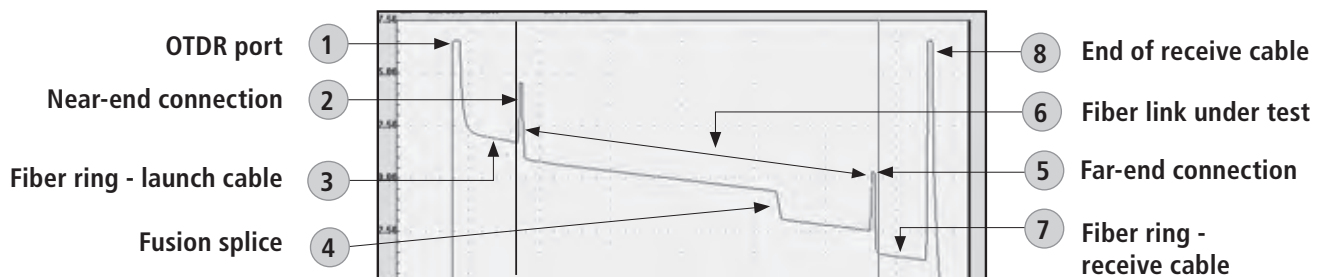

OTDR Trace Made using Launch and Receive Cables

Recommended Products



FlexScan® FS300 (quad) and FS200 (single-mode) OTDRs

- SmartAuto® 1-button automated testing for fast results
- LinkMap® color-coded icons for easy troubleshooting
- FleXpress® mode (FS200) completes OTDR test in <5 seconds!
- Integrated Source, Power Meter and VFL



FlexScan® TS100 FTTH PON Troubleshooter

- Locate faults in <3 seconds with the press of a button
- Displays link length, loss, ORL, and pass/fail results
- Single-ended test reduces time and cost
- Rugged, lightweight, hand-held for field use

Contact Sales@AFLglobal.com to schedule a demonstration or learn how to buy.

Visit www.AFLglobal.com/Test to learn more about Fiber Rings.

International Sales and Service Contact Information available at www.AFLglobal.com/Test/Contacts

OPM5 and OPM4 Optical Power Meters



OPM5 Optical Power Meter

Features

- Rugged, dependable, and backed by industry-best 5-year warranty
- Wave ID tests up to three wavelengths simultaneously - slashing test time
- Field-swappable connector adapters for maximum flexibility
- Long battery life from globally available AA batteries

Applications

- Passive Optical Networks (PON) testing
- OPM(5/4)-4D (Filtered-InGaAs) for high power (+26 dBm) CATV broadband networks or DWDM system applications
- OPM(5/4)-3D (InGaAs) for telecommunications networks
- OPM(5/4)-2D (Ge) for premises LAN/WAN multimode or single-mode networks
- OPM4-1D (Silicon) for multimode/plastic optical fiber applications

AFL is a trusted supplier of optical testing equipment with more than 30 years of experience and tens of thousands of units in use in the field. AFL's full range of power meters are used for testing single-mode and/or multimode fiber networks. Power meters with wave ID can detect two or more wavelengths simultaneously – decreasing test time and reducing user errors when paired with AFL wave ID light sources.

Designed for the real world: AFL's power meters are designed to meet the demands of the outside plant environment. They withstand the one-meter drop test and have splash resistant controls that are easy to use, even with gloves on.

Flexible and efficient: A range of field-swappable output adapters enables access for cleaning optical ports and supports multiple connector styles. The efficient design provides long test time from globally available AA batteries. Equipped with five-minute auto-off feature to save power.

Reduce test time and errors: Wave ID (Triple, Dual, or Single) decreases test time while reducing technician errors.

Stores test results: AFL's OPM5 stores optical reference at each calibrated wavelength. This enables technicians to organize test results into multiple files and transfer stored results via USB to the included PC-based TRM® 2.0 software for analyzing, generating reports, and printing. Users can generate network Pass/Fail results demonstrating compliance to industry standards and illustrate headroom. Fully N.I.S.T. traceable.

OPM5 and OPM4 Optical Power Meters

Specifications ^a

OPTICAL				
MODEL	OPM5-4D, OPM4-4D	OPM5-3D, OPM4-3D	OPM5-2D, OPM4-2D	OPM4-1D
Calibrated Wavelengths	850, 980, 1300, 1310, 1490, 1550, 1625 nm	850, 1300, 1310, 1490, 1550, 1625 nm	850, 1300, 1310, 1490, 1550 nm	650, 660, 780, 850 nm
Detector Type	Filtered InGaAs	InGaAs	Germanium (Ge)	Silicon (Si)
Measurement Range	+26 to -50 dBm	+10 to -75 dBm	+6 to -60 dBm	+6 to -70 dBm
Tone Detect Range	+6 to -30 dBm +6 to -25 dBm for 850 nm	+10 to -50 dBm +10 to -45 dBm for 850 nm	+6 to -50 dBm +6 to -45 dBm for 850 nm	+6 to -45 dBm
Wavelength ID Range	+6 to -30 dBm +6 to -25 dBm for 850 nm	+10 to -50 dBm +10 to -45 dBm for 850 nm	+6 to -50 dBm +6 to -45 dBm for 850 nm	—
Accuracy ^b	±0.1 dB (typical); ±0.25 dB			
Resolution	0.01 dB			
Measurement Units	dB, dBm, µW			

GENERAL	
Power	2 x AA batteries, accepts standard mini-USB power adapter
Adapter Caps	Order with one: 1.25 mm Universal, 2.5 mm Universal, FC, SC, ST, LC. Other connector adapters available
Battery Life	300 hours
Operating Temperature	-10 °C to 50 °C, 95 % RH (non-condensing)
Storage Temperature	-30 °C to 60 °C, 95 % RH (non-condensing)
Size (H x W x D)	14.0 x 8.1 x 3.8 cm (5.5 x 3.2 x 1.5 in)
Weight	0.26 kg (0.58 lb)

Notes:

- a. All specifications valid at 25°C unless otherwise specified.
- b. Accuracy measured at 25 °C and -10 dBm per N.I.S.T. standards.

Ordering Information

All OPM models include optical power meter, 2 AA batteries, protective rubber boot, customer specified adapter cap, and carry case. OPM5 models also include TRM[®] 2.0 software (Basic License).

When placing an order, select options as follows:

- Model Number (M)
- Detector Type (N)
- Connector Configuration (CC)

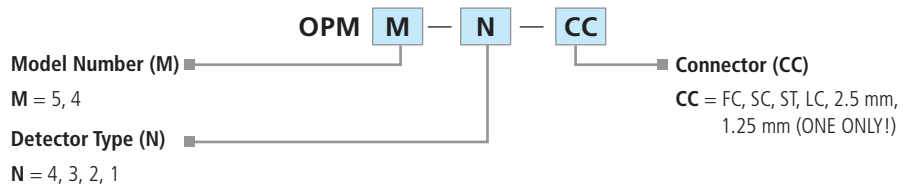

MODEL	CALIBRATED WAVELENGTHS (nm)										DETECTOR TYPE	MEASUREMENT RANGE (dBm)	PC SOFTWARE
	650	660	780	850	980	1300	1310	1490	1550	1625			
OPM5-4D				◆	◆		◆	◆	◆	◆	InGaAs	+26 to -50	TRM 2.0
OPM5-3D				◆		◆	◆	◆	◆	◆	InGaAs	+10 to -75	TRM 2.0
OPM5-2D				◆		◆	◆	◆	◆		Germanium	+6 to -60	TRM 2.0
OPM4-4D				◆	◆		◆	◆	◆	◆	InGaAs	+26 to -50	
OPM4-3D				◆		◆	◆	◆	◆	◆	InGaAs	+10 to -75	
OPM4-2D				◆		◆	◆	◆	◆		Germanium	+6 to -60	
OPM4-1D	◆	◆	◆	◆							Silicon	+6 to -70	

OPM5 and OPM4 Optical Power Meters

OPM Accessories

DESCRIPTION	AFL NO.		
ADAPTER CAPS			
2.5 mm Universal (accepts FC, SC, and ST ferrules)	8800-00-0214		
1.25 mm Universal (accepts LC and MU ferrules)	8800-00-0224		
FC	8800-00-0200		
SC	8800-00-0209		
ST®	8800-00-0202		
LC simplex	8800-00-0225		
E-2000	8800-00-0221		
2.5 mm open Universal. Accepts SC duplex, OptiTap connector for measuring optical power.	8800-00-0219		
SMA	8800-00-0203		
D4	8800-00-0201		
Biconic	8800-00-0204		
USB CABLE			
USB Cable: PC (USB-A) to OPM (USB-MINI B):	OPM5 MODEL	OPM4 MODEL	6000-00-0024MR
<ul style="list-style-type: none"> • Connect OPM to PC for data upload to TRM® 2.0 • External Power for OPM (when used with customer supplied USB-A power source) 	Connect to PC and External power	External power only	

Test Management and Reporting Software

DESCRIPTION	AFL NO.
TRM® 2.0 with Basic License (OTDR Trace/OLTS Viewer, Batch Editor and Reports), USB delivery	TRM-00-0900PR

OPM5 and OPM4 Optical Power Meters

Recommended Products



FlexScan® FS300 (quad) and FS200 (single-mode) OTDRs

- SmartAuto® 1-button automated testing for fast results
- LinkMap® color-coded icons for easy troubleshooting
- FleXpress® mode (FS200) completes OTDR test in <5 seconds!
- Integrated Source, Power Meter and VFL



Optical Light Sources

- Encircled Flux Compliant
- 5-Year Product Warranty
- Integrated LED and Laser light sources

Qualifications

CATEGORY	REGULATION/STANDARD	QUALIFICATION
CE Marking	EU	Compliant to relevant EU Directives on health, safety, and environmental protection, and certified with CE marking
Safety/EMC/EMI	IEC	Compliant to IEC 61010-1 for safety requirements for electrical equipment
	EN	Compliant to EN 61010-1 for safety requirements for electrical equipment
	IEC	Compliant to IEC 61326-1 for EMC requirements for electrical equipment
	EN	Compliant to EN 61326-1 for EMC requirements for electrical equipment
	EN	Compliant to EN 55011 for EMC requirements for industrial, scientific and medical equipment
RoHS	EU	Compliant to EU regulations Directive 2011/65/EU (RoHS 2) and Directive 2015/863 (RoHS 3)
Test Method	TIA	Compliant to TIA-568.3-D for test and measurement requirements for premises optical fiber cabling and components
	IEC	Compliant to IEC 11801 for test and measurement requirements for optical fiber cabling for use within premises
	EN	Compliant to EN 50173 for test and measurement requirements for optical fiber cabling for use within premises
	AS/NZS	Compliant to AS/NZS 3080 for test and measurement requirements for optical fiber cabling for use within premises
	TIA	Compliant to TIA-526-7 for test procedures for installed optical fiber cable plant
	TIA	Compliant to TIA-526-14 for test procedures for installed optical fiber cable plant
	IEC	Compliant to IEC 14763-3 for systems and methods for the inspection and testing of installed optical fiber cabling
	AS/NZS	Compliant to AS/NZS 14763.3 for systems and methods for the inspection and testing of installed optical fiber cabling
	IEC	Compliant to IEC 61280-4-1 for test procedures for installed optical fiber cable plant
	IEC	Compliant to IEC 61280-4-2 for test procedures for installed optical fiber cable plant
Generic Requirement	IEC	Compliant to IEC 61315 for requirements on calibration of fibre-optic power meters

Contact Sales@AFLglobal.com to schedule a demonstration or learn how to buy.

Visit www.AFLglobal.com/Test to learn more about OPM5 and OPM4 optical power meters.

International Sales and Service Contact Information available at www.AFLglobal.com/Test/Contacts

Optical Loss Test Kits



SMLP5-5 Kit

Features

- Rugged, dependable, and backed by industry-best 5-year warranty
- Wave ID tests up to three wavelengths simultaneously - slashing test time
- Field-swappable connector adapters for maximum flexibility
- Long battery life from globally available AA batteries

Applications

- Certify multimode and single-mode links per TIA/EIA standards
- Passive Optical Networks (PON) testing
- Certification report generation with TRM® 2.0 software
- Fiber identification for splicing and continuity checking

Optical Loss Test Sets (OLTS) provide the most accurate method for determining the total loss of a link. AFL’s OLTS have been an industry favorite for over 30 years with more than 100,000 units shipped. Leading service providers and enterprise customers rely on AFL’s OLTS for their ruggedness, reliability, and best-in-the-industry 5-year warranty.

An OLTS test is performed with a light source on one end of the fiber sending a continuous wave at specific wavelength(s) and a power meter on the opposite end measuring the light received. The loss measured is compared to the loss budget, which is usually calculated prior to installation, and reflects the industry standards used to ensure that the link can meet its application requirements.

OLTS are mainly used to certify multimode and single-mode links, test Passive Optical Networks (PONs), identify fibers before splicing, and to ensure network continuity.

Designed for use in outside plant environments: AFL OLTS are extremely rugged and withstand one-meter drops, have splash resistant controls that are easy to use with gloves on, and the field-swappable connector adapters provide flexibility and access for cleaning optical ports at time of test.

Test faster with fewer errors: AFL’s Wave ID increases test speed by performing simultaneous multi-wavelength testing that cuts loss measurement time in half or more. AFL’s automatic wavelength identification eliminates setup errors and simplifies coordination between users at opposite ends of fiber.

Optical Loss Test Kits

Specifications^a

OPTICAL SPECIFICATIONS - POWER METERS			
MODEL	OPM5-4D	OPM5-3D, OPM4-3D	OPM5-2D
Calibrated Wavelengths	850, 980, 1300, 1310, 1490, 1550, 1625 nm	850, 1300, 1310, 1490, 1550, 1625 nm	850, 1300, 1310, 1490, 1550 nm
Detector Type	Filtered InGaAs	InGaAs	Germanium (Ge)
Measurement Range	+26 to -50 dBm	+10 to -75 dBm	+6 to -60 dBm
Tone Detect Range	+6 to -30 dBm +6 to -25 dBm for 850 nm	+10 to -50 dBm +10 to -45 dBm for 850 nm	+6 to -50 dBm +6 to -45 dBm for 850 nm
Wavelength ID Range	+6 to -30 dBm +6 to -25 dBm for 850 nm	+10 to -50 dBm +10 to -45 dBm for 850 nm	+6 to -50 dBm +6 to -45 dBm for 850 nm
Accuracy	±0.1 dB (typical); ±0.25 dB		
Resolution	0.01 dB		
Measurement Units	dB, dBm, µW		

OPTICAL SPECIFICATIONS: OLS7 MODELS			
MODEL	OLS7-FTTH (Single Port)		
Wavelength (±20 nm)	1310 nm	1490 nm	1550 nm
Spectral Width	5 nm	3 nm	5 nm
Emitter Type	Laser		
Safety Class	Class I FDA 21 CFR 1040.10 and 1040.11, IEC 60825-1: 2007-03		
Output Power	-5 dBm (typical), 9/125 fiber		
Output Stability	±0.05 dB over 1 hour (after 15 minutes warm-up) ±0.1 dB over 8 hours (after 15 minutes warm-up)		
Tone Output	270 Hz, 330 Hz, 1 kHz, 2 kHz		

OPTICAL SPECIFICATIONS: OLS4, OLS2-DUAL & OLS1-DUAL MODELS						
MODEL	OLS4 (MM Optical Port)		OLS4 (SM Optical Port)		OLS2-DUAL (Single Port)	
Wavelength	850 ±30 nm	1300 +30/-20 nm	1310 ±20 nm	1550 ±20 nm	1310 ±20 nm	1550 ±20 nm
Spectral Width	45 nm (typ)	120 nm (typ)	5 nm (max)	5 nm (max)	5 nm (max)	
Emitter Type	LED		Laser		Laser	
Safety Class	Class I FDA 21 CFR 1040.10 and 1040.11, IEC 60825-1: 2007-03					
Output Power	>-20 dBm, 62.5 µm multimode ^b		0 dBm, 9 µm single-mode		0 dBm, 9 µm single-mode ^c	
Output Stability	±0.1 dB over 8 hours (after 5 minutes warm-up)		±0.05 dB over 1 hour (after 15 minutes warm-up) ±0.1 dB over 8 hours (after 15 minutes warm-up)			
Tone Output	N/A		2 kHz		270 Hz, 330 Hz, 1 kHz, 2 kHz	

GENERAL SPECIFICATIONS: ALL OPM AND OLS MODELS	
Available Adapters	SC FC, ST, LC
Power	2 AA batteries
Operating Temperature	-10 °C to 50 °C, 90 % RH (non-condensing)
Storage Temperature	-30 °C to 60 °C, 90 % RH (non-condensing)
Size (H x W x D)	14.0 x 8.1 x 3.8 cm (5.5 x 3.2 x 1.5 in)
Weight	0.29 kg (0.65 lb)

Notes:

- All specifications valid at 25°C unless otherwise specified.
- May be used to test 50 or 62.5 µm fiber with supplied mandrels.
- Output power will be approximately 3 dB less if a 50 µm mandrel-wrapped jumper is used instead of a 62.5 µm mandrel-wrapped jumper.
- Adjustable 2 dB.

Optical Loss Test Kits

Ordering Information

Test kits include light source, power meter, protective rubber boots, AA batteries, adapter caps, and carry case.

AFL NO.	POWER METER	LIGHT SOURCE	FIBER TYPE	LOSS MEASUREMENTS (nm)					DYNAMIC RANGE (dB)	TRM® 2.0 PC REPORTING
				850	1300	1310	1490	1550		
SLP5-6	OPM5-3D	OLS2-DUAL	SM			◆		◆	70 ^b	◆
SLP5-FTTH	OPM5-4D	OLS7-FTTH	SM			◆	◆	◆	45 ^b	◆
SMLP5-5	OPM5-2D	OLS4	MM SM	◆	◆	◆		◆	40 @ 850/1300 nm ^a 60 @ 1310/1550 nm ^b	◆

Notes:

- a. On 62.5/125 µm multimode fiber.
- b. On 9/125 µm single-mode fiber.

Part Number – Connector Specification

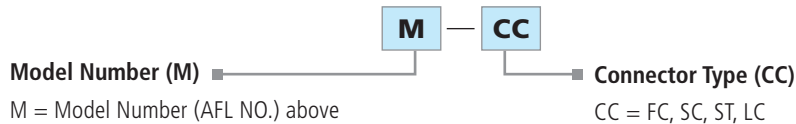

Examples: SMLP5-5-SC => (SMLP5-5 Test Kit with SC adapters)

Accessories

DESCRIPTION	AFL NO.
LIGHT SOURCE CONNECTOR ADAPTERS	
FC connector adapter	2900-50-0002MR
SC connector adapter	2900-50-0003MR
ST connector adapter	2900-50-0004MR
LC connector adapter	2900-50-0006MR
POWER METER CONNECTOR ADAPTERS	
FC connector adapter	8800-00-0200
SC connector adapter	8800-00-0209
ST connector adapter	8800-00-0202
LC connector adapter	8800-00-0225
ENCIRCLED FLUX (EF) MODE CONTROLLER	
FC to FC, 50/125 µm	8700-06-0001MR
FC to FC, 2.5/125 µm	8700-06-0002MR
SC to SC, 50/125 µm	8700-06-0003MR
SC to SC, 62.5/125 µm	8700-06-0004MR
SC to LC, 50/125 µm	8700-06-0005MR
SC to LC, 62.5/125 µm	8700-06-0006MR
MULTIMODE TEST CORDS (50/125 µm – 2 meters)	
FC/FC	8700-00-0093
SC/ST	8700-00-0064
SC/SC	8700-00-0065
LC/LC	8700-00-0082

DESCRIPTION	AFL NO.
SINGLE-MODE TEST CORDS (9/125 µm – 2 meters)	
FC/FC	8700-00-0005
FC/ST	8700-00-0016
ST/ST	8700-00-0017
SC/SC	8700-00-0018
FC/SC	8700-00-0021
SC/ST	8700-00-0022
SC/LC	8700-00-0046
FC/LC	8700-00-0071
LC/LC	8700-00-0097
MATING ADAPTERS (Bulkheads)	
FC/FC	8400-00-0004MR
SC/SC	8400-00-0045MR
ST/ST	8400-00-0020
LC/LC	8400-00-0075
CLEANING SUPPLIES	
One-Click Cleaner SC/ST/FC	8500-05-0001MZ
One-Click Cleaner LC	8500-05-0002MZ
Cletop –SB Cassette Cleaner	8500-10-0016MZ
Cletop –SB Refill Cartridge	8500-10-00017MZ

Optical Loss Test Kits

Test Management and Reporting Software

DESCRIPTION	AFL NO.
TRM® 2.0 with Basic License (OTDR Trace/OLTS Viewer, Batch Editor and Reports), USB delivery	TRM-00-0900PR

Recommended Products



OFI-BIPM Optical Fiber Identifier

- World class signal sensitivity
- Trigger lock, positive stop for optimum detection
- Integrated optical power meter option



One-Click® Cleaners

- Patented single-action
- Variety of sizes and types
- Low cost per clean

Qualifications

CATEGORY	REGULATION/STANDARD	QUALIFICATION
CE Marking	EU	Compliant to relevant EU Directives on health, safety, and environmental protection, and certified with CE marking
Safety/EMC/EMI	IEC	Compliant to IEC 61010-1 for safety requirements for electrical equipment
	EN	Compliant to EN 61010-1 for safety requirements for electrical equipment
	IEC	Compliant to IEC 61326-1 for EMC requirements for electrical equipment
	EN	Compliant to EN 61326-1 for EMC requirements for electrical equipment
	EN	Compliant to EN 55011 for EMC requirements for industrial, scientific and medical equipment
	FDA	Compliant to code of federal regulations FDA 21 CFR 1040.10 and 1040.11 on laser products
RoHS	IEC	Compliant to IEC 60825-1 for safety of laser products
	EU	Compliant to EU regulations Directive 2011/65/EU (RoHS 2) and Directive 2015/863 (RoHS 3)
Test Method	TIA	Compliant to TIA-568.3-D for test and measurement requirements for premises optical fiber cabling and components*
	IEC	Compliant to IEC 11801 for test and measurement requirements for optical fiber cabling for use within premises*
	EN	Compliant to EN 50173 for test and measurement requirements for optical fiber cabling for use within premises*
	AS/NZS	Compliant to AS/NZS 3080 for test and measurement requirements for optical fiber cabling for use within premises*
	TIA	Compliant to TIA-526-7 for test procedures for installed optical fiber cable plant
	TIA	Compliant to TIA-526-14 for test procedures for installed optical fiber cable plant*
	IEC	Compliant to IEC 14763-3 for systems and methods for the inspection and testing of installed optical fiber cabling*
	AS/NZS	Compliant to AS/NZS 14763.3 for systems and methods for the inspection and testing of installed optical fiber cabling*
	IEC	Compliant to IEC 61280-4-1 for test procedures for installed optical fiber cable plant*
IEC	Compliant to IEC 61280-4-2 for test procedures for installed optical fiber cable plant	
Generic Requirement	IEC	Compliant to IEC 61315 for requirements on calibration of fibre-optic power meters

* A complementary encircled flux mode conditioner may be needed to comply with encircled flux launch conditions for testing multimode optical fiber cabling and components

Contact Sales@AFLglobal.com to schedule a demonstration or learn how to buy.

Visit www.AFLglobal.com/Test to learn more about OLTS kits.

International Sales and Service Contact Information available at www.AFLglobal.com/Test/Contacts

VFI4 Visual Fault Identifier



Features

- Eye-safe Class 3R visible red laser source, 650 nm
- Output power of 5.0 mW with 10 km range
- Universal connector interface for quick connection
- 2.5 mm universal adapter (included) accepts FC, SC, ST, etc. connectors
- 1.25 mm universal adapter (included) accepts LC and MU connectors

Applications

- Identify and trace fibers during activation and installation
- Identify poorly mated connectors
- Verify AFL’s FASTConnect® field-installable connector installation
- Find faults inside OTDR dead zones

ADAPTER, 2.5MM, VFI4, ZIRCONIA SLEEVE, SPLIT, ROHS
ADAPTER, 1.25MM, VFI4, ZIRCONIA SLEEVE, SPLIT, ROHS

A Visible Fault Identifier (VFI), also referred to as a Visual Fault Locator (VFL), is an essential tool for fiber installation and maintenance technicians.

AFL’s compact VFI4 injects high-powered red-laser light to provide exceptional brightness and range for locating defects in single-mode and multimode fibers. The light generated by these units will escape from sharp bends and breaks in jacketed or bare fibers, as well as poorly mated connectors enabling technicians to quickly spot faults. The universal connector interface mates with many connector styles without needing an adapter.

Rugged and Compact: The rugged VFI4 is designed for the rigors of real-life field testing. It has a range of up to 10 km, fits on a keychain, and features extensions that protect the red-laser port. It has both CW and pulsating modes and is powered by a single AA battery for up to 30 hours of operation.

Installation and Activation: VFI4 is used for quick continuity checks, fiber tracing, splice verification, and Pass/Fail validation for mechanical connectors. VFI4 is also an excellent complement to any OTDR because it can locate faults inside the OTDR’s dead zone.

Essential Troubleshooting Tool: The VFI4 highlights sharp bends, breaks, faulty connectors, and other defects that “leak” light. Other applications include end-to-end continuity checks, as well as identifying connectors in patch panels and fibers during splicing operations.

VFI4 Visual Fault Identifier

Specifications^a

OPTICAL	
Emitter Type	Laser, Class IIIa FDA 21 CFR 1040.10 and 1040.11, Class 3R IEC 60825-1:2014
Wavelength	650 nm ±15 nm
Output Power	5 mW maximum
Modulation	2 Hz or CW selected

GENERAL	
Adapter	2.5 mm Universal, 1.25 mm Universal
Power	1 AA battery, <30 hours (Flash mode)
Operating Temperature	-10°C to 50°C, 85 % humidity non condensing
Storage Temperature	-30°C to 60°C, 95 % humidity non condensing
Size (H x W x D)	7.9 x 5.1 x 2.2 cm (3.1 x 2.0 x 0.9 in)
Weight	43 g (1.5 oz)

Notes:

a. All specifications valid at 25°C unless otherwise specified.

Ordering Information

DESCRIPTION	AFL NO.
VFI4 visual fault identifier with 2.5 mm and 1.25 mm adapters	VFI4-01-0900PR

Adapters

DESCRIPTION	AFL NO.
2.5 mm Universal for VFI port	2900-50-0013MR
1.25 mm Universal for VFI port	2900-50-0012MR

Recommended Products



One-Click® Cleaner Mini

- Small compact design with single action cleaning
- Automatically advance ensures each clean is performed with fresh cleaning tape
- 100 clean and 500 clean versions available
- Low cost per clean



FASTConnect® Field-Installable Connectors

- Field-installable, takes less than a minute to complete
- Fast and easy to terminate
- Low insertion/return loss
- Reusable

Qualifications

CATEGORY	REGULATION/STANDARD	QUALIFICATION
CE Marking	EU	Compliant to relevant EU Directives on health, safety, and environmental protection, and certified with CE marking
Safety/EMC/EMI	IEC	Compliant to IEC 61010-1 for safety requirements for electrical equipment
	EN	Compliant to EN 61010-1 for safety requirements for electrical equipment
	IEC	Compliant to IEC 61326-1 for EMC requirements for electrical equipment
	EN	Compliant to EN 61326-1 for EMC requirements for electrical equipment
	EN	Compliant to EN 55011 for EMC requirements for industrial, scientific and medical equipment
	FDA	Compliant to code of federal regulations FDA 21 CFR 1040.10 and 1040.11 on laser products
RoHS	IEC	Compliant to IEC 60825-1 for safety of laser products
	EU	Compliant to EU regulations Directive 2011/65/EU (RoHS 2) and Directive 2015/863 (RoHS 3)

Contact Sales@AFLglobal.com to schedule a demonstration or learn how to buy.

Visit www.AFLglobal.com/Test to learn more about VFI4 Visual Fault Identifier.

International Sales and Service Contact Information available at www.AFLglobal.com/Test/Contacts.

FOCIS Lightning® Multi-Fiber Optic Connector Inspection System



Features

- Self-contained, tether-free, compact, hand-held inspection solution
- Auto-focus and auto-centering for fast, easy inspection
- Stores 10k images or easily shares data via USB or optional WiFi connectivity
- IEC, IPC, AT&T, and user-defined auto-analysis
- Wide variety of adapter tips for MPO and single-fiber connector types

Applications

- Inspect multi-fiber and single-fiber connectors and adapters
- Data center optical network installation, turn-up, and troubleshooting
- Verification proper connector cleaning practices
- Pairs with OTDR for comprehensive reporting

FOCIS Lightning is a compact self-contained inspection probe that captures and displays the entire MPO end-face image in less than two seconds. One button provides auto-focusing, centering, and pass/fail analysis at the connector and individual fiber level. It can complete a 24-fiber MPO inspection task in less than 15 seconds. Results can be easily shared via USB, WiFi, and Bluetooth®.

Pass/Fail results in seconds: FOCIS Lightning was designed to quickly inspect multi-fiber connectors and bulkheads, such as MPO and MTP®, including multi-row varieties. It can perform industry standard and user-defined end-face cleanliness analysis at a rate of about 1 second per fiber - the fastest in the Industry.

Internal storage and multiple export options: FOCIS Lightning can store 10,000 connector level and individual fiber images, analysis, overlays, and zones tables locally and provides optional WiFi and Bluetooth wireless links for archiving and reporting. The AFL FOCIS App (iOS and Android) provides a comprehensive and user-friendly feature set as well as connectivity with AFL's cloud-based aeRos® workflow automation platform.

Untethered operation: With rechargeable battery and integrated 2.4" TFT color LCD screen, FOCIS Lightning can be used independently.

Multi-fiber front-end adapter tips: Multi-fiber front-end adapter tips support single row and multi-row MT connector inspection for a wide range of patch cords and bulkhead-mounted connectors having either PC/UPC or APC polished end-faces. The probe snout includes a key which in combination with a slot on the adapter tips ensures that adapter tips never loosen during use, under any circumstances.

FOCIS Lightning® Multi-Fiber Optic Connector Inspection System

Specifications^a

OPTICAL PORT PARAMETERS	SPECIFICATION
Field of View (FOV; viewed on FOCIS Lightning)	Multi-fibers Live: 1960 x 4670 µm and 980 x 2335 µm Multi-fibers Captured, Overview: 1960 x 4338 µm Multi-fibers Captured, Details: 130 x 130 µm Single fiber Live: 890 x 1075 µm and 445 x 537 µm Single fiber Captured Zoomed Out: 684 x 742 µm Single fiber Captured, Partially Zoomed In: 456 x 492 µm Single fiber Captured, Fully Zoomed In: 228 x 246 µm
Field of View (FOV; viewed on a PC)	Multi-fibers Captured, Overview: 1960 x 4670 µm Multi-fibers Captured, Details: 130 x 130 µm Single fiber Captured, Zoomed Out: 525 x 700 µm Single fiber Captured, Partially Zoomed In: 355 x 475 µm Single fiber Captured, Zoomed In: 175 x 235 µm
Manual Detection Capability (minimum)	0.25 µm
Auto Analysis Resolution	<1.0 µm
Internally Stored Image Size (pixels)	Multi-fibers: 640 x 480 VGA; images stored internally in N+1 .JPG files, one in Overview screen and N each in Fiber Details screen Single fiber: 640 x 480 VGA; images stored internally in three .JPG files, one at each FOV
Bluetooth Image and Overlay	2 x QVGA (320 x 240; image + overlay) to AFL test instruments (SPP) 1 x VGA (640 x 480) file to Apple iOS devices (IAP / MFi)
Maximum No Damage Live Fiber Power Level	+20 dBm; image cannot be viewed if fiber is live
Focus Methods and Speeds	Auto-focus (≤3 sec) and manual focus
Centering	Auto-centering (<1 sec)
Zoom in Live Mode	1x and 2x modes
Image Capture with Pass/Fail Analysis	IEC 61300-3-35 (2015), AT&T TP-76461, IPC-8497-1, user-set criteria Capture SF <1 sec, MF <2 sec; Analysis <0.15 sec per fiber
Results Storage (Image and Pass/Fail Results)	Yes
File Format	JPG, GIF
File Storage Capacity	10,000 files
OPERATING FEATURES	
WiFi Characteristics (Wireless Models Only!)	IEEE 802.11 bng
Bluetooth Characteristics (Wireless Models Only!)	IAP (iPod accessory protocol), SPP 0 x 1101
USB Characteristics	USB 2.0 mass storage device
Supported Languages	English, Chinese Simplified, Chinese Traditional, Finnish, French, German, Italian, Japanese, Korean, Polish, Russian, Spanish, Turkish
ENVIRONMENT PARAMETERS	
Storage Temperature	-40 °C to +70 °C
Operating Temperature	0 °C to +50 °C
Relative Humidity	0 to 95% RH
Vibration Limits	2G (transportation)
Transit Drop (without soft case)	300 mm (12 inches, all sides, dust cover installed)
Transit Drop (with soft case)	460 mm (18 inches, all sides, dust cover installed)

Notes:

- All specifications valid at 23°C ±2°C (73.4°F ±3.6°F).
- Operating conditions: 60 tests in 20 minutes, then auto-off; repeat each hour.
- Trademarks are the property of their respective owners.

FOCIS Lightning® Multi-Fiber Optic Connector Inspection System

Specifications^a

PHYSICAL AND POWER CHARACTERISTICS	
Display Size, Type, Resolution	2.4", color TFT, backlit, 240 x 320 with brightness control
Battery Type	NiMH, user replaceable
Operating Time (typical)	6 hours ^b ; 3 hours continuous
Power Save Features	Auto-off (disabled, 2, 5, 10 min)
Recharge Time	≤4 hours
Low-Battery Warning	Alerts when ≤15 minutes battery operation remains
AC Charger Voltage, Frequency, Current	100-240VAC, 50/60Hz, 5VDC, 2A
Charger Jack	3.2 mm, center positive
Size	47 x 37 x 190 mm (1.8 x 1.5 x 7.7 in)
Weight	280 g (0.62 lb)
Safety & Compliance Certifications	UL, CE, FCC

Ordering Information

DESCRIPTION	AFL NO.
FOCIS Lightning Kit, soft carry case, AC charger, with no tips or One-Click® cleaner	FOCIS-LTNG-N
FOCIS Lightning Kit, soft carry case, AC charger, (1) UPC ferrule and bulkhead adapter tip, (2) One-Click MPO cleaners	FOCIS-LTNG-U
FOCIS Lightning Kit, soft carry case, AC charger, (1) APC ferrule and bulkhead adapter tip, (2) One-Click MPO cleaners	FOCIS-LTNG-A
FOCIS Lightning Kit, soft carry case, AC charger, (1) UPC and (1) APC ferrule and bulkhead adapter tips, (2) One-Click MPO cleaners	FOCIS-LTNG-UA
FOCIS Lightning Kit, soft carry case, AC charger, (1) UPC and (1) APC ferrule and bulkhead adapter tips, (2) One-Click MPO cleaners, single fiber adapter	FOCIS-LTNG-UAS
FOCIS Lightning No Wireless Kit, soft carry case, AC charger, with no tips or One-Click cleaner	FOCIS-LTNG-NW-N
FOCIS Lightning No Wireless Kit, soft carry case, AC charger, (1) UPC ferrule and bulkhead adapter tip, (2) One-Click MPO cleaners	FOCIS-LTNG-NW-U
FOCIS Lightning No Wireless Kit, soft carry case, AC charger, (1) APC ferrule and bulkhead adapter tip, (2) One-Click MPO cleaners	FOCIS-LTNG-NW-A
FOCIS Lightning No Wireless Kit, soft carry case, AC charger, (1) UPC and (1) APC ferrule and bulkhead adapter tips, (2) One-Click MPO cleaners	FOCIS-LTNG-NW-UA

FOCIS Lightning Adapter Tips and Accessories

DESCRIPTION	TIP ID	AFL NO.
Adapter tip for MPO-12/24 APC bulkhead (with key)	M12A	FLTNG-01-M12A
Adapter tip for MPO-12/24 UPC bulkhead (with key)	M12U	FLTNG-01-M12U
Adapter tip for MPO-16/32 UPC bulkhead (with key)	M16U	FLTNG-01-M16U
Universal adapter tip for MPO-12/16/24/32 APC bulkhead (partial key)	MPA	FLTNG-01-MPA
Universal adapter tip for MPO-12/16/24/32 UPC bulkhead (partial key)	MPU	FLTNG-01-MPU
Adapter tip for MPO-12/16/24/32 UPC bulkhead (no key)	MPOU	FLTNG-01-MPOU
Adapter Tip for MPO-12/16/24/32 APC connector (with key)	MAC	FLTNG-01-MAC
Adapter Tip for MPO-12/16/24/32 UPC connector (with key)	MUC	FLTNG-01-MUC
Adapter Tip for OptiTip male (pinned) connector	OPTM	FLTNG-01-OPTM
Adapter Tip for OptiTip female (unpinned) connector	OPTF	FLTNG-01-OPTF
Coupler for most 'FFLX' single fiber connector adapter tips	SFA	FLTNG-01-SFA
Extended adapter tip for LC-APC bulkhead	ALCM	FLTNG-01-ALCM
Extended adapter tip for LC-UPC bulkhead	ULCM	FLTNG-01-ULCM
MPO extender barrel	MPE	FLTNG-01-MPE

Notes:

- All specifications valid at 23°C ±2°C (73.4°F ±3.6°F).
- Operating conditions: 60 tests in 20 minutes, then auto-off; repeat each hour.

FOCIS Lightning® Multi-Fiber Optic Connector Inspection System

Test Management and Reporting Software

DESCRIPTION	AFL NO.
FOCIS Flex App (Google play or App Store)	Free Download

Recommended Products



FlexScan® FS300 (quad) and FS200 (single-mode) OTDRs

- SmartAuto® 1-button automated testing for fast results
- LinkMap® color-coded icons for easy troubleshooting
- FleXpress® mode (FS200) completes OTDR test in <5 seconds!
- Integrated Source, Power Meter and VFL



One-Click® Cleaner MPO / MPO-16

- Ideal for Data Centers and high density optical networks
- Designed to work on MTP®/MPO multi-fiber connectors
- Cleans connectors on jumpers and in adapters

Qualifications

CATEGORY	REGULATION/STANDARD	QUALIFICATION
CE Marking	EU	Compliant to relevant EU Directives on health, safety, and environmental protection, and certified with CE marking
Safety /EMC /EMI	IEC	Compliant to IEC 61010-1 for safety requirements for electrical equipment
	EN	Compliant to EN 61010-1 for safety requirements for electrical equipment
	IEC	Compliant to IEC 61326-1 for EMC requirements for electrical equipment
	EN	Compliant to EN 61326-1 for EMC requirements for electrical equipment
	EN	Compliant to EN 55011 for EMC requirements for industrial, scientific and medical equipment
	FCC	Compliant to code of federal regulations FCC 47 CFR 15 on unlicensed transmissions
RoHS	EU	Compliant to EU regulations Directive 2011/65/EU (RoHS 2) and Directive 2015/863 (RoHS 3)
Test Method	IEC	Compliant to IEC 61300-3-35 for visual inspection of fiber optic connectors and fiber-stub transceivers
	IPC	Compliant to IPC-8497-1 for cleaning methods and contamination assessment for optical assembly

Contact Sales@AFLglobal.com to schedule a demonstration or learn how to buy.

Visit www.AFLglobal.com/Test to learn more about FOCIS Lightning.

International Sales and Service Contact Information available at www.AFLglobal.com/Test/Contacts.

OFS300 Optical Microscope



Features

- Laser safety filter installed
- 200x image size
- 2.5 mm Universal adapter included
- Long battery life with 2 x AA alkaline
- Rugged, hand-held, easy-to-use

Applications

- Verify connectors are clean prior to connecting to network
- Inspect end-faces for scratches or pits
- Eliminate the most common network fault (bad connectors)

Designed for field use, the OFS300 scope delivers a high-quality end-face image at 200x magnification. It quickly identifies scratches, dirt, or other problems normally associated with poor network performance.

A large percentage of network failures are caused by dirty or damaged end-faces on fiber optic connectors. Inspecting jumper end-faces prior to connection is critical to network performance. The OFS300 scope provides a quality optical inspection tool at an affordable price.

Safe: A built-in laser safety filter provides >40 dB IR protection to reduce risk of injury to the eye if accidentally viewing an active fiber.

Universal adapter: The OFS300 features a Universal adapter cap mount that accepts a variety of thread-on style adapter caps (ordered separately) to easily inspect many connector styles.

Ease-of-use: A momentary power switch located on the top panel keeps one hand free for focusing. For stationary work, the tripod mount allows the OFS300 to attach to any standard tripod.

Long-life: The OFS300 offers 60 hours of continuous battery life from standard 2 x AA batteries and features an LED indicator, which will flash when batteries require replacement.

OFS300 Optical Microscope

Specifications ^a

OPTICAL SPECIFICATIONS	
Nominal Magnification	200X
Adapter Mount	Universal, thread-on
Safety Filter	Schott KG3, >40 dB IR
GENERAL SPECIFICATIONS	
Operating Temperature	0 °C to +50 °C
Storage Temperature	-20 °C to +50 °C
Power	2 x AA batteries
Battery Life	>60 hours
Weight in Use	0.67 kg (1.5 lb)
Size (H x W x D)	13 x 5 x 20 cm (5 x 2 x 8 in)

Note:

a. All specifications valid at 25 °C unless otherwise specified.

Ordering Information

DESCRIPTION	AFL NO.
OFS300 Inspection Kit. Includes OFS300 Inspection Scope, 2 x AA batteries, neck strap, 2.5 mm Universal adapter cap, users guide.	OFS300
OFS300 angled SC adapter tip	8800-00-0220
OFS300 angled FC adapter tip	8800-00-0218
OFS300 angled E2000 adapter tip	8800-00-0229
OFS300 angled MTP/MPO adapter tip	8800-00-0234
OFS300 UPC MTP/MPO adapter tip	8800-00-0233
OFS300 1.25 mm Universal male adapter tip	8800-00-0236
OFS300 2.5 mm Universal male adapter tip	8800-00-0219
OFS300 SMC 0° adapter tip	8800-00-0235
OFS300 1.6 mm (pin) adapter tip	8800-00-0244
OFS300 2.0 mm (pin) adapter tip	8800-00-0248
OFS300 EC (radial) adapter tip	8800-00-0277

Qualifications

CATEGORY	REGULATION/STANDARD	QUALIFICATION
CE Marking	EU	Compliant to relevant EU Directives on health, safety, and environmental protection, and certified with CE marking
Safety /EMC /EMI	IEC	Compliant to IEC 61010-1 for safety requirements for electrical equipment
	EN	Compliant to EN 61010-1 for safety requirements for electrical equipment
	IEC	Compliant to IEC 61326-1 for EMC requirements for electrical equipment
	EN	Compliant to EN 61326-1 for EMC requirements for electrical equipment
	EN	Compliant to EN 55011 for EMC requirements for industrial, scientific and medical equipment
	FCC	Compliant to code of federal regulations FCC 47 CFR 15 on unlicensed transmissions
RoHS	EU	Compliant to EU regulations Directive 2011/65/EU (RoHS 2) and Directive 2015/863 (RoHS 3)

Contact Sales@AFLglobal.com to schedule a demonstration or learn how to buy.

Visit www.AFLglobal.com/Test to learn more about OFS300 Optical Microscope.

International Sales and Service Contact Information available at www.AFLglobal.com/Test/Contacts

OFI-BIPM and OFI-BIPMe Optical Fiber Identifiers



OFI-BIPM

OFI-BIPMe

Features

- World-class signal detection sensitivity
- Positive-stop trigger lock for optimum detection
- Integrated optical power meter
- 2.4" color touchscreen with backlight
- Up to 4 Tones detection (OFI-BIPMe only)

Applications

- Maintenance of fiber optic networks
- Troubleshooting network issues
- Identification of live fibers or trace fibers
- Power levels verification

The OFI-BIPM/-BIPMe optical fiber identifier is an easy-to-use tool that determines if a fiber is live, the transmission direction, and the relative core power on standard and bend-insensitive single-mode and multimode fibers. Its positive-stop trigger mechanism provides the right amount of pressure every time to assure proper detection, while keeping loss to a minimum. This ensures that traffic will not be interrupted and the fiber will not be damaged.

Nicknamed "The Job saver": The OFI-BIPM/-BIPMe removes the need to access the optical fiber at a connection or splice point, eliminating the possibility of interrupting service to a customer.

No heads to change or lose: The universal head of the OFI-BIPM/-BIPMe eliminates the need to change an adapter head for jacketed, coated, or ribbon fibers, making it extremely easy to use in the field.

Integrated optical power meter: The optical power meter mode verifies power levels during installation or troubleshooting.

Color touchscreen: The touchscreen provides simple-to-follow setup instructions and clear results that are easy to read.

Field technician favorite: The OFI-BIPM/-BIPMe is a favorite of technicians for its accuracy, ease of use, integrated power meter, and ergonomic design.

Doesn't damage delicate fibers: The positive-stop trigger ensures that the right pressure is applied every time, while the slim head makes it easier to reach and test tightly-packed fibers without damaging them.

OFI-BIPM and OFI-BIPMe Optical Fiber Identifiers

Specifications^a

OPTICAL (OFI)							
Fiber Type	0.25 mm SM and MM fiber; SM and MM ribbon fiber (up to 12 ribbon fiber) 1.1 mm/1.5 mm/1.7 mm/2.0 mm/3.0 mm SM and jacketed fiber						
Optical Characteristic	Wavelength Range	900 to 1700 nm					
	Detectable Light Signals	CW, Traffic or 270 Hz, 330 Hz (OFI-BIPMe only), 1 kHz, 2 kHz Tone ^b					
Insertion Loss (IL) & Minimum Detect Level ^c at Normal, Fast or Fine operation mode	Wavelength	1310 nm		1550 nm		1650 nm	
	Fiber Type	IL (dB)	Normal/Fast/Fine (dBm)	IL (dB)	Normal/Fast/Fine (dBm)	IL (dB)	Normal/Fast/Fine (dBm)
	0.25 mm (R=30 mm)	0.2	-58/-53/-64	1.0	-67/-62/-73	2.5	-67/-62/-73
	0.25 mm (R=15 mm), Ribbon	0.1	-44/-39/-50	0.3	-57/-52/-63	1.0	-57/-52/-63
	0.5 mm (R=15 mm)	0.2	-58/-53/-64	1.0	-67/-62/-73	2.5	-67/-62/-73
	1.1 mm/1.5 mm Jacketed	0.3	-43/-37/-53	1.0	-55/-50/-61	2.5	-57/-52/-63
	1.7 mm/2.0 mm Jacketed	0.5	-22/-17/-28	2.0	-27/-22/-33	3.0	-27/-22/-33
	3.0 mm Jacketed	1.0	-20/-15/-25	3.0	-23/-18/-28	3.0	-23/-18/-28

POWER METER (OPM)	
Wavelength	1310 nm, 1490 nm, 1550 nm
Detectable Light Signal	CW, Traffic or 270 Hz, 330 Hz (OFI-BIPMe only), 1 kHz, 2 kHz Tone ^b
Detector Sensitivity	+10 to -60 dBm at modulated tone; +10 to -40 dBm at CW or Traffic ^b
Accuracy ^d	±0.3 dB @1310/1550 nm; ±0.6 dB @1490 nm

GENERAL	
Operation Conditions	-10 to +50 °C, 0 to 95 % RH (non-condensing)
Storage Conditions	-20 to +60 °C, 0 to 95 % RH (non-condensing)
Power Supply	2 x AA batteries; 1.2 to 1.5 V DC
Battery Life	8 hours ^e
Dimensions (W x H x D)	5.0 x 11.5 x 21.2 cm (1.9 x 4.5 x 8.3 in) ^f
Weight	230 g (8.1 oz) including battery

Notes:

- a. All specifications valid at 25°C unless otherwise specified.
- b. Traffic is a light signal modulated by a random data sequence.
- c. Typical value. The minimum detect level (core power) the insertion loss varies due to coating material, color, etc.
- d. Under the condition of temperature 25°C with input power at -20 dBm.
- e. Using 2 Alkaline AA Batteries.
- f. Except protruding part.

OFI-BIPM and OFI-BIPMe Optical Fiber Identifiers

Ordering Information

DESCRIPTION	AFL NO.
BI Optical Fiber Identifier with integrated Optical Power Meter. The kit includes one 2.5 mm Universal Power Meter Port Adapter, BIPM-00-25.	OFI-BIPM
BI Enhanced Optical Fiber Identifier with integrated Optical Power Meter. The kit includes one 2.5 mm Universal Power Meter Port Adapter, BIPM-00-25.	OFI-BIPMe
OPTIONAL ADAPTERS (ordered separately)	
2.5 mm Universal Power Meter Port Adapter	BIPM-00-25
SC Power Meter Port Adapter	BIPM-00-SC
FC Power Meter Port Adapter	BIPM-00-FC
ST Power Meter Port Adapter	BIPM-00-ST
LC Power Meter Port Adapter	BIPM-00-LC

Recommended Products



FlexScan® FS300 (quad) and FS200 (single-mode) OTDRs

- SmartAuto® 1-button automated testing for fast results
- LinkMap® color-coded icons for easy troubleshooting
- FleXpress® mode (FS200) completes OTDR test in <5 seconds!
- Integrated Source, Power Meter and VFL



Optical Light Sources

- Encircled Flux Compliant
- 5-Year Product Warranty
- Integrated LED and Laser light sources

Qualifications

CATEGORY	REGULATION/STANDARD	QUALIFICATION
CE Marking	EU	Compliant to relevant EU Directives on health, safety, and environmental protection, and certified with CE marking
Safety /EMC /EMI	IEC	Compliant to IEC 61010-1 for safety requirements for electrical equipment
	EN	Compliant to EN 61010-1 for safety requirements for electrical equipment
	IEC	Compliant to IEC 61326-1 for EMC requirements for electrical equipment
	EN	Compliant to EN 61326-1 for EMC requirements for electrical equipment
	EN	Compliant to EN 55011 for EMC requirements for industrial, scientific and medical equipment
	FCC	Compliant to code of federal regulations FCC 47 CFR 15 on unlicensed transmissions
RoHS	EU	Compliant to EU regulations Directive 2011/65/EU (RoHS 2) and Directive 2015/863 (RoHS 3)

Contact Sales@AFLglobal.com to schedule a demonstration or learn how to buy.

Visit www.AFLglobal.com/Test to learn more about OFI-BIPM/-BIPMe.

International Sales and Service Contact Information available at www.AFLglobal.com/Test/Contacts

Push-Type Cleaners

Cleaning Supplies



SC/ST/FC

MU/LC

Mini-100
SC, ST, FC

Mini-100
MU/LC



Ultra 2.5

D-LC

One-Click® Cleaners

Features

- Patented single-action cleaning in a small ergonomic design
- Variety of sizes and types for different connector styles
- Cleans connectors in both jumpers and bulkhead adapters
- Low cost per clean

Applications

- Removing oil, dust, and dirt without damaging delicate fiber end-faces
- Both dry and wet cleaning (add cleaning fluid)
- Clean connectors in tight spaces
- Field or laboratory use

One-Click Cleaner

Easy-to-use solution for cleaning fiber optic connectors on jumpers and in adapters. Since over 85% of network outages are attributed to dirty and/or damaged connectors, it is critical to clean every connector! The patented One-Click Cleaner uses the mechanical push action to advance an optical grade cleaning tape while the cleaning tip is rotated to ensure the fiber end-face is effectively, but gently, cleaned. It is a favorite of field technicians for its ease of use, durability, effectiveness, and small size.

Compact One-Click Cleaner Mini

Offering the same technology and performance as the original, the One-Click Cleaner mini enables cleaning connectors in tighter places. Its smaller size also makes it a great addition to test kits and cleaning kits. The mini One-Click Cleaners come in both 100+ or 500+ cleans per unit.

One-Click Ultra Cleaner 2.5

The One-Click Ultra Cleaner 2.5 has an enlarged cleaning area to clean more of the connector end-face. Cleaning up to a 2 mm diameter area of the connector end-face, the One-Click Ultra Cleaner 2.5 is a superior cleaner for SC, ST, and FC connectors.

One-Click Cleaner D-LC (Duplex LC)

The One-Click Cleaner D-LC cuts cleaning time in half by effectively cleaning both connectors of a duplex LC connector simultaneously. Available in a long-lasting 500+ clean pen shape.

Push-Type Cleaners

One-Click® Cleaners

One-Click Cleaner MPO and MPO-16

The One-Click Cleaner MPO/MPO-16 is a revolutionary push-type cleaner that simplifies cleaning of the ferrule end-face of MPO/MTP® connector. The One-Click MPO-16 cleans 16-fiber MPO/MTP connectors, both pinned (male) and socketed (female). MPO-16 is used with IEEE 802.3bs 400G trunk cabling with each fiber carrying 25 Gbps data signals (400GBASE-SR16 for example), among other applications.



MPO

MPO-16

One-Click Cleaner CS/MDC Duplex

The One-Click Cleaner CS/MDC cuts cleaning time in half by effectively cleaning both connectors of a duplex CS/MDC at one time.

One-Click Cleaner SN Duplex

The One-Click Cleaner SN cuts cleaning time in half by effectively cleaning both connectors of a duplex SN at one time.

One-Click Cleaner HOC

The Hardened Outdoor Connector (HOC) One-Click Cleaner is an essential cleaning tool for OptiTap®, TITAN RTD®, TRIDENT®, and SC connectors. The new design of the HOC Cleaner allows it to be used for Plug/Receptacle without the need for the conventional guide cap.



CS, MDC

SN Duplex

HOC

Ordering Information

DESCRIPTION	AFL NO.
One-Click Cleaner SC, ST, FC (500+ cleans)	8500-05-0001MZ
One-Click Cleaner MU/LC (500+ cleans)	8500-05-0002MZ
One-Click Cleaner ODC, outdoor connector (500+ cleans)	8500-05-0004MZ
One-Click Cleaner Mini-100 SC, ST, FC (100+ cleans)	8500-05-0005MZ
One-Click Mini-100 MU/LC (100+ cleans)	8500-05-0006MZ
One-Click Cleaner Mini-500 SC, ST, FC (500+ cleans)	8500-05-0009MZ
One-Click Cleaner Mini-500 MU/LC (500+ cleans)	8500-05-0010MZ
One-Click Ultra Cleaner 2.5 (enlarged cleaning) SC, ST, FC (500+ cleans)	8500-05-0007MZ
One-Click Cleaner D-LC, Duplex LC (2 x 500+ cleans)	8500-05-0008MZ
One-Click Cleaner MPO (500+ cleans)	8500-05-0030MZ
One-Click Cleaner MPO-16 (500+ cleans)	8500-05-0013MZ
One-Click Cleaner MT-RJ (500+ cleans)	8500-05-0031MZ
One-Click Cleaner M20, 2.0 mm ferrule (500+ cleans)	8500-05-0014MZ
One-Click Cleaner CS, MDC Duplex (500+ cleans)	8500-05-0015MZ
One-Click Cleaner SN Duplex (500+ cleans)	8500-05-0016MZ
One-Click Cleaner HOC, Hardened Optic Connectors (500+ cleans)	8500-05-0018MZ
BOXES OF 5 UNITS	
One-Click Cleaner SC, ST, FC (box of 5 units)	8500-05-0021MZ
One-Click Cleaner MU/LC (box of 5 units)	8500-05-0022MZ
One-Click Cleaner Mini-100 SC, ST, FC (box of 5 units)	8500-05-0025MZ
One-Click Cleaner Mini-100 MU/LC (box of 5 units)	8500-05-0026MZ
One-Click Ultra Cleaner 2.5 SC, ST, FC (box of 5 units)	8500-05-0027MZ
One-Click Cleaner MPO-16 (box of 5 units)	8500-05-0023MZ

Push-Type Cleaners

Cleaning Supplies



NEOCLEAN-E Models (E1, E2, E3)



NEOCLEAN-M and NEOCLEAN-M2

NEOCLEAN Cleaners

Features

- Push action
- Replaceable cleaning cartridge - 750 cleaning per cartridge (NEOCLEAN-E)
- Low cost per clean

Applications

- Cleans connectors on jumpers or in adapters
- SC, FC, ST, E2000, LC, and MU connectors
- MPO and MTP connectors
- Suitable for field or laboratory use

NEOCLEAN-E uses a push action to clean contamination from the end-face of connectors on jumpers or in adapters. The replaceable cleaning cartridge can perform 750 cleans, reducing cleaning cost.

NEOCLEAN-M is designed for cleaning MPO and MTP multi-fiber connectors used in data centers and other high-density optical networks. It uses a one-push operation, which simplifies cleaning of the ferrule end-face of both MPO and MTP connectors and connectors in adapters.

NEOCLEAN-M2 is designed for cleaning MPO-16 and MTP-16 multi-fiber multi-row connectors used in data centers and other high-density optical network environments.

Ordering Information

MODEL	APPLICABLE CONNECTORS & DESCRIPTION	# OF CLEANS	AFL NO.
NEOCLEAN-E1	For MU, LC with UPC/APC polishes	750+	8500-15-0900MZ
NEOCLEAN-E2	For SC,FC with UPC/APC polishes; OptiTap		8500-15-0901MZ
NEOCLEAN-E3	For SC, ST, FC, E2000 with UPC/APC polishes; OptiTap		8500-15-0902MZ
NEOCLEAN-ES1	Pack of 3 replacement cartridges for NEOCLEAN-E1		8500-15-0903MZ
NEOCLEAN-ES2	Pack of 3 replacement cartridges for NEOCLEAN-E2		8500-15-0904MZ
NEOCLEAN-ES3	Pack of 3 Replacement cartridges for NEOCLEAN-E3		8500-15-0905MZ
NEOCLEAN-M	For MPO/MTP	600+	8500-15-0909MZ
NEOCLEAN-M2	For MPO-16/MPT-16		8500-15-0910MZ

Recommended Products



FOCIS Flex Connector Inspection

- Self-contained, tether-free, hand-held
- Auto-focus and auto-centering for fast, easy inspection
- IEC, IPC and user-defined pass/fail analysis



Cletop Cleaners

- Simple push-button shutter application
- Easily replaceable cost-effective tape cartridges
- Over 400 wipes per tape



FCC2 Cleaning Fluid

- Unique dispenser for use with AFL Connector Cleaning Tips and FiberWipes
- Dissipates static charge
- Up to 400+ cleanings per can

Contact Sales@AFLglobal.com to schedule a demonstration or learn how to buy.

Visit www.AFLglobal.com/Clean to learn more about Push-Type Cleaners.

International Sales and Service Contact Information available at www.AFLglobal.com/Test/Contacts

CleTOP Optical Fiber Connector Cleaner



Features

- Simple push-button shutter application
- Compact lightweight design
- Easily replaceable cost-effective tape cartridges
- Over 400 wipes per tape

Applications

- Ideal for labs, assembly lines, and field use
- Cleans a wide variety of connector types
- Excellent anti-static properties for static sensitive applications

The CleTOP Optical Fiber Connector Cleaner is a rugged palm-sized cleaner that offers exceptional performance with a proven track record. The choice of many leading manufacturers and telecom carriers worldwide for nearly 20 years, CleTOP is a name you can rely on.

CleTOP Options

- CleTOP Series – Original
- CleTOP –S Series - Second generation cleaner offering “Drop-in” replacement tape cartridge and ergonomic design
- Type A & -SA - Designed for single 2.5mm ferrules (SC, FC, ST, & D4)
- Type B & -SB - Cleans SC, SC2, FC, ST®, DIN, D4, MU, LC, MT, MPO/MTP® without pins

Ordering Information

DESCRIPTION	AFL NO.
CLETOP – S SERIES	
CleTOP -SA with Blue Tape	8500-10-0020MZ
CleTOP -SB with Blue Tape	8500-10-0029MZ
CleTOP -SB with White Tape	8500-10-0016MZ
Replacement Tape Type S - Blue	8500-10-0021MZ
Replacement Tape Type S - White	8500-10-0017MZ

DESCRIPTION	AFL NO.
CLETOP ORIGINAL SERIES	
CleTOP Type A with Blue Tape	8500-10-0027MZ
CleTOP Type A with White Tape	8500-10-0011MZ
CleTOP Type B with Blue Tape	8500-10-0028MZ
CleTOP Type B with White tape	8500-10-0014MZ
CleTOP for MT-RJ with pins (White Tape)	8500-10-0032MZ
CleTOP for MPO/MTP with pins (White Tape)	8500-10-0033MZ
Replacement Tape Blue	8500-10-0012MZ
Replacement Tape White	8500-10-0015MZ

Recommended Products



Cleaning Kits

- Complete kits for cleaning variety of connectors
- Includes wet and dry cleaning products
- Convenient refill options



One-Click® Cleaners

- Patented single-action
- Variety of sizes and types
- Low cost per clean



WFW FiberWipes™

- Lint free and fully optical grade
- Robust and tear-resistant
- Softer than traditional cellulose wipes

Contact Sales@AFLglobal.com to schedule a demonstration or learn how to buy.

Visit www.AFLglobal.com/Clean to learn more about CleTOP Optical Fiber Connector Cleaners.

International Sales and Service Contact Information available at www.AFLglobal.com/Test/Contacts

Cleaning Fluids and Wipes

FCC2 Enhanced Fiber Connector Cleaner and Preparation Fluid

Cleaning Supplies



Features

- Not Hazardous/Not Regulated for all modes of transport, including air cargo
- Unique dispenser for use with AFL Connector Cleaning Tips and FiberWipes™
- Dissipates static charge
- Up to 400+ cleanings per can

Applications

- Cleans of all types of connector end-faces
- Cleans bare fiber before field terminating or fusion splicing
- Removes oils, salts, dust, dirt, and uncured epoxies
- Safe on glass, ceramic, metal, plastic optical fiber

FCC2 Enhanced Fiber Connector Cleaner and Preparation Fluid is a nonflammable, environmentally safe, residue-free solvent engineered to clean fiber connector end-faces and bare fiber. The 3-way dispenser provides easy one-handed use as tap dispenser for fiber wipes, a well for CCT Connector Cleaning Tips, and a spray nozzle for larger areas. Packaged in a spill-proof container, it can be shipped with connector cleaning and termination kits providing everything techs need in the field. FCC2 was developed with Micro Care Corporation, a world leader in cleaning solvents.

Ordering Information

DESCRIPTION	AFL NO.
Fiber Connector Cleaner and Preparation Fluid in 3 oz / 85 g can	FCC2-00-0902
Fiber Connector Cleaner and Preparation Fluid , Case of 12 cans	FCC2-00-0903

Recommended Products



FOCIS Flex Connector Inspection

- Self-contained, tether-free, hand-held
- Auto-focus and auto-centering for fast, easy inspection
- IEC, IPC and user-defined pass/fail analysis



One-Click® Cleaners

- Patented single-action
- Variety of sizes and types
- Low cost per clean



Cleto Cleaners

- Simple push-button shutter application
- Easily replaceable cost-effective tape cartridges
- Over 400 wipes per tape

Cleaning Fluids and Wipes

Debris Destroyer® Fiber Cleaning Pen



Features

- Precise applicator tip for controlled cleaning
- Eliminates electrostatic charge
- Designed for use with One-Click® Cleaners, FiberWipes™, CleanWipes™
- Safe for plastic components

Applications

- Cleaning fiber optic connector end-faces and bare fiber
- Wet to dry cleaning with wipes and One-Click cleaners
- Ideal for bare fiber preparation prior to fusion splicing
- Remove dirt, dust, oils, and other debris from fiber optic components

The Debris Destroyer is a cleaning pen for fiber optic connectors and bare fiber. It can be used for controlled application of cleaning fluid to cassette cleaners and wipes. AFL offers multiple products that can be used with the Debris Destroyer, including CLETOP-S, OPTIPOP-R, FiberWipe, and CleanWipe. The Debris Destroyer can also be used to moisten the tip of One-Click cleaners, turning them into a wet cleaning solution for tough end-face contamination.

Ordering Information

DESCRIPTION	AFL NO.
Debris Destroyer Fiber Cleaning Pen, 9 grams/0.32 oz.	FCC3-00-PEN1

Recommended Products



FOCIS Flex Connector Inspection

- Self-contained, tether-free, hand-held
- Auto-focus and auto-centering for fast, easy inspection
- IEC, IPC and user-defined pass/fail analysis



CleTOP Cleaners

- Simple push-button shutter application
- Easily replaceable cost-effective tape cartridges
- Over 400 wipes per tape



One-Click® Cleaners

- Patented single-action
- Variety of sizes and types
- Low cost per clean

Cleaning Fluids and Wipes

Optical Cloth Wipes

Cleaning Supplies



FiberWipes

Features

- Lint free and fully optical grade
- Robust and tear-resistant
- Softer than traditional cellulose wipes

Applications

- Cleaning optical fibers prior to termination or splicing
- Cleaning fiber optic connector ferrule end-faces
- Cleaning lenses, mirrors, and other optical surfaces
- Use for wet cleaning with FCC2 Connector Cleaning Fluid or FCC3 Fiber Cleaning Pen

Specifically designed to lift and trap common contaminants found in fiber optic installations, AFL wipes provide superior cleaning results because they are made from material that is stronger, softer, and more absorbent than traditional cellulose wipes. Packaged in a clean room, the fabric is optical-quality grade and comes in two convenient form factors and are perfect additions to both tool kits and test kits.

WFW FiberWipes™

- Rugged 90-wipe mini-tub ideal for laboratory and field use
- Hexagonal cover minimizes rolling distance when dropped
- Solvent safe – wipes may be moistened to provide wet / dry cleaning

FiberAide 1

- Hermetically sealed wipes remain uncontaminated and ready for use
- Foil-backed wipes protect skin from cleaning solvents and cable gel
- Packaging contains no glues to leach out
- Solvent safe – wipes may be moistened to provide wet / dry cleaning



FiberAide 1

Ordering Information

DESCRIPTION	AFL NO.
FiberWipes – case of 24 mini-tubs (2160 total wipes, 90 wipes per mini-tub)	9000-03-0026MZ
FiberAide 1 – case of 600 packets (60 bundles, 10 packets per bundle)	9000-03-0027MZ

Recommended Products



FOCIS Flex Connector Inspection

- Self-contained, tether-free, hand-held
- Auto-focus and auto-centering for fast, easy inspection
- IEC, IPC and user-defined pass/fail analysis



Cleto Cleaners

- Simple push-button shutter application
- Easily replaceable cost-effective tape cartridges
- Over 400 wipes per tape



One-Click® Cleaners

- Patented single-action
- Variety of sizes and types
- Low cost per clean

Contact Sales@AFLglobal.com to schedule a demonstration or learn how to buy.

Visit www.AFLglobal.com/Clean to learn more about Cleaning Fluids and Wipes.

International Sales and Service Contact Information available at www.AFLglobal.com/Test/Contacts

Cleaning Kits



FCP1 Kit



FCP2 Kit



FCP3 Kit

Features

- Mix of wet and dry cleaning products for most applications
- MPO/MTP® Option
- Field portable
- Convenient refill options

Applications

- Field cleaning connectors on jumpers and through bulkhead adapters
- Clean SC, ST, FC, LC, MU, and MPO connectors
- Clean a variety of contaminants

Cleaning saves time and money! Over 85% of network failures can be traced back to dirty and damaged connectors. The foolproof way to avoid these outages is to inspect and clean every connector, every time - without fail. You should even inspect new ones right out of the box. Proper fiber hygiene can extend the life of connectors and reduces replacement costs. FCP Cleaning Kits from AFL offer a complete selection of fiber optic cleaning products for field cleaning of connector end-faces in a convenient carry case.

FCP1 kits consist of a wall or rack mountable carry case, FCC2 Fiber Connector Cleaner and Preparation Fluid, CCT Connector Cleaning Tips, Cletop-SB, and color-coded instructions.

FCP2 kits include FCC2 Fiber Connector Cleaner and Preparation Fluid, FCC3 Debris Destroyer® Fiber Cleaning Pen, WFW FiberWipes™, Cletop SB, One-Click Cleaners for SC, ST, FC, LC/MU, MPO connectors, and a field portable duffel bag.

FCP3 kits include FCC2 Fiber Connector Cleaner and Preparation Fluid, FCC3 Debris Destroyer® Fiber Cleaning Pen, CCT Connector Cleaning Tips, Cletop-SB, One-Click Cleaners for SC, ST, FC, LC/MU, MPO connectors, and an easy-access soft carry case.

Cleaning Kits

Ordering Information

FCP1 WALL/RACK MOUNTABLE FIELD PORTABLE CLEANING KITS	AFL NO.		
	FCP1-00-0901	FCP1-00-0907	FCP1-00-0914
CONTENTS / ITEMS DESCRIPTION			
FCC2 Fiber Connector Cleaner And Preparation Fluid (Can)	◆	◆	◆
CCTS-12 (for 1.25 mm ferrule) Connector Cleaning Tips		◆	◆
CCTS-25 (for 2.5 mm ferrule) Connector Cleaning Tips	◆	◆	◆
CCTP-25 (for all connectors) Connector Cleaning Tips	◆	◆	◆
CCTX-MT (for MTP, MPO, MPX connectors) Connector Cleaning Tips		◆	
Cletop-S, Type B with White Tape	◆	◆	◆
Color-coded Instructions	◆	◆	◆
Wall/Rack Mountable Carry Case	◆	◆	◆

FCP2 FIELD PORTABLE DUFFLE BAG CLEANING KITS	AFL NO.	
	FCP2-10-0900	FCP2-00-0901
CONTENTS / ITEMS DESCRIPTION		
FCC2 Fiber Connector Cleaner and Preparation Fluid (Can)	◆	◆
FCC3 Debris Destroyer® Fiber Cleaning Pen	◆	◆
WFW FiberWipes™	◆	◆
Cletop-S, Type B with White Tape	◆	◆
One-Click Cleaner SC, ST, FC	◆	◆
One-Click Cleaner MU/LC	◆	◆
One-Click Cleaner MPO		◆
Field Portable Duffle Bag	◆	◆

FCP3 EASY-ACCESS CLEANING KITS	AFL NO.	
	FCP3-00-0900	FCP3-00-0901
CONTENTS / ITEMS DESCRIPTION		
FCC2 Fiber Connector Cleaner And Preparation Fluid (Can)	◆	◆
FCC3 Debris Destroyer® Fiber Cleaning Pen	◆	◆
CCTS-12 (for 1.25 mm ferrule) Connector Cleaning Tips	◆	◆
CCTS-25 (for 2.5 mm ferrule) Connector Cleaning Tips	◆	◆
Cletop-S, Type B with White Tape	◆	◆
One-Click Cleaner SC, ST, FC	◆	
One-Click Cleaner MU/LC	◆	◆
One-Click Cleaner Ultra 2.5 (enlarged cleaning) SC, ST, FC	◆	◆
One-Click Cleaner D-LC, Duplex LC		◆
One-Click Cleaner MPO	◆	◆
Soft Carry Case	◆	◆

Recommended Products



FOCIS Flex & FOCIS Lightning (Multi-fiber) Connector Inspection

- Self-contained, tether-free, hand-held inspection solution
- Auto-focus and auto-centering for fast, easy inspection
- IEC, IPC and user-defined pass/fail analysis
- FOCIS Lightning: extremely fast multi-fiber auto-analysis for datacom and telecom inspection applications



FOCIS WiFi2™ Fiber Optic Connector Inspection

- Trim, lightweight, ergonomic and highly productive tool
- App-based automatic and manual focus; auto-centering after image capture
- One button workflow using rapid LED feedback on probe
- Multi-color LED on probe for fast pass/fail user inspection feedback

Contact Sales@AFLglobal.com to schedule a demonstration or learn how to buy.

Visit www.AFLglobal.com/Clean to learn more about Cleaning Kits.

International Sales and Service Contact Information available at www.AFLglobal.com/Test/Contacts



Visit Our New Resource Center!

As an end-to-end solutions provider, AFL has a vast amount of content on the many aspects of fiber optic networks for a variety of broadband and telecom applications—now in one easy-to-find location. Introducing the new resource center, which provides quick and easy viewing of everything “AFL.” Everything from instructional videos to best practices for test and inspection as well as:

- White Papers on industry-related technology and applications
- Quick access to brochures and PDFs
- Articles and blog posts on application-specific topics
- Video tutorials and instructions on various products

Explore the new AFL resource center and discover all that it has to offer! Go to learn.AFLglobal.com

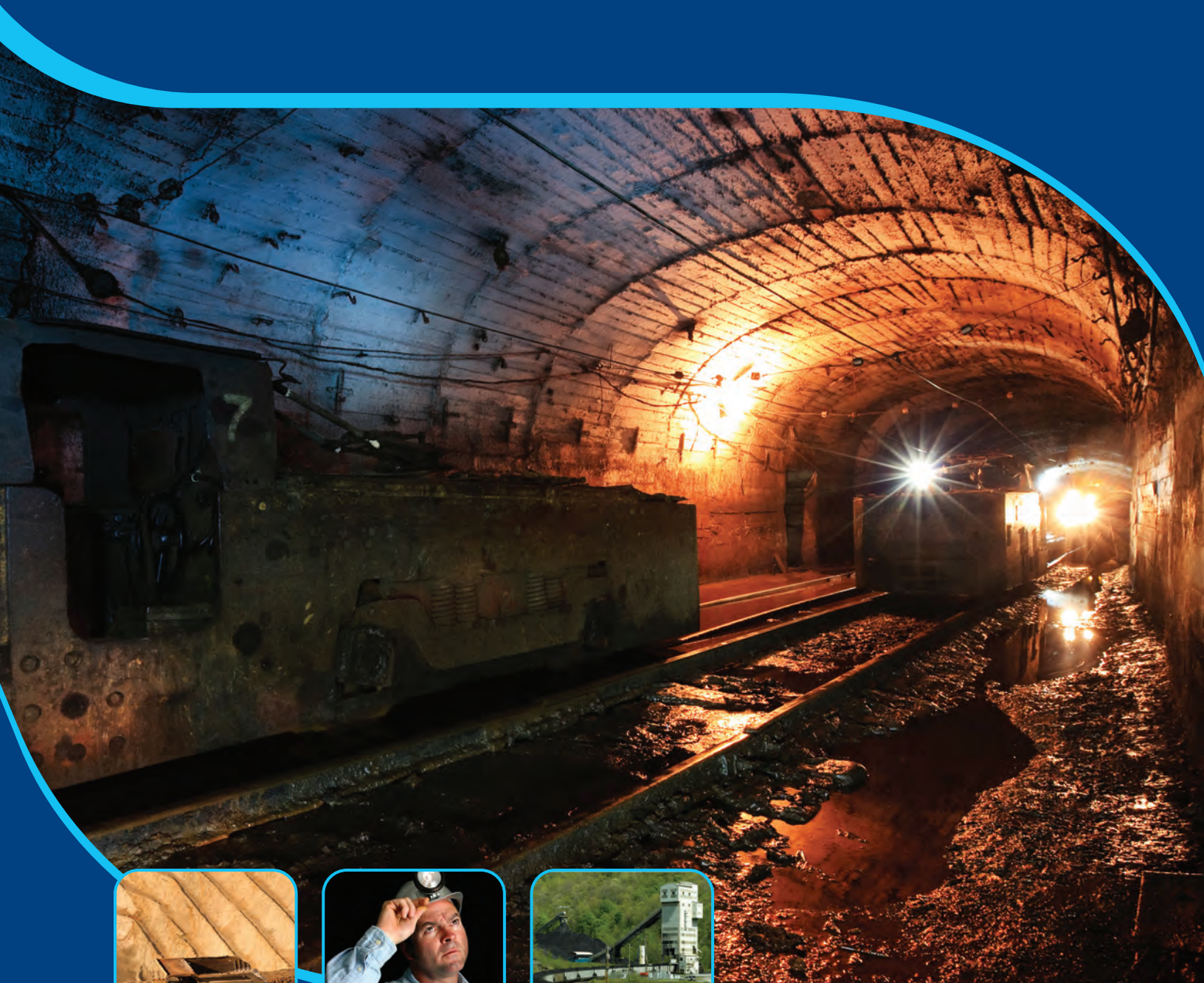

AFL

www.AFLglobal.com

CAT-01202 1.25.2022