Installation Instructions

SOLO HD™ Compression System

Adjustable Clevis Dead End

for Use on Overhead Conductor Types

ACSR, ACSS, ACSS/TW



NOTE:

EXCEPT AS MAY BE OTHERWISE PROVIDED BY CONTRACT, THESE DRAWINGS AND/OR SPECIFICATIONS ARE THE PROPERTY OF AFL, ARE ISSUED IN STRICT CONFIDENCE, AND SHALL NOT BE REPRODUCED OR COPIED OR USED AS THE BASIS FOR MANUFACTURE OR SALE OF PRODUCT WITHOUT PERMISSION.

Preparation

Prior to making connections, the conductor and accessory bore must be clean.

NOTE: Improper cleaning of conductor strands can result in higher resistance dead ends; this causes the fittings to operate at higher temperatures leading to premature failure.

Clean conductor strands thoroughly by using one of the methods below:

Method 1 – ConductaClean® System (Recommended)

ConductaClean solution cleans ends of overhead conductor prior to assembly and removes oxidation and contaminants from strands.

See information on [ConductaClean](https://www.aflglobal.com) at [AFLglobal.com](https://www.aflglobal.com) or call: 800-866-7385 Ref: Transmission tool CCP-SYS_T.

Method 2 – Wire Brush

Clean conductor strands thoroughly with wire brush. Wire brush “new” conductor also.

Check accessory bore for foreign particles, removing if present.

Follow Installation Instructions carefully. Improper installation can result in mechanical failure of the cable system and possible injury to persons handling or in the vicinity of the cable system.



Prior to cutting, wrap tape around the conductor to help maintain the round contour, making it easier to slide the end through the aluminum dead end. File approximately 0.09 inch chamfer on the end of the conductor. (The larger the chamfer, the easier the conductor will slide through).

Straighten several feet of the conductor removing the set caused by the reel.

Assembly

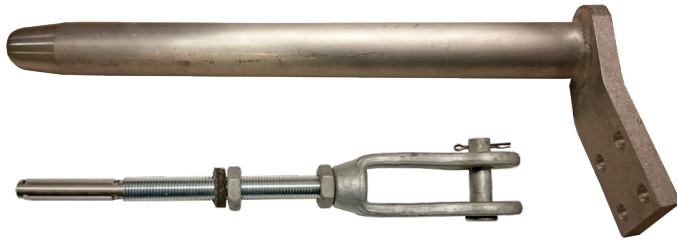

Dead end assemblies consist of an aluminum body and steel adjustable clevis/"core grip". (Felt washer is included as part of clevis assembly.)



STEEL ADJUSTABLE CLEVIS/"CORE GRIP"



ALUMINUM BODY

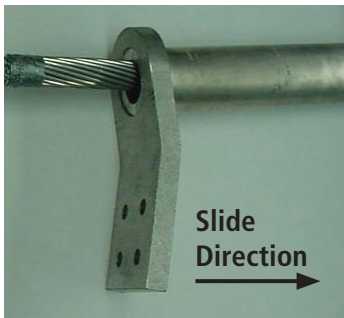

Slide aluminum dead end body (barrel first) over the conductor until sufficient working length protrudes from tongue end.

Cutting Back Aluminum Strands for Installation of Adjustable Clevis/"Core Grip"

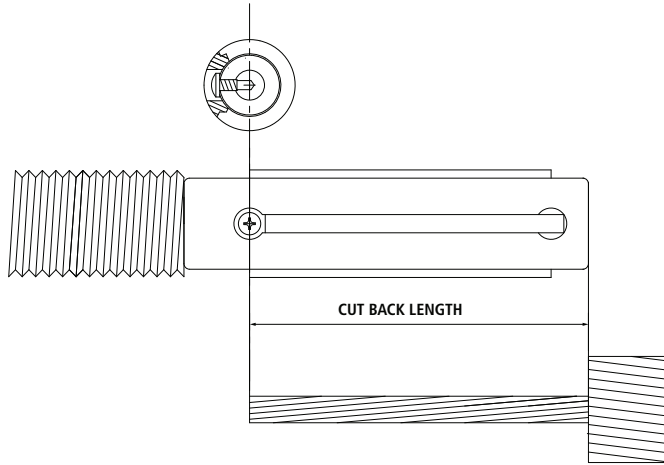

NOTE: It is extremely important not to nick the core strands during cutting back of the aluminum strands. If this is done, the ultimate strength of the dead end will be reduced. The cable manufacturer suggests the following method of cutting back the strands.

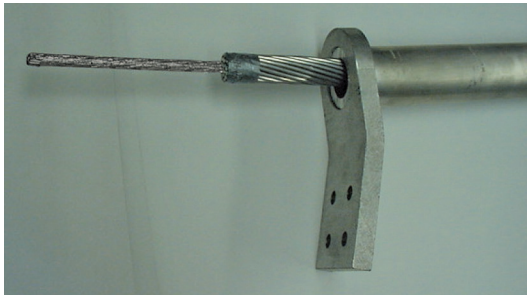

Suggested Method of Cutting Back Aluminum Strands

1. Tape location where "cutting back" is needed.
2. Position RIGID cable trimmer around conductor at the tape location.
3. Cut outer aluminum strands by rotating tool until layer becomes loose.
4. Remove cut outer aluminum layer strand.
5. Bend inner layer wires back and forth until they fracture.
6. Remove the broken wires.



Suggested Arrangement of Compressor and Accessory During Field Installation of Dead End

The photo at right illustrates a setup, which works well to ensure a straight compression and easy maneuverability of the compressor. The conductor has been "tied off" to the tower with a sling and chain wench. The compressor is then attached to the sling by a large shackle (The compressor is suspended upside down). The accessory and cable are tied to the sling ensuring all parts are straight and in-line. The compressor can easily be slid along to each successive compression.



File chamfer on end of core and end of aluminum strands to remove burrs and sharp edge. Chamfer will reduce the expanded diameter of the core (due to cutting) and ease the installation of the adjustable clevis/"core grip".

Assembly

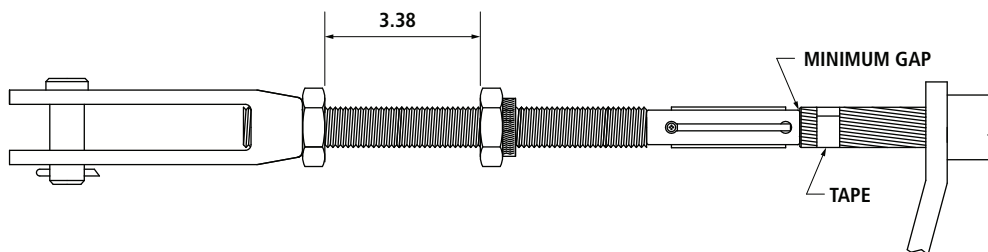

Insert end of conductor into "core grip" of clevis assembly. Rotate clevis assembly "back and forth" while pushing it onto conductor core.



Remove tape from ends of aluminum strands.

Adjust distance between Jam Nuts to 3.38 inches (86 mm) as shown in the illustration above.

Slide aluminum dead end body over adjustable clevis/"core grip" until tongue butts solidly against felt washer and nut.

Push to verify internal parts have remained tight during positioning of aluminum dead end body (See below), then place a mark at the end of barrel.

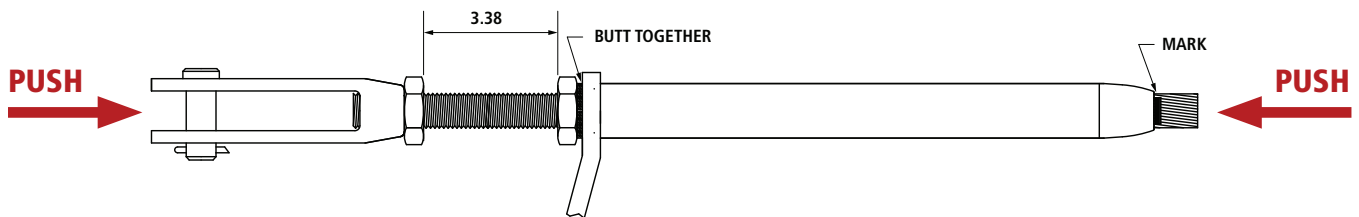

Align clevis in desired orientation of dead end to ensure proper positioning when dead end is fastened to insulator hardware. Lock in place with adjacent jam nut.

Select die size to compress aluminum dead end body. Die size for aluminum dead end body and die size marked on the die must be the same.

The dead end will bow during compression unless reasonable care is taken to have about 15 ft. (4.5 m) of the conductor supported straight out from the end of the dead end.

NOTE: Filler compound is not required in dead end due to its void-free internals (See supporting test data available from AFL).

Compressing

Lubricate area to be compressed from "Start" knurl to end of barrel with "Accu-Lube" or similar lubricant, or cover barrel with accessory plastic wrapper.

Verify mark place at end of barrel has remained where originally place. If not, push internals together prior to making first compression (see illustration above).



Make initial compression on the dead end body over the steel threads beginning at the start knurl near the tongue. Continue making compressions overlapping the previous compression by approximately 0.50 inch. Complete die closure is required for each compression. Continue compressing to end of dead end barrel.

Compressing (cont.)



Compressed portion of the dead end should have a smooth uniform appearance. Remove flash, if present with file or emery cloth.

CAUTION: Follow installation instructions carefully. Improper installation can result in mechanical failure of the cable system and possible injury to persons handling or in the vicinity of the cable system.

Installation of Terminal Connector



Terminal assemblies consist of Terminal Connector and attachment hardware. The terminal comes prefilled with compound from the factory.

See "Preparation" on page 2 for notes on preparation of conductor.

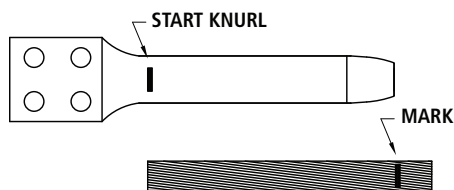

Mark the conductor from the end, a distance equal to the compression length of the terminal.

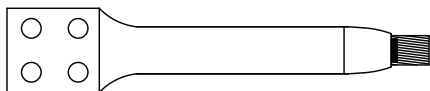

Insert conductor into terminal. Be sure the conductor is inserted to the mark on the conductor.

Select die size to compress Terminal Connector. Die size for Terminal Connector and die size marked on the die must be the same.

Compressing

Lubricate area to be compressed from “Start” knurl to end of barrel with “Accu-Lube” or similar lubricant, or cover barrel with accessory plastic wrapper.



Press the Terminal Connector over the conductor. Make the initial compression at the start knurl. Continue making compressions to the end of the Terminal Connector barrel, overlapping the previous compression by approximately 0.50 inches. Complete die closure is required for each compression.



Compressed portion of the Terminal Connector should have a smooth uniform appearance. Remove flash, if present, with file or emery cloth.

Clean contact surface of Terminal Connector and Dead End pad.

Coat surfaces with AFL Alnox Electrical Joint Compound or AFL HiTemp® Universal Compound and then wire brush through compound. Do not remove coating.

Bolt Terminal Connector to Dead End pad. Partially tighten all bolts and then re-tighten each bolt to recommended torque. Aluminum Bolts: (1/2" bolts – 25 lbf-ft (34 N.m); 5/8" bolts – 40 lbf-ft (54 N.m).

CAUTION: Follow Installation Instructions carefully. Improper installation can result in mechanical failure of the cable system and possible injury to persons handling or in the vicinity of the cable system.